

Circuit Breaker for Equipment thermal, THT terminals for PCB mounting horizontal, 1 pole

new



See below:

Approvals and Compliances

Description

- Thermal circuit breaker
- 1-pole
- On request available with elevated glow-wire ratings
- THT connectors

Unique Selling Proposition

- Reset type
- Cycling trip-free release
- Compact design
- Different mounting possibilities

Applications

- Power supplies
- Uninterruptible power supply
- Power tools
- Industrial appliances
- HVAC
- Household appliances

Weblinks

[pdf data sheet](#), [html datasheet](#), [General Product Information](#), [Distributor-Stock-Check](#), [Detailed request for product](#), [Product News](#), [Video](#)

Technical Data

Rated Voltage AC	240 VAC
Rated Voltage DC	48/32 VDC
Rated current	3-15 A, see approbations
Conditional short circuit capacity Inc	IEC 60934: PC1, AC 240 V: 2 kA
	UL / CSA: SC, AC 240 V DC 48 / 32 V: 2 kA, C1
Degree of protection front side	IP40
Endurance minimum	IEC: 200% I _r , cos φ 0.6: min. 50 switching cycles
Endurance typical	3-8 A: 150% I _r , cos φ 0.9: 2500 switching cycles 10-15 A: 150% I _r , cos φ 0.9: 6000 switching cycles
Dielectric Strength	1500 VAC
Insulation Resistance	500 VDC > 1000 MΩ

Allowable Operation Temp.	3 A: -5 °C to 60 °C
	4 A: -5 °C to 50 °C
	5-15 A: -5 °C to 60 °C
Soldering Methods	Wave
Solderability	245 °C / 3 sec acc. to IEC 60068-2-20 / Test Ta, method 1
Resistance to Soldering Heat	260 °C / 10 sec acc. to IEC 60068-2-20 / Test Tb, method 1A
Weight	approx. 12.5 g

Approvals and Compliances

Detailed information on product approvals, code requirements, usage instructions and detailed test conditions can be looked up in [Details about Approvals](#)

SCHURTER products are designed for use in industrial environments. They have approvals from independent testing bodies according to national and international standards. Products with specific characteristics and requirements such as required in the automotive sector according to IATF 16949, medical technology according to ISO 13485 or in the aerospace industry can be offered exclusively with customer-specific, individual agreements by SCHURTER.

Approvals





The approval mark is used by the testing authorities to certify compliance with the safety requirements placed on electronic products.

Approval Reference Type: T9

Approval Logo	Certificates	Certification Body	Description
	VDE Approvals	VDE	VDE Certificate Number: 40038016
	UL Approvals	UL	UR File Number: E71572
	CCC Approvals	CCC	CCC Certificate Number: 2020970307003348

Product standards

Product standards that are referenced

Organization	Design	Standard	Description
	Designed according to	IEC 60934	Circuit-breakers for equipment (CBE)
	Designed according to	UL 1077	Standard for Supplementary Protectors for Use in Electrical Equipment
	Designed according to	CSA C22.2 No. 235	Supplementary Protectors
	Designed according to	GB 17701	Circuit-breaker for equipment





Application standards

Application standards where the product can be used

Organization	Design	Standard	Description
	Suitable for applications acc.	IEC/UL 62368-1	Audio/video, information and communication technology equipment - Part 1: Safety requirements

Compliances

The product complies with following Guide Lines

Identification	Details	Initiator	Description
	CE declaration of conformity	SCHURTER AG	The CE marking declares that the product complies with the applicable requirements laid down in the harmonisation of Community legislation on its affixing in accordance with EU Regulation 765/2008.
	UKCA declaration of conformity	SCHURTER AG	The UKCA marking declares that the product complies with the applicable requirements laid down in the British Amendment of Regulation (EC) 765/2008.
	RoHS	SCHURTER AG	Directive RoHS 2011/65/EU, Amendment (EU) 2015/863
	China RoHS	SCHURTER AG	The law SJ / T 11363-2006 (China RoHS) has been in force since 1 March 2007. It is similar to the EU directive RoHS.
	REACH	SCHURTER AG	On 1 June 2007, Regulation (EC) No 1907/2006 on the Registration, Evaluation, Authorization and Restriction of Chemicals 1 (abbreviated as "REACH") entered into force.

Dimension [mm]

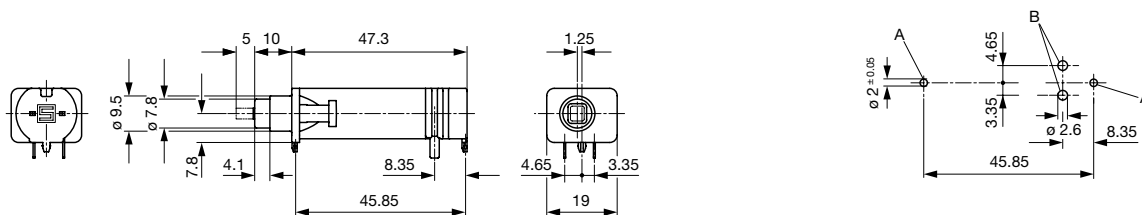



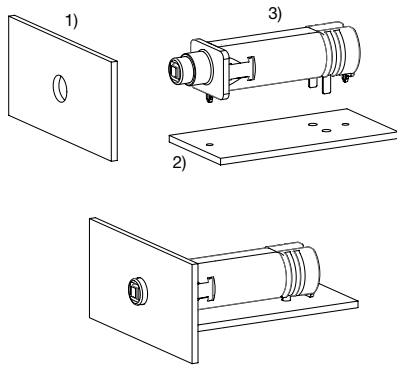

- A Mechanical standoff
- B Electrical terminal

Drilling diagram

Assembly Instructions



- 1) Front panel
- 2) PCB
- 3) T9-818

Approval		Rated current	Rated Voltage AC	Rated Voltage DC
 US	UL 1077	3 - 12 A 14 - 15 A	240 V 240 V	48 V 32 V
 US	CSA 22.2 235	3 - 12 A 14 - 15 A	240 V 240 V	48 V 32 V
	IEC 60934	3 - 12 A 14 - 15 A	240 V 240 V	48 V 32 V
	GB 17701	3 - 12 A 14 - 15 A	240 V 240 V	48 V 32 V

Typical internal resistance per pole

Rated Current [A]	Internal Resistance [mΩ]
3	80.0
4	26.3
5	24.1
6	19.0
7	18.0
8	14.8
10	13.0
12	12.7
14	9.7
15	8.0

Time-Current-Curves

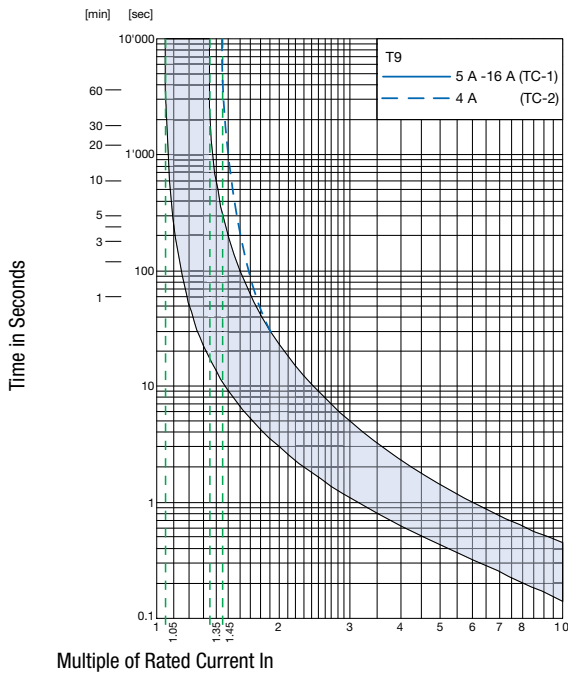

Multiple of Rated Current In

Ambient temperature +23°

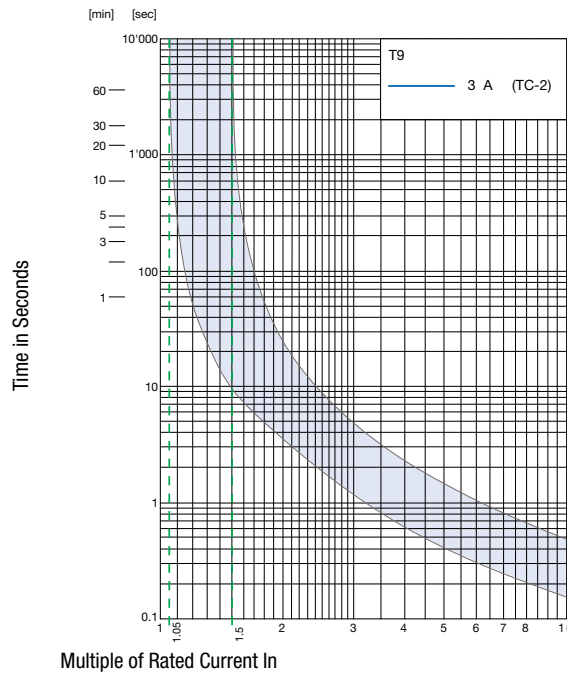

Multiple of Rated Current In

Ambient temperature +23°

Effect of ambient temperature

The units are calibrated for an ambient temperature of +23°C. To determine the rated current for a lower or higher ambient temperature, use a correction factor (typical value) from the table below:

Ambient Temperature [°C]	Correction factor
-5	0,85
+10	0,95
+23	1,00
+40	1,08
+60	1,21

Example: Rated current = 10 A, Environmental temperature = 60 °C, --> Correction factor = 1.21, Resulting current = 12.1 A --> Round to next higher rated current: 13 A

Variants

Connection type	Rated current	Order Number	
Solder / THT	3A	4404.0096	■
Solder / THT	4A	4404.0097	■
Solder / THT	5A	4404.0098	■
Solder / THT	6A	4404.0099	■
Solder / THT	7A	4404.0100	
Solder / THT	8A	4404.0101	
Solder / THT	10A	4404.0102	■
Solder / THT	12A	4404.0103	■
Solder / THT	14A	4404.0104	
Solder / THT	15A	4404.0105	■

■ Most Popular.

Availability for all products can be searched real-time: <https://www.schurter.com/en/Stock-Check/Stock-Check-SCHURTER>

Packaging Unit

100 Pcs