

C3M0015065D

Silicon Carbide Power MOSFET
C3M™ MOSFET Technology
N-Channel Enhancement Mode

Features

- 3rd Generation SiC MOSFET technology
- High blocking voltage with low on-resistance
- High speed switching with low capacitances
- Fast intrinsic diode with low reverse recovery (Qrr)
- Halogen free, RoHS compliant

Benefits

- Higher system efficiency
- Reduced cooling requirements
- Increased power density
- Increased system switching frequency
- Easy to parallel and simple to drive
- Enable new hard switching PFC topologies (Totem-Pole)

Applications

- EV charging
- Solar PV Inverters
- UPS
- SMPS
- DC/DC converters

Package

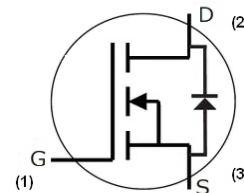
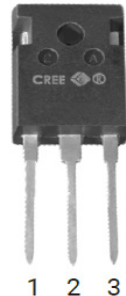

Part Number	Package	Marking
C3M0015065D	TO-247-3	C3M0015065D

Maximum Ratings ($T_c=25^\circ\text{C}$, unless otherwise specified)

Symbol	Parameter	Value	Unit	Note
V_{DSmax}	Drain - Source Voltage	650	V	
V_{GSmax}	Gate - Source voltage	-8/+19	V	Note 1
I_D	Continuous Drain Current, $V_{GS} = 15\text{ V}$, $T_c = 25^\circ\text{C}$	120	A	Fig. 19 Note 2
	Continuous Drain Current, $V_{GS} = 15\text{ V}$, $T_c = 100^\circ\text{C}$	96		
$I_{D(pulse)}$	Pulsed Drain Current, Pulse width t_p limited by T_{jmax}	418	A	
P_D	Power Dissipation, $T_c=25^\circ\text{C}$, $T_j = 175^\circ\text{C}$	416	W	Fig. 20
T_j, T_{stg}	Operating Junction and Storage Temperature	-40 to +175	$^\circ\text{C}$	
T_L	Solder Temperature, 1.6mm (0.063") from case for 10s	260	$^\circ\text{C}$	
M_d	Mounting Torque, (M3 or 6-32 screw)	1	Nm lbf-in	
		8.8		

Note (1): Recommended turn off / turn on gate voltage $V_{GS} = -4\text{V} \dots 0\text{V} / +15\text{V}$

Note (2): Package limited to 120 A

Electrical Characteristics ($T_c = 25^\circ\text{C}$ unless otherwise specified)

Symbol	Parameter	Min.	Typ.	Max.	Unit	Test Conditions	Note
$V_{(BR)DSS}$	Drain-Source Breakdown Voltage	650			V	$V_{GS} = 0\text{ V}, I_D = 100\ \mu\text{A}$	
$V_{GS(th)}$	Gate Threshold Voltage	1.8	2.3	3.6	V	$V_{DS} = V_{GS}, I_D = 15.5\ \text{mA}$	Fig. 11
			1.9		V	$V_{DS} = V_{GS}, I_D = 15.5\ \text{mA}, T_J = 175^\circ\text{C}$	
I_{DSS}	Zero Gate Voltage Drain Current		1	50	μA	$V_{DS} = 650\ \text{V}, V_{GS} = 0\ \text{V}$	
I_{GSS}	Gate-Source Leakage Current		10	250	nA	$V_{GS} = 15\ \text{V}, V_{DS} = 0\ \text{V}$	
$R_{DS(on)}$	Drain-Source On-State Resistance	10.5	15	21	m Ω	$V_{GS} = 15\ \text{V}, I_D = 55.8\ \text{A}$	Fig. 4, 5, 6
			20			$V_{GS} = 15\ \text{V}, I_D = 55.8\ \text{A}, T_J = 175^\circ\text{C}$	
g_{fs}	Transconductance		42		S	$V_{DS} = 20\ \text{V}, I_{DS} = 55.8\ \text{A}$	Fig. 7
			40			$V_{DS} = 20\ \text{V}, I_{DS} = 55.8\ \text{A}, T_J = 175^\circ\text{C}$	
C_{iss}	Input Capacitance		5011		pF	$V_{GS} = 0\ \text{V}, V_{DS} = 400\ \text{V}$ $f = 100\ \text{KHz}$ $V_{AC} = 25\ \text{mV}$	Fig. 17, 18
C_{oss}	Output Capacitance		289				
C_{rss}	Reverse Transfer Capacitance		31				
$C_{o(er)}$	Effective Output Capacitance (Energy Related)		357				Note: 3
$C_{o(tr)}$	Effective Output Capacitance (Time Related)		516				Note: 3
E_{oss}	C_{oss} Stored Energy		29				μJ
E_{ON}	Turn-On Switching Energy (Body Diode)		1500		μJ	$V_{DS} = 400\ \text{V}, V_{GS} = -4\ \text{V}/15\ \text{V}, I_D = 55.8\ \text{A},$ $R_{G(ext)} = 5\ \Omega, L = 57.6\ \mu\text{H}, T_J = 175^\circ\text{C}$ FWD = Internal Body Diode of MOSFET	Fig. 25
E_{OFF}	Turn Off Switching Energy (Body Diode)		700				
E_{ON}	Turn-On Switching Energy (External Diode)		1200		μJ	$V_{DS} = 400\ \text{V}, V_{GS} = -4\ \text{V}/15\ \text{V}, I_D = 55.8\ \text{A},$ $R_{G(ext)} = 5\ \Omega, L = 57.6\ \mu\text{H}, T_J = 175^\circ\text{C}$ FWD = External SiC DIODE	Fig. 25
E_{OFF}	Turn Off Switching Energy (External Diode)		1000				
$t_{d(on)}$	Turn-On Delay Time		22		ns	$V_{DD} = 400\ \text{V}, V_{GS} = -4\ \text{V}/15\ \text{V}$ $I_D = 55.8\ \text{A}, R_{G(ext)} = 5\ \Omega, L = 57.6\ \mu\text{H}$ Timing relative to V_{DS} Inductive load	Fig. 26
t_r	Rise Time		125				
$t_{d(off)}$	Turn-Off Delay Time		58				
t_f	Fall Time		25				
$R_{G(int)}$	Internal Gate Resistance		1.5		Ω	$f = 1\ \text{MHz}, V_{AC} = 25\ \text{mV}$	
Q_{gs}	Gate to Source Charge		54		nC	$V_{DS} = 400\ \text{V}, V_{GS} = -4\ \text{V}/15\ \text{V}$ $I_D = 55.8\ \text{A}$ Per IEC60747-8-4 pg 21	Fig. 12
Q_{gd}	Gate to Drain Charge		62				
Q_g	Total Gate Charge		188				

Note (3): $C_{o(er)}$, a lumped capacitance that gives same stored energy as C_{oss} while V_{ds} is rising from 0 to 400V

$C_{o(tr)}$, a lumped capacitance that gives same charging time as C_{oss} while V_{ds} is rising from 0 to 400V

Reverse Diode Characteristics ($T_c = 25^\circ\text{C}$ unless otherwise specified)

Symbol	Parameter	Typ.	Max.	Unit	Test Conditions	Note
V_{SD}	Diode Forward Voltage	4.7		V	$V_{GS} = -4\text{ V}, I_{SD} = 27.9\text{ A}, T_J = 25^\circ\text{C}$	Fig. 8, 9, 10
		4.2		V	$V_{GS} = -4\text{ V}, I_{SD} = 27.9\text{ A}, T_J = 175^\circ\text{C}$	
I_S	Continuous Diode Forward Current		79	A	$V_{GS} = -4\text{ V}, T_c = 25^\circ\text{C}$	
$I_{S, pulse}$	Diode pulse Current		418	A	$V_{GS} = -4\text{ V}$, pulse width t_p limited by T_{jmax}	
t_{rr}	Reverse Recovery time	85		ns	$V_{GS} = -4\text{ V}, I_{SD} = 55.8\text{ A}, V_R = 400\text{ V}$ $dif/dt = 1500\text{ A}/\mu\text{s}, T_J = 175^\circ\text{C}$	
Q_{rr}	Reverse Recovery Charge	667		nC		
I_{rrm}	Peak Reverse Recovery Current	17		A		
t_{rr}	Reverse Recovery time	74		ns	$V_{GS} = -4\text{ V}, I_{SD} = 55.8\text{ A}, V_R = 400\text{ V}$ $dif/dt = 1000\text{ A}/\mu\text{s}, T_J = 175^\circ\text{C}$	
Q_{rr}	Reverse Recovery Charge	562		nC		
I_{rrm}	Peak Reverse Recovery Current	14		A		

Thermal Characteristics

Symbol	Parameter	Typ.	Unit	Test Conditions	Note
$R_{\theta JC}$	Thermal Resistance from Junction to Case	0.35	$^\circ\text{C}/\text{W}$		Fig. 21
$R_{\theta JA}$	Thermal Resistance From Junction to Ambient	40			



Typical Performance

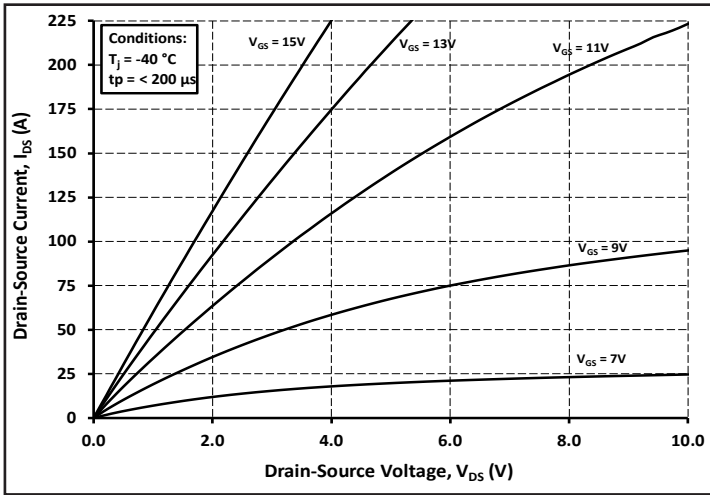

Figure 1. Output Characteristics $T_j = -40\text{ }^\circ\text{C}$

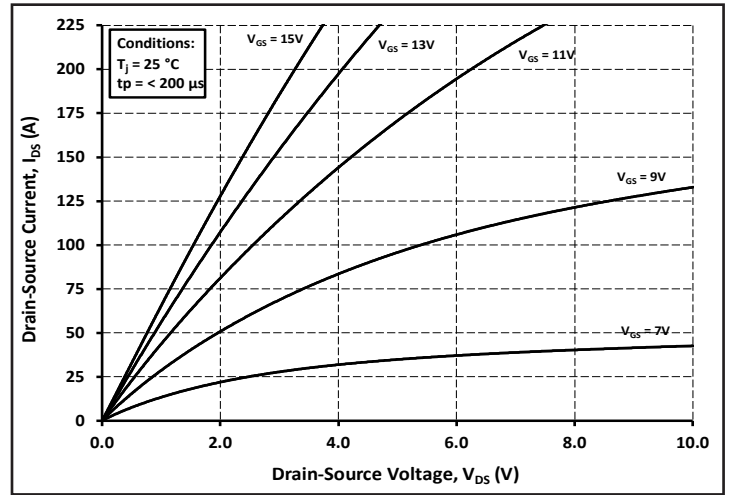

Figure 2. Output Characteristics $T_j = 25\text{ }^\circ\text{C}$

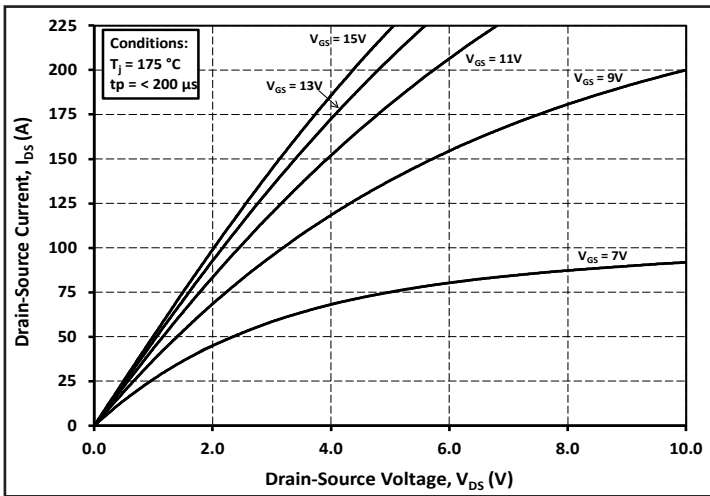

Figure 3. Output Characteristics $T_j = 175\text{ }^\circ\text{C}$

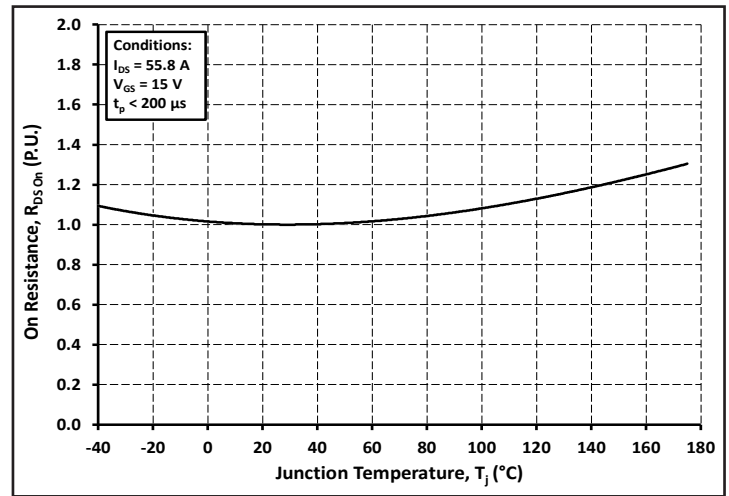

Figure 4. Normalized On-Resistance vs. Temperature

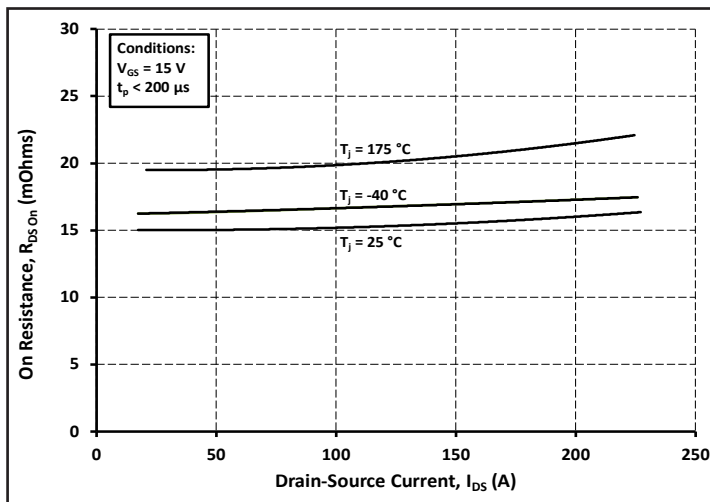

Figure 5. On-Resistance vs. Drain Current For Various Temperatures

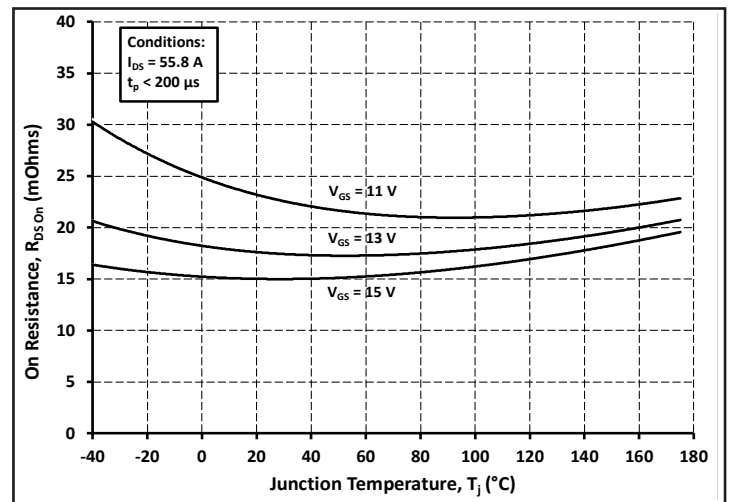

Figure 6. On-Resistance vs. Temperature For Various Gate Voltage



Typical Performance

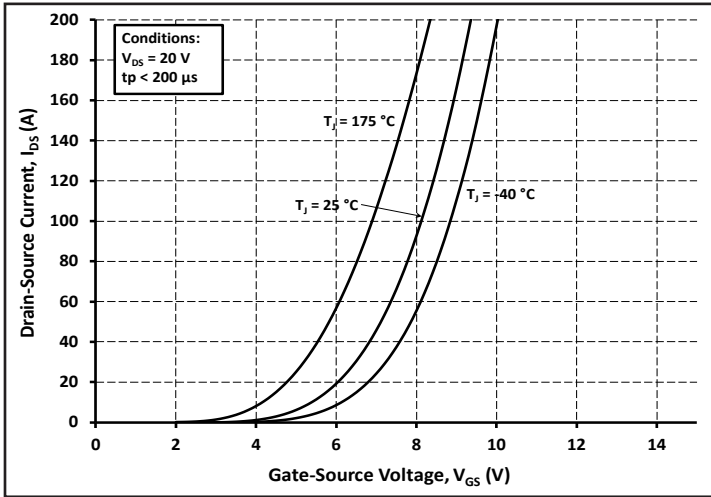

Figure 7. Transfer Characteristic for Various Junction Temperatures

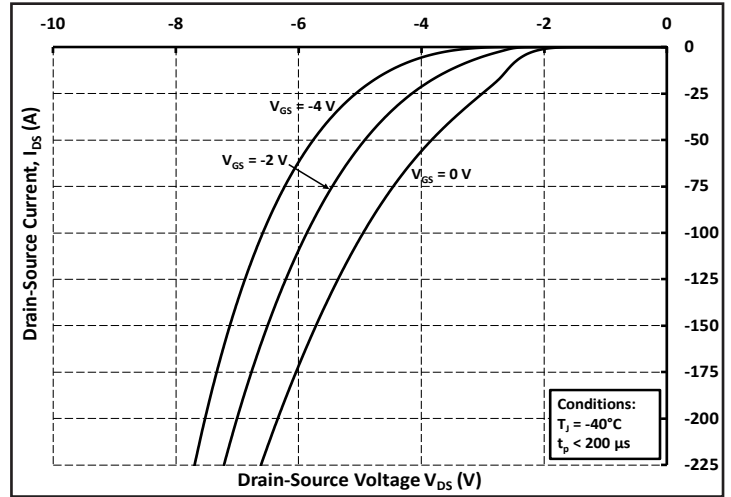

Figure 8. Body Diode Characteristic at -40 °C

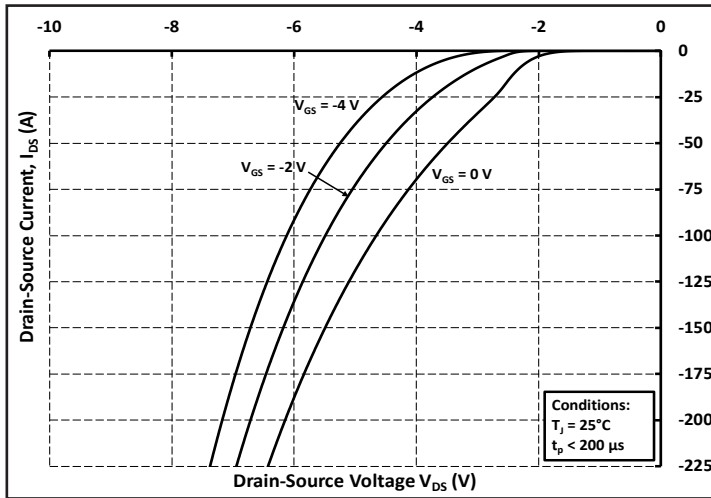

Figure 9. Body Diode Characteristic at 25 °C

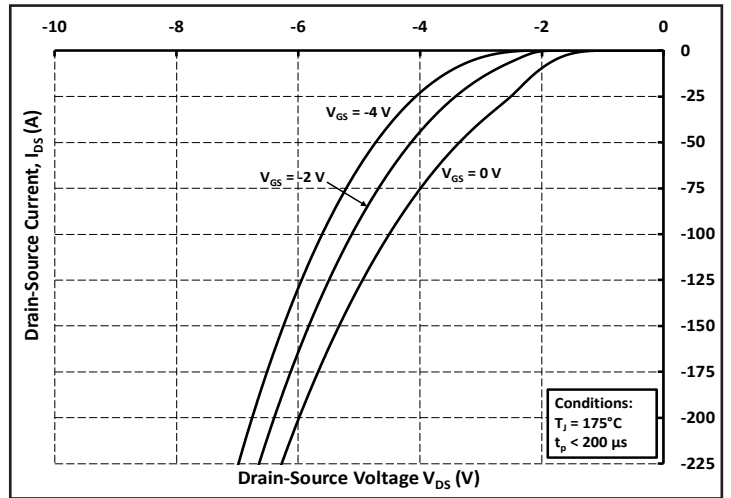

Figure 10. Body Diode Characteristic at 175 °C

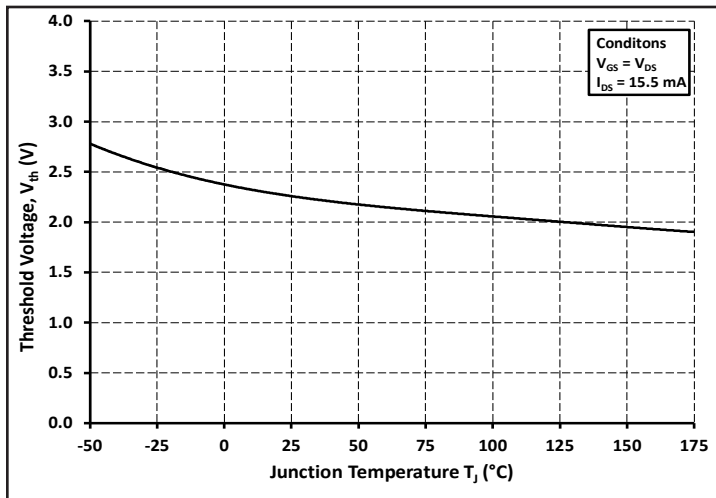

Figure 11. Threshold Voltage vs. Temperature

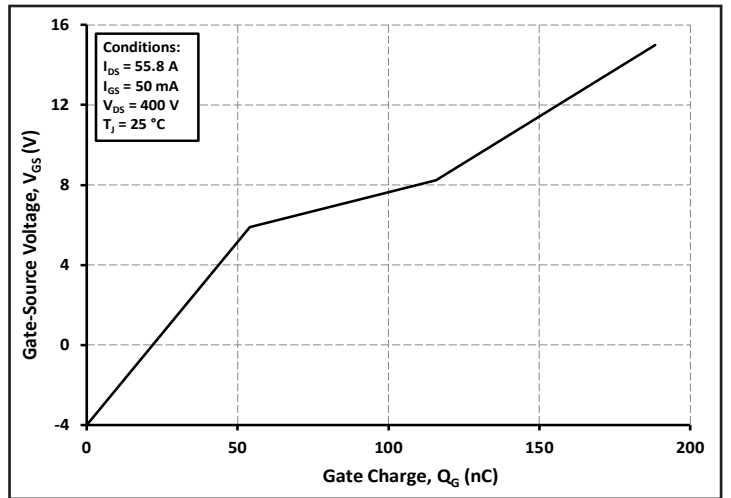

Figure 12. Gate Charge Characteristics



Typical Performance

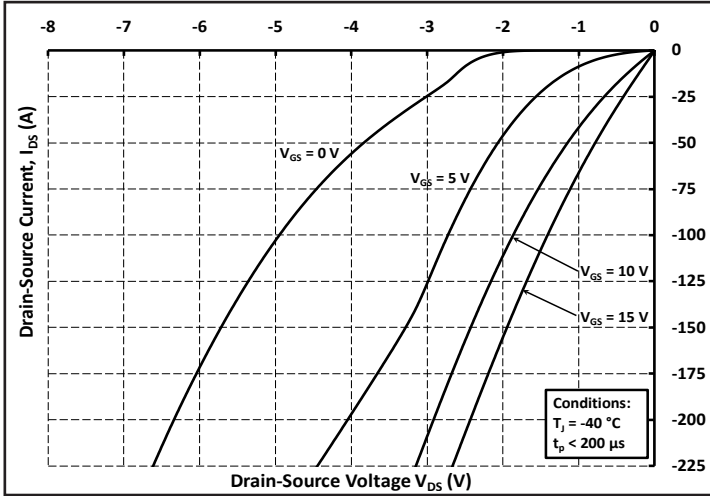

Figure 13. 3rd Quadrant Characteristic at -40 °C

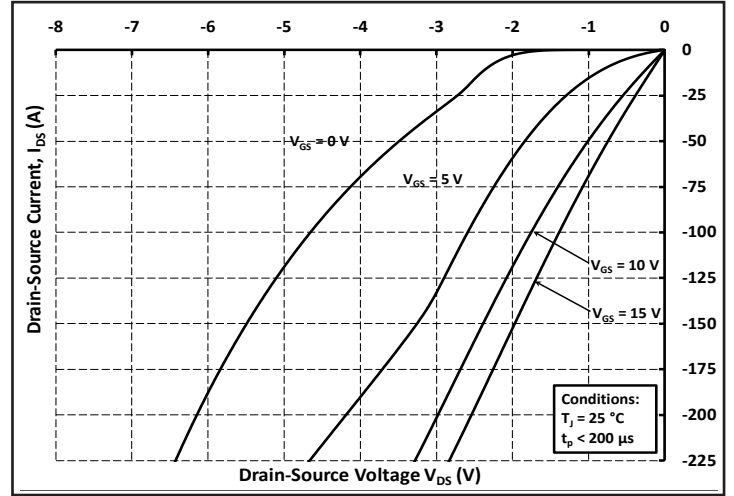

Figure 14. 3rd Quadrant Characteristic at 25 °C

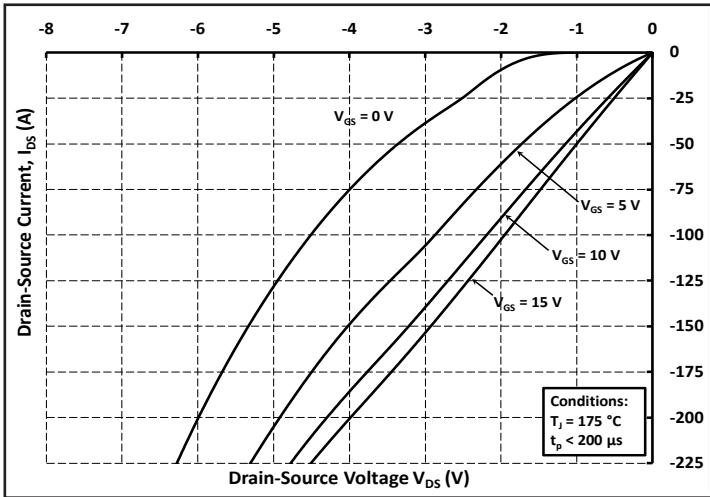

Figure 15. 3rd Quadrant Characteristic at 175 °C

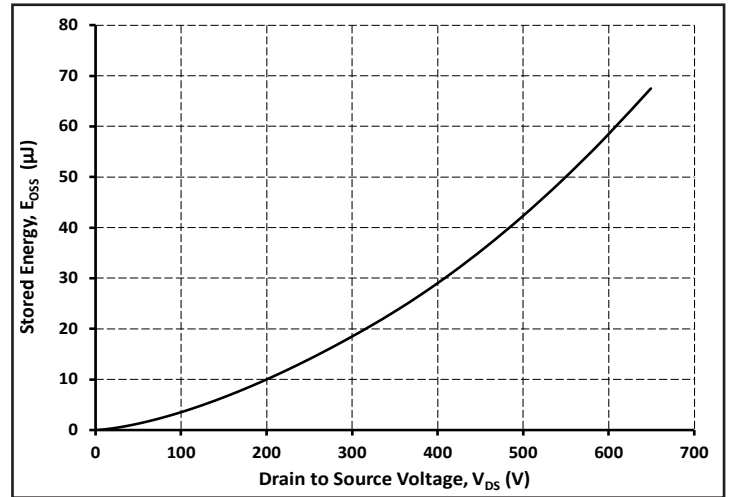

Figure 16. Output Capacitor Stored Energy

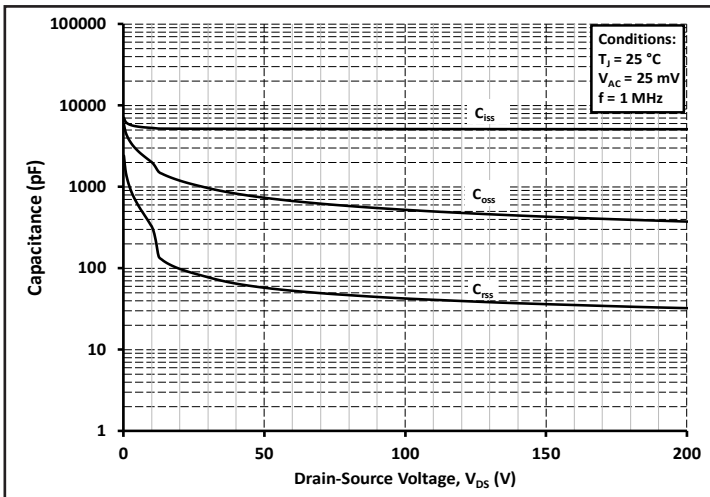

Figure 17. Capacitances vs. Drain-Source Voltage (0 - 200V)

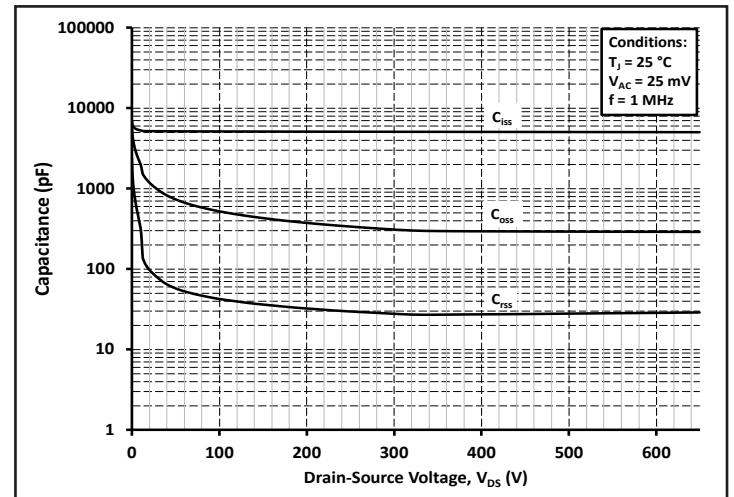

Figure 18. Capacitances vs. Drain-Source Voltage (0 - 650V)



Typical Performance

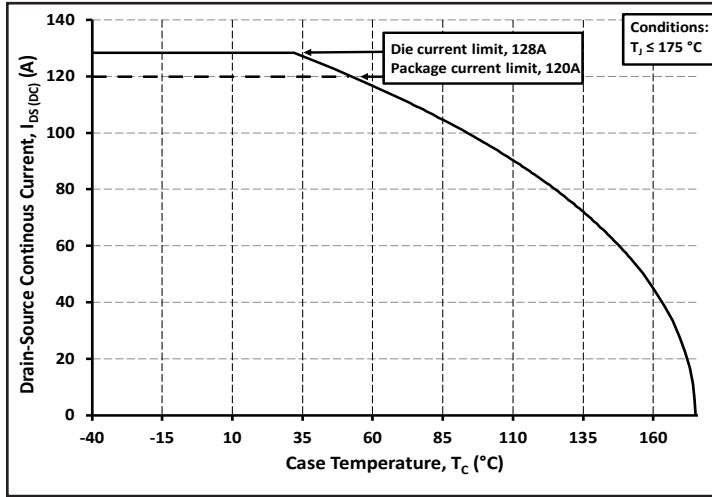

Figure 19. Continuous Drain Current Derating vs. Case Temperature

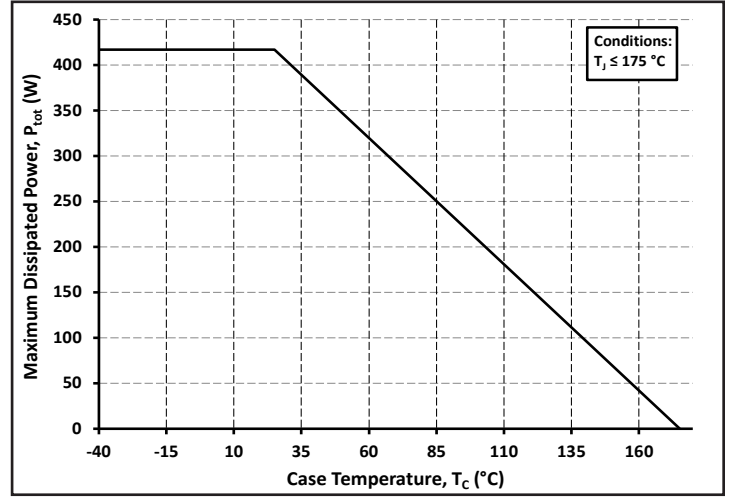

Figure 20. Maximum Power Dissipation Derating vs. Case Temperature

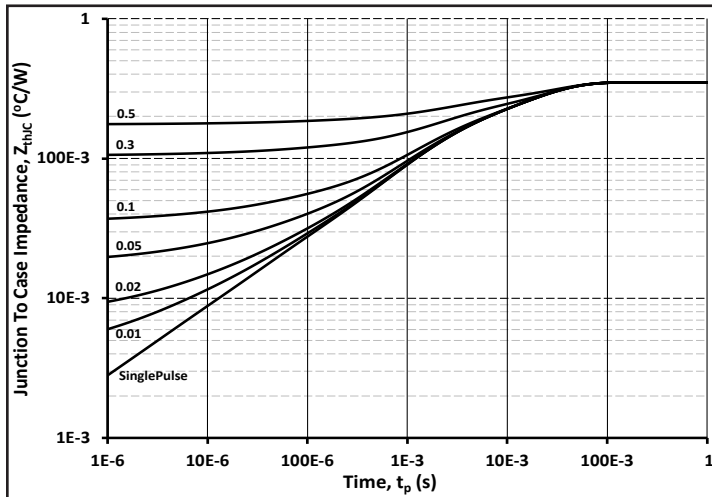

Figure 21. Transient Thermal Impedance (Junction - Case)

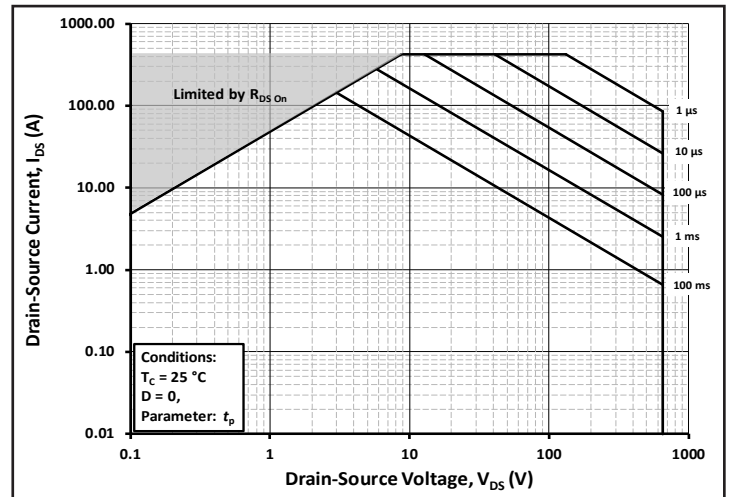

Figure 22. Safe Operating Area

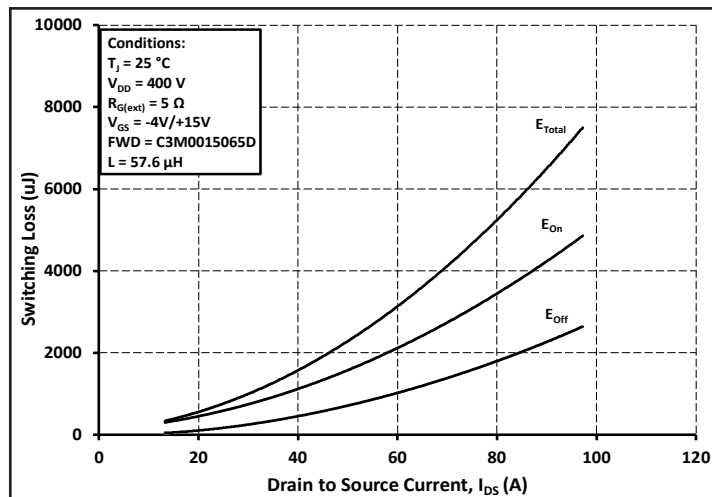

Figure 23. Clamped Inductive Switching Energy vs. Drain Current ($V_{DD} = 400V$)

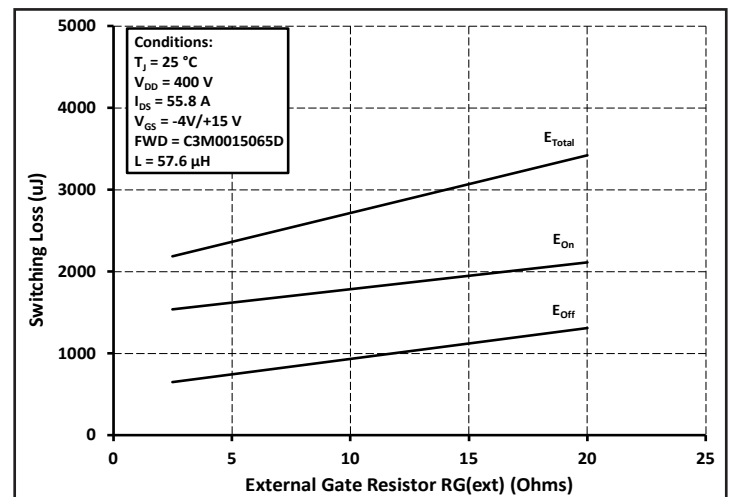

Figure 24. Clamped Inductive Switching Energy vs. $R_{G(ext)}$



Typical Performance

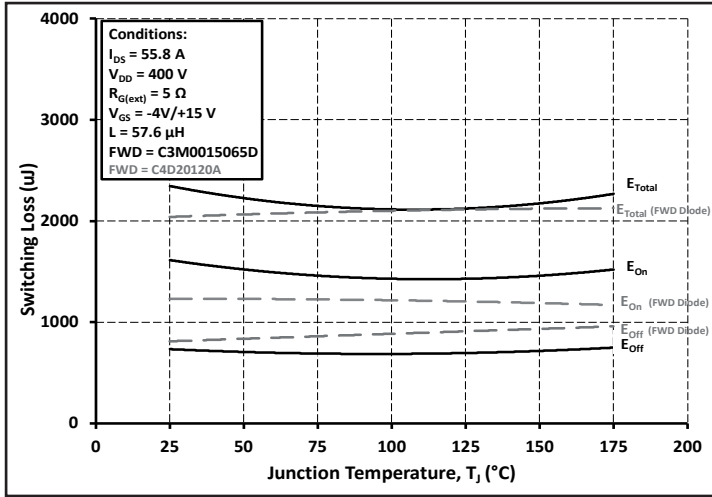

Figure 25. Clamped Inductive Switching Energy vs. Temperature

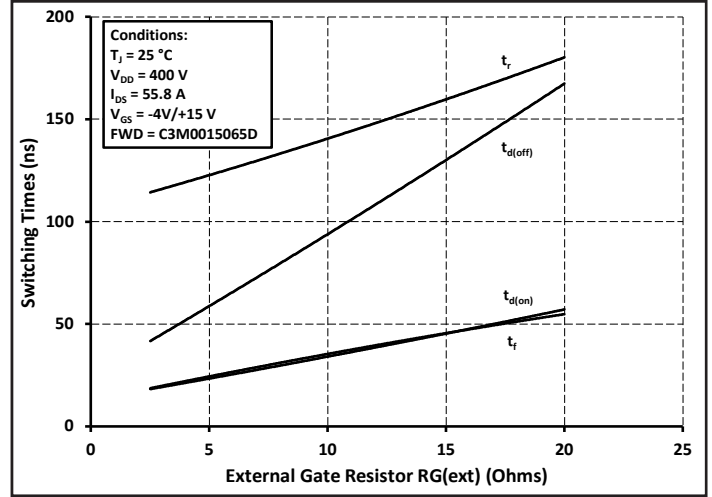

Figure 26. Switching Times vs. $R_{G(ext)}$



Test Circuit Schematic

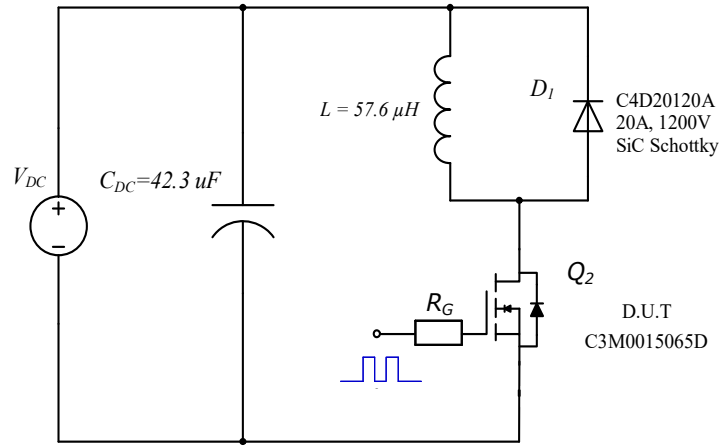

Figure 27. Clamped Inductive Switching Waveform Test Circuit

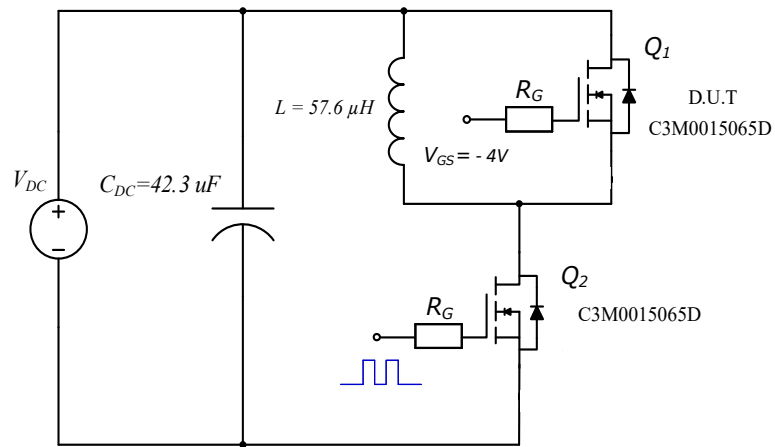
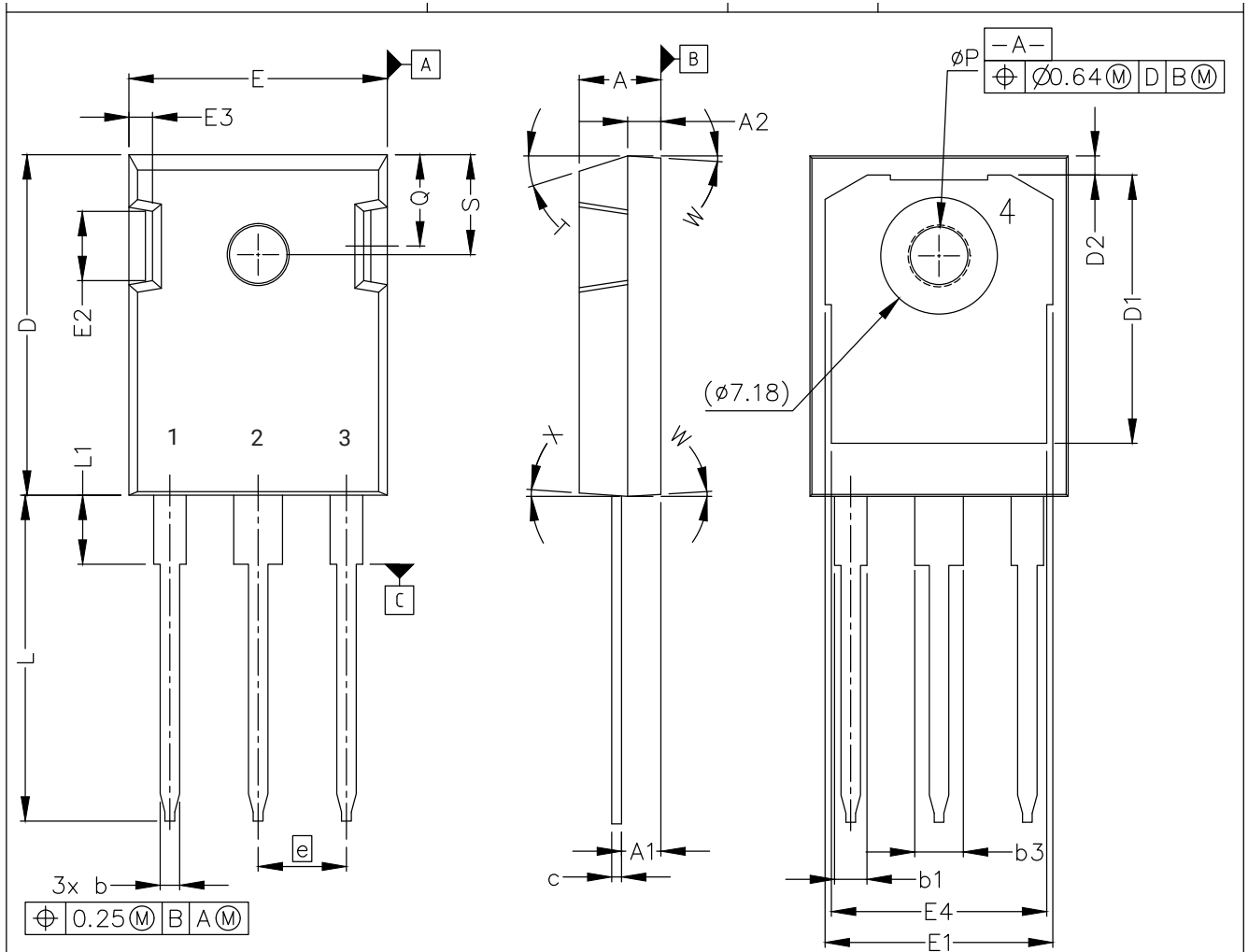

Figure 28. Body Diode Recovery Test Circuit

Package Dimensions

Package TO-247-3



NOTE ;

1. ALL METAL SURFACES: TIN PLATED, EXCEPT AREA OF CUT
2. DIMENSIONING & TOLERANCEING CONFIRM TO ASME Y14.5M-1994.
3. ALL DIMENSIONS ARE IN MILLIMETERS. ANGLES ARE IN DEGREES.
4. THIS DRAWING WILL MEET ALL DIMENSIONS REQUIREMENT OF JEDEC outlines TO-247 AD.
5. DIMENSION DO NOT INCLUDE BURR OR MOLD FLASH.

- 1 - GATE
- 2 - DRAIN (COLLECTOR)
- 3 - SOURCE (EMITTER)
- 4 - DRAIN (COLLECTOR)



Package Dimensions

Package TO-247-3

SYM	MILLIMETERS		INCHES	
	MIN	MAX	MIN	MAX
A	4.83	5.21	.190	.205
A1	2.29	2.54	.090	.100
A2	1.91	2.16	.075	.085
b	1.07	1.33	.042	.052
b1	1.91	2.41	.075	.095
b3	2.87	3.38	.113	.133
c	0.55	0.68	.022	.027
D	20.80	21.10	.819	.831
D1	16.25	17.65	.640	.695
D2	0.95	1.25	.037	.049
E	15.75	16.13	.620	.635
E1	13.10	14.15	.516	.557
E2	3.68	5.10	.145	.201
E3	1.00	1.90	.039	.075
E4	12.38	13.43	.487	.529
e	5.44 BSC		.214 BSC	
N	3		3	
L	19.81	20.32	.780	.800
L1	4.10	4.40	.161	.173
φP	3.51	3.65	.138	.144
Q	5.49	6.00	.216	.236
S	6.04	6.30	.238	.248
T	17.5° REF.			
W	3.5° REF.			
X	4° REF.			

Recommended Solder Pad Layout

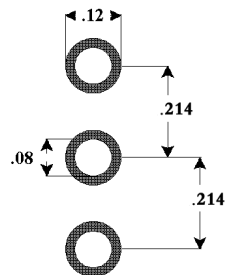

TO-247-3



Notes

This document and the information contained herein are subject to change without notice. Any such change shall be evidenced by the publication of an updated version of this document by Cree. No communication from any employee or agent of Cree or any third party shall effect an amendment or modification of this document. No responsibility is assumed by Cree for any infringement of patents or other rights of third parties which may result from use of the information contained herein. No license is granted by implication or otherwise under any patent or patent rights of Cree.

Notwithstanding any application-specific information, guidance, assistance, or support that Cree may provide, the buyer of this product is solely responsible for determining the suitability of this product for the buyer's purposes, including without limitation for use in the applications identified in the next bullet point, and for the compliance of the buyers' products, including those that incorporate this product, with all applicable legal, regulatory, and safety-related requirements.

This product has not been designed or tested for use in, and is not intended for use in, applications in which failure of the product would reasonably be expected to cause death, personal injury, or property damage, including but not limited to equipment implanted into the human body, life-support machines, cardiac defibrillators, and similar emergency medical equipment, aircraft navigation, communication, and control systems, aircraft power and propulsion systems, air traffic control systems, and equipment used in the planning, construction, maintenance, or operation of nuclear facilities.

RoHS Compliance

The levels of RoHS restricted materials in this product are below the maximum concentration values (also referred to as the threshold limits) permitted for such substances, or are used in an exempted application, in accordance with EU Directive 2011/65/EC (RoHS2), as implemented January 2, 2013. RoHS Declarations for this product can be obtained from your Cree representative or from the Product Documentation sections of www.cree.com.

REACH Compliance

REACH substances of high concern (SVHCs) information is available for this product. Since the European Chemical Agency (ECHA) has published notice of their intent to frequently revise the SVHC listing for the foreseeable future, please contact your Cree representative to ensure you get the most up-to-date REACH SVHC Declaration. REACH banned substance information (REACH Article 67) is also available upon request.

For more information please contact:
4600 Silicon Drive Durham, NC 27703 USA
Tel: +1.919.313.5300
www.wolfspeed.com/power