

## Evaluating the **ADAU1781** SigmaDSP using the **EVAL-ADAU1781Z**

### EVAL-ADAU1781Z PACKAGE CONTENTS

- EVAL-ADAU1781Z evaluation board
- EVAL-ADUSB2EBZ (USBi) communications adapter
- USB cable with Mini-B plug
- Evaluation board/software quick start guide

### DOCUMENTS NEEDED

- ADAU1781 data sheet
- INMP401 data sheet
- AN-1006 Application Note, *Using the EVAL-ADUSB2EBZ*

### GENERAL DESCRIPTION

This user guide explains the design and setup of the **EVAL-ADAU1781Z** SigmaDSP® evaluation board.

This evaluation board provides full access to all analog and digital I/Os on the **ADAU1781**. The SigmaDSP is controlled by Analog Devices, Inc., SigmaStudio™ software, which interfaces to the board via a USB connection. This evaluation board can be powered either over the USB bus or by a single 3.8 V to 6 V supply, which is regulated to the voltages required on the board. The PC board is a 4-layer design, with a single ground plane and a single power plane on the inner layers. The board contains on-board microphones and speaker, and connectors for external microphones and speaker. The master clock can be provided externally or by the on-board 12.288 MHz active oscillator.

### EVALUATION BOARD TOP SIDE AND BOTTOM SIDE

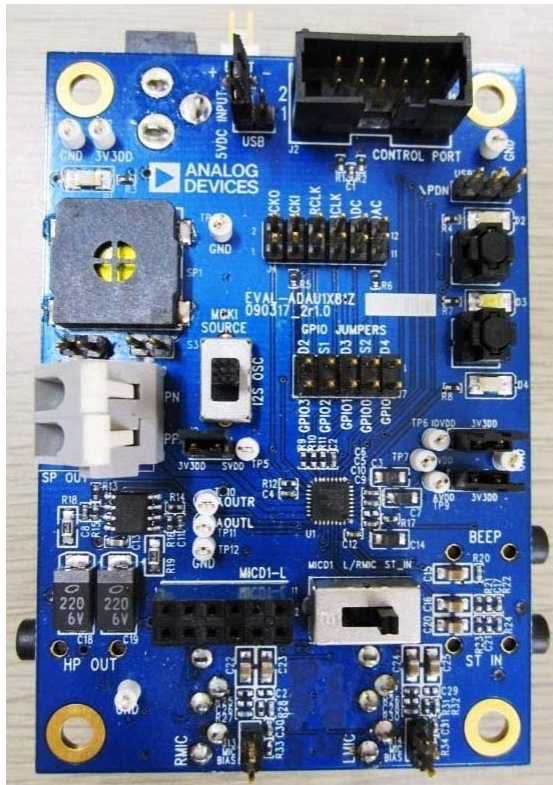

Figure 1. Evaluation Board Top Side

08314-001

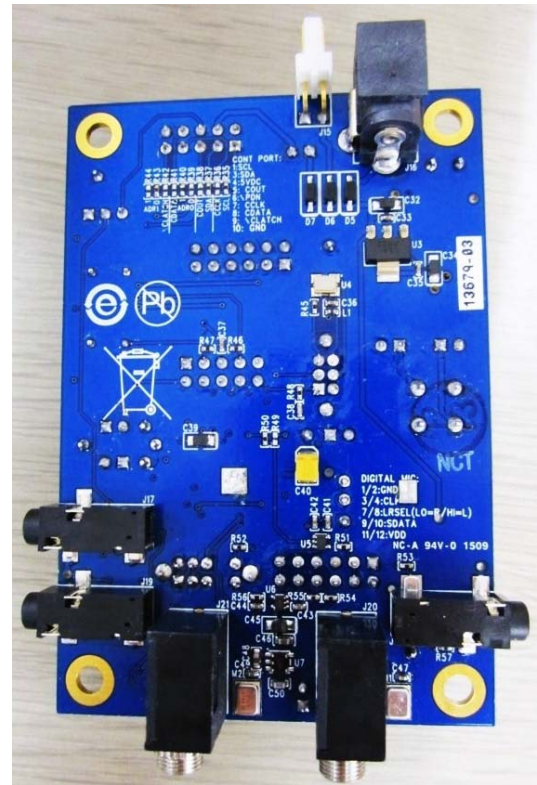

Figure 2. Evaluation Board Bottom Side

08314-002

**TABLE OF CONTENTS**

EVAL-ADAU1781Z Package Contents.....	1	Creating a Basic Signal Flow.....	7
Documents Needed.....	1	Downloading the Program to the DSP.....	10
General Description.....	1	Using the Evaluation Board.....	11
Evaluation Board Top Side and Bottom Side.....	1	Power.....	11
Revision History.....	2	Master Clock.....	11
Evaluation Board Block Diagrams.....	3	Inputs and Outputs.....	11
Setting Up the Evaluation Board.....	5	GPIO.....	11
SigmaStudio Software Installation.....	5	Serial Audio Interface.....	11
Installing the USBi Drivers.....	5	Communications Header.....	11
Default Switch and Jumper Settings.....	5	Power-Down.....	11
Powering Up the Board.....	6	Evaluation Board Schematics and Artwork.....	12
Connecting the Audio Cables.....	6	Ordering Information.....	21
Setting Up Communications in SigmaStudio.....	6	Bill of Materials.....	21
Configuring the Registers.....	6	Related Links.....	22

**REVISION HISTORY**

**1/15—Rev. 0 to Rev. A**

Changed ADMP401 to INMP401.....	Throughout
Deleted Installing the SigmaStudio Software Section.....	5
Added SigmaStudio Software Installation Section.....	5

**7/10—Revision 0: Initial Version**

# EVALUATION BOARD BLOCK DIAGRAMS

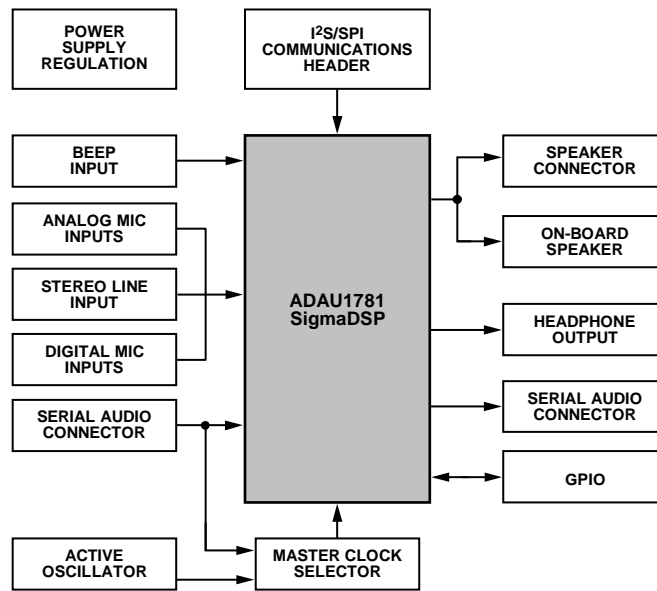

Figure 3. Functional Block Diagram

08314-003

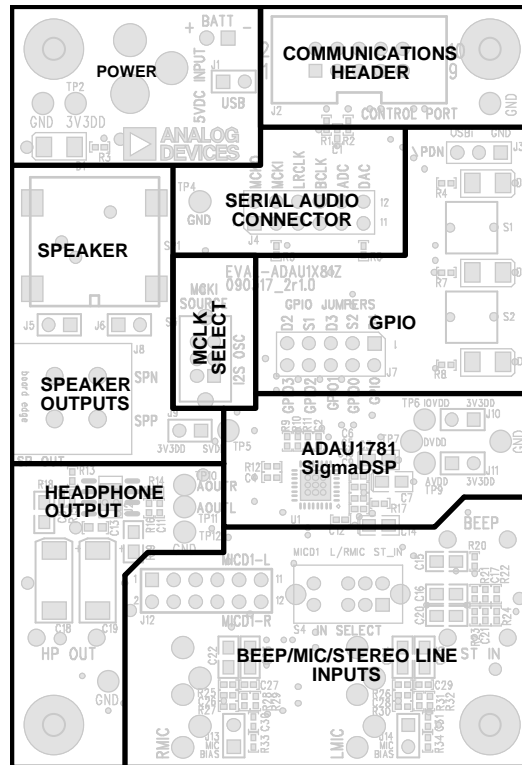

Figure 4. Board Layout Block Diagram

08314-004

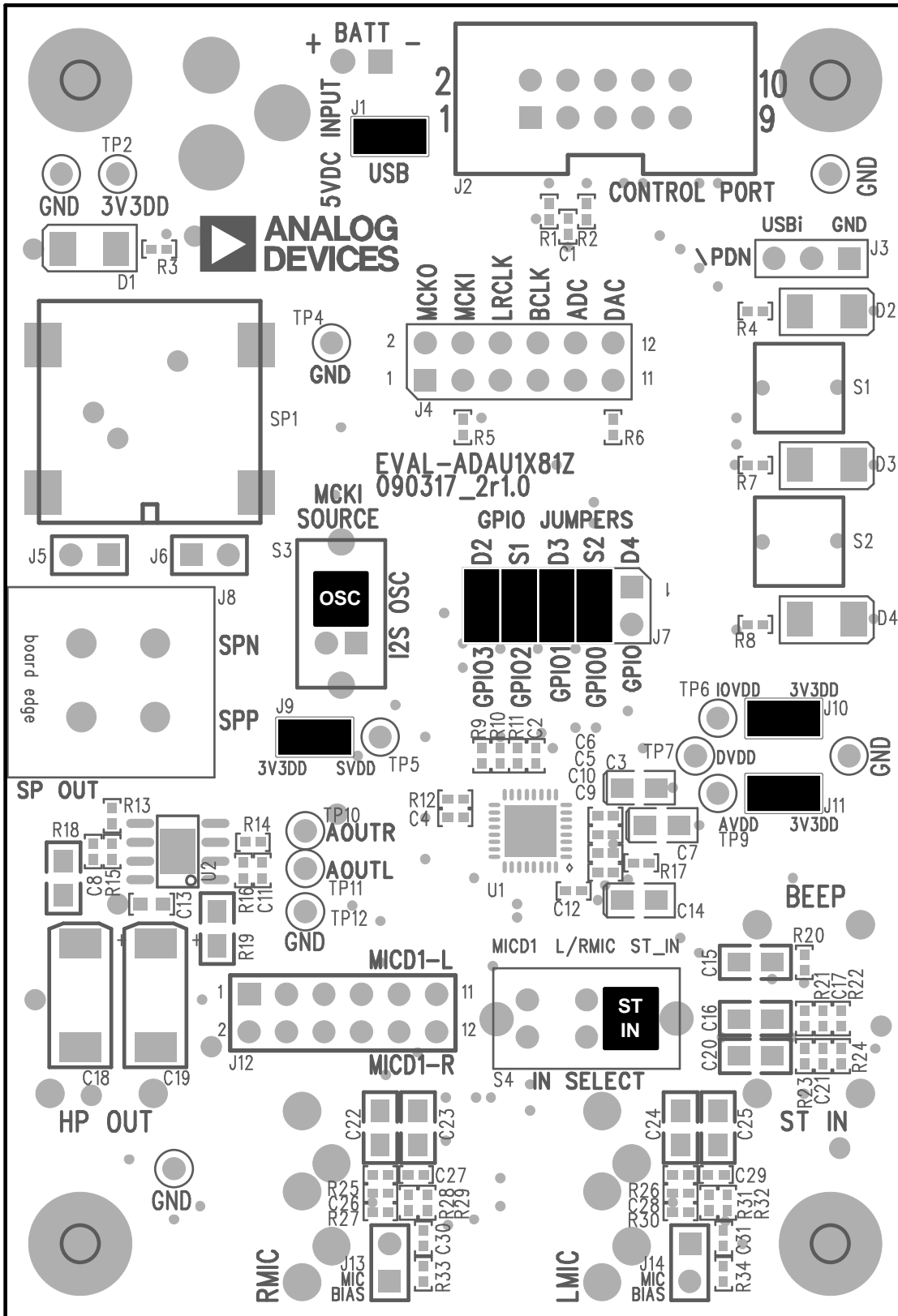

Figure 5. Default Jumper and Switch Settings (A Solid Black Rectangle Indicates a Switch or Jumper Position)

08314-005

## SETTING UP THE EVALUATION BOARD

### SigmaStudio SOFTWARE INSTALLATION

SigmaStudio must be installed to use the EVAL-ADAU1781Z. To download and install the SigmaStudio software, follow these steps:

1. Create or log into your myAnalog account at [www.analog.com](http://www.analog.com).
2. Download the SigmaStudio software from [www.analog.com/SigmaStudioDownload](http://www.analog.com/SigmaStudioDownload).
3. Install SigmaStudio by double-clicking **ADI\_SigmaStudioRel-<version>.exe** and following the prompts. A PC restart is not required.
4. Consult the [SigmaDSP Processors and SigmaStudio Development Tool](#) page at [EngineerZone](#) for answers to any questions.

### INSTALLING THE USBi DRIVERS

SigmaStudio must be installed to use the USBi. When SigmaStudio has been properly installed, connect the USBi to an available USB port with the included USB cable. At this point, Windows® XP recognizes the device and prompts the user to install drivers (see Figure 6).



Figure 6. Found New Hardware Notification

Select **Install from a list or specific location (Advanced)** and click **Next >** (see Figure 7).



Figure 7. Found New Hardware Wizard—Installation

Select **Search for the best driver in these locations**, select **Include this location in the search**, and click **Browse** to find the SigmaStudio 3.0\USB drivers directory (see Figure 8).

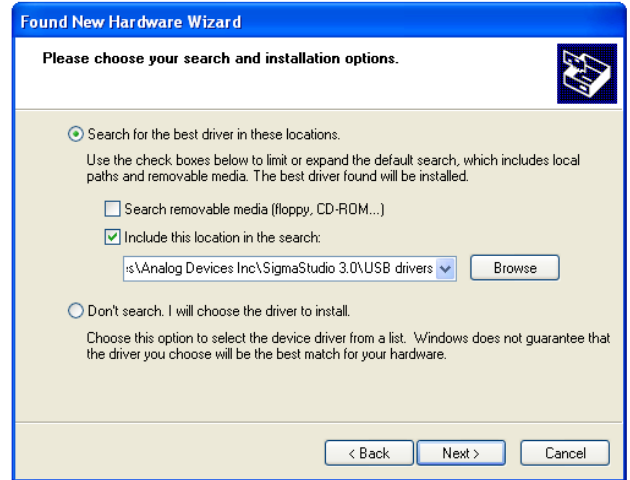

Figure 8. Windows Found New Hardware Wizard—Search and Installation Options

When the warning about Windows Logo testing appears, click **Continue Anyway** (see Figure 9).



Figure 9. Windows Logo Testing Warning

The USBi drivers are now installed. Leave the USBi connected to the PC.

### DEFAULT SWITCH AND JUMPER SETTINGS

By default, the evaluation board is configured for single-ended stereo analog input and headphone output.

The J1, J10, J11, J13, and J14 jumpers must be connected. The GPIO jumper (J7) can be connected as desired to use GPIO circuitry.

Switch S3 (MCKI SOURCE) should be in the up (OSC) position, and Switch S4 (IN SELECT) should be in the right (ST\_IN) position.

**POWERING UP THE BOARD**

To power up the board, connect the ribbon cable of the USBi to J2 (CONTROL PORT) of the EVAL-ADAU1781Z.

**CONNECTING THE AUDIO CABLES**

Connect a stereo audio source to J19 (ST IN). Connect headphones or powered speakers to J18 (HP OUT). The labels for J18 and J19 are only visible on the bottom of the board.

**SETTING UP COMMUNICATIONS IN SIGMASTUDIO**

Start SigmaStudio by double-clicking the shortcut on the desktop.

Click **File...New Project** or press **Ctrl+N** to create a new project. The default view of the new project is called the **Hardware Configuration** tab.

To use the USBi in conjunction with SigmaStudio, first select it in the **Communication Channels** subsection of the toolbox on the left side of the **Hardware Configuration** tab, and add it to the project space by clicking and dragging it to the right (see Figure 10).

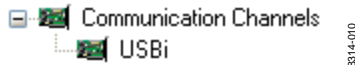

Figure 10. Adding the USBi Communication Channel

If SigmaStudio cannot detect the USBi on the USB port of the computer, the background of the **USB** label will be red (see Figure 11). This may happen when the USBi is not connected or when the drivers are incorrectly installed.

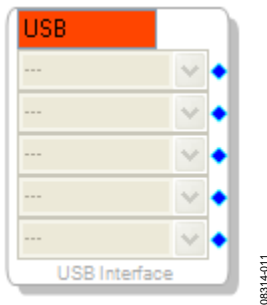

Figure 11. USBi Not Detected by SigmaStudio

If SigmaStudio detects the USBi on the USB port of the computer, the background of the **USB** label changes to orange (see Figure 12).

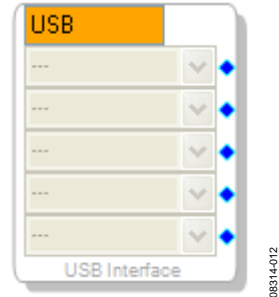

Figure 12. USBi Detected by SigmaStudio

To add an ADAU1781 to the project, select it from the **Processors (ICs / DSPs)** list and drag it to the project space (see Figure 13).

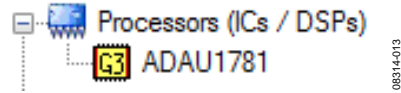

Figure 13. Adding an ADAU1781

To use the USB interface to communicate with the target IC, connect it by clicking and dragging a wire between the blue pin of the USBi and the green pin of the IC (see Figure 14). The corresponding drop-down box of the USBi automatically fills with the default mode and channel for that IC.

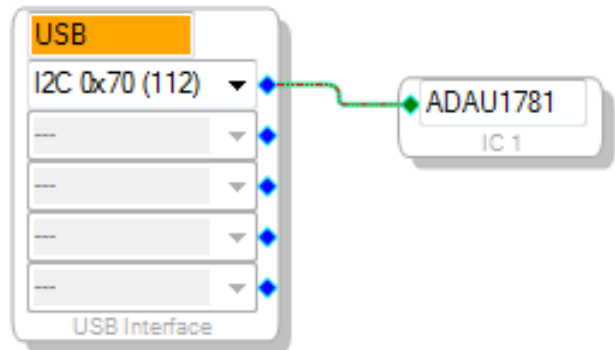

Figure 14. Connecting the USB Interface to an ADAU1781 IC

**CONFIGURING THE REGISTERS**

To access the graphical register control window, click the **IC 1 – SigmaLP2 Register Controls** tab near the bottom of the window (see Figure 15).

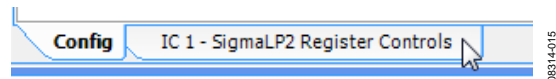

Figure 15. Register Control Tab

Within the register control view, there are several tabs at the top for easy navigation. Start with the **Codec Setup** tab (see Figure 16).

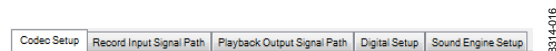

Figure 16. Codec Setup Register Tab

In the **Automatic Startup** section, click **Load Preset** (see Figure 17).



Figure 17. Load Preset Button

If the board is connected and powered and the USBi drivers are installed correctly, the **PLL Lock Bit** indicator to the left of the **Load Preset** button changes to green to indicate that it is **Locked** (see Figure 18).

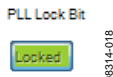

Figure 18. PLL Lock Indicator

Click the **Record Input Signal Path** tab (see Figure 19).

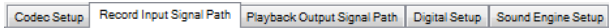

Figure 19. Record Input Signal Path

In the **Record Gain Left (PGA)** and **Record Gain Right (PGA)** sections, the **Single ended Input Enable** controls are disabled by default. Click each button once to enable the single-ended input (see Figure 20).

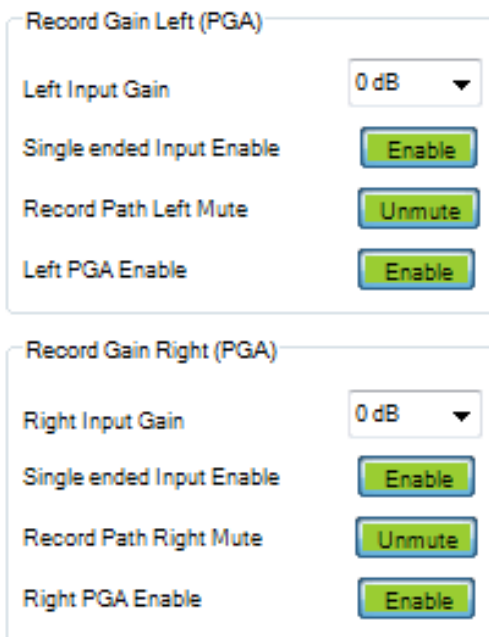

Figure 20. Record Path Controls

The rest of the register settings can remain at their default values.

### CREATING A BASIC SIGNAL FLOW

To access the **Schematic** tab, where a signal processing flow can be created, click the **Schematic** tab at the top of the screen (see Figure 21).

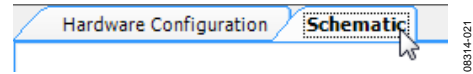

Figure 21. Schematic Tab

The left side of the schematic view includes the **Tree Toolbox**, which contains all of the algorithms that can run in the SigmaDSP. Select the **Input** cell from within the **IO > Input** folder (see Figure 22).

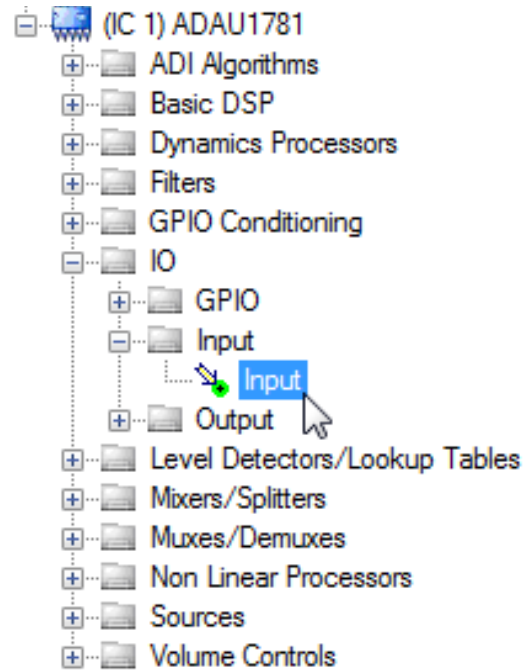

Figure 22. Input Cell Selection

Click and drag the **Input** cell into the blank schematic space to the right of the **Tree Toolbox** (see Figure 23).



Figure 23. Input Cell



Navigate to the **IO > Output** folder and select the **Output** cell (see Figure 24).

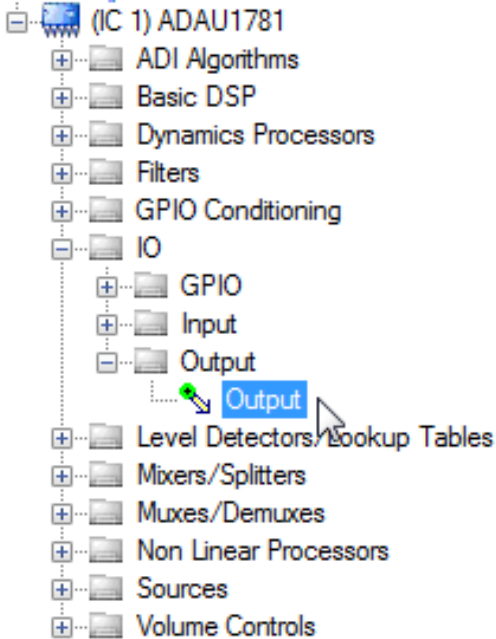

Figure 24. Output Cell Selection

Click and drag an output cell to the schematic. Do this again to create two outputs (see Figure 25).

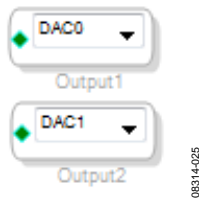

Figure 25. Output Cells

Navigate to the **Volume Controls > Adjustable Gain > Single/Multiple Controls/Clickless SW Slew** folder and select the **Growable Single Vol Ctrl** cell (see Figure 26).

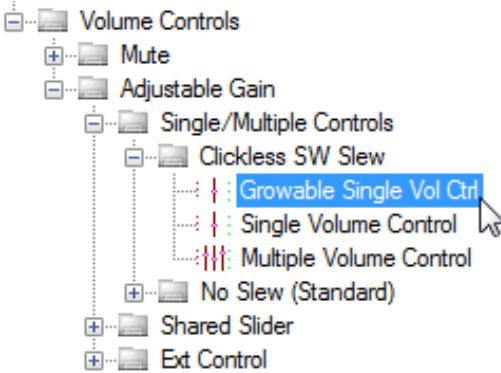

Figure 26. Volume Control Cell Selection

Click and drag this cell to the schematic (see Figure 27).

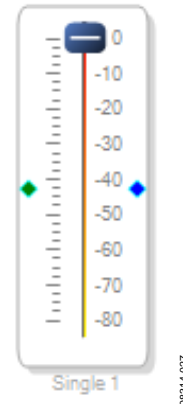

Figure 27. Volume Control Cell

By default, this cell only has one input channel and one output channel, as indicated by the green input and right output dots. To add a channel, right-click in the blank white part of the cell and select **Grow Algorithm > 1. Gain (RC slew) Growable DP > 1** from the menu (see Figure 28).

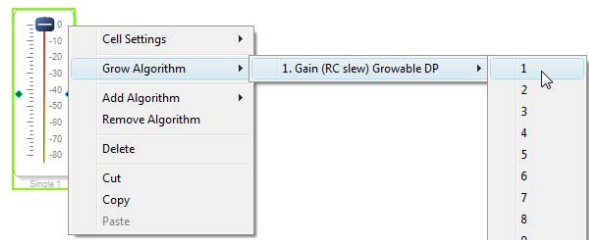

Figure 28. Growing the Volume Control

The cell should now have two inputs and two outputs (see Figure 29).

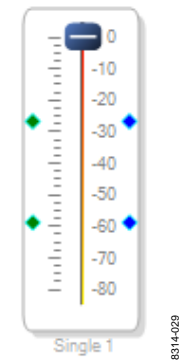

Figure 29. Stereo Volume Control Cell



Navigate to the **Filters > Second Order > Single Precision > Optimized > 2 Ch** folder and select the **Medium Size Eq cell** (see Figure 30).

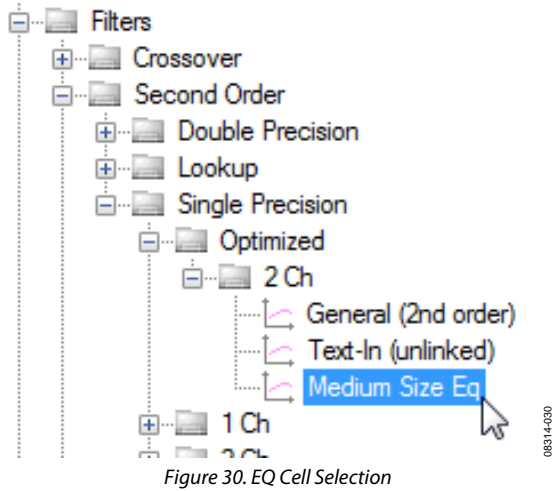

Figure 30. EQ Cell Selection

Click and drag the cell to the schematic (see Figure 31).

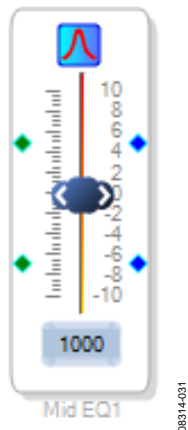

Figure 31. Single-Band Stereo EQ Cell

By default, the EQ only has one band. To increase the number of bands, right click in the blank white part of the cell and select **Grow Algorithm > 1. 2 Channel - Single Precision, Optimized > 4** to increase the EQ to five bands (see Figure 32).

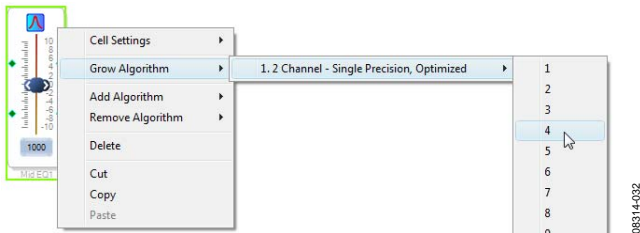

Figure 32. Growing the EQ Cell

The EQ should now have five bands (see Figure 33).



Figure 33. Five-Band Stereo EQ Cell

To change the properties of a filter, click its corresponding blue filter icon once (see Figure 34).



Figure 34. Filter Properties Button

Configure each filter as required. As an example, create a low shelf at 50 Hz, peaking filters at 200 Hz, 500 Hz, and 2000 Hz, and a high shelf at 10 kHz (see Figure 35).

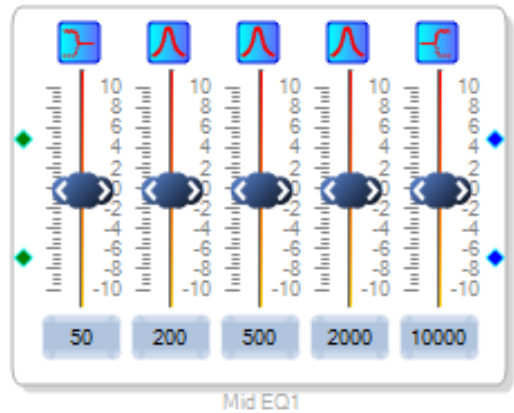

Figure 35. Configured Five-Band EQ Cell

Connect the cells together by left-clicking a blue output dot and clicking and dragging to the green output dot of the next cell. Continue until the signal flow is completed from input to output for each channel (see Figure 36).

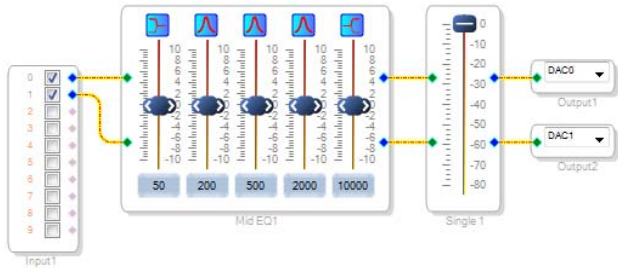

Figure 36. Completed Signal Flow

The basic signal flow is now complete with stereo I/O, a five-band equalizer, and a clickless volume control.

### DOWNLOADING THE PROGRAM TO THE DSP

To compile and download the code to the DSP, click **Link-Compile-Download** once in the main toolbar of SigmaStudio (see Figure 37). Alternately, press the F7 key.



Figure 37. Link-Compile-Download Button

The signal flow should now be running on the evaluation board, and audio should pass from input to output. The controls for filters and volume can be changed in real time by clicking and dragging them with the mouse.

## USING THE EVALUATION BOARD

### POWER

Power can be supplied via the USB bus by connecting the EVAL-ADUSB2EBZ (USBi) to Header J2, by a battery connected to J15, or by a tip-positive 3.8 V dc to 6 V dc power supply on Connector J16. In the case of power over the USB bus, connect Jumper J1. The on-board regulator generates the 3.3 V dc supply for the on-board circuitry. LED D1 lights up when power is supplied to the board. To connect the output of the regulator to the [ADAU1781](#), connect the J10 and J11 jumpers. Optionally, J9 can be connected if the speaker outputs are used.

### MASTER CLOCK

The master clock to the [ADAU1781](#) can be supplied either by an on-board active 12.288 MHz oscillator or over the serial port connectors. Setting the MCKI source selector switch to the OSC position connects the active oscillator to the master clock input pin of the [ADAU1781](#). Setting this switch to the I<sup>2</sup>S position connects the master clock input of the [ADAU1781](#) to Pin 3 on Serial Audio Interface Header J4, which is labeled MCKI.

### INPUTS AND OUTPUTS

The board has multiple audio input and output options, including digital and analog. The analog beep channel is always enabled. The input select switch, S4, chooses among the remaining audio input options: stereo line input, digital microphones, and analog microphones.

#### *Stereo Line Input*

The stereo input jack, J19, accepts a standard stereo TRS 1/8-inch mini-plug with two channels of audio.

#### *Digital Microphones*

Digital microphones can be connected to Header J12.

#### *Analog Microphones*

Two [INMP401](#) MEMS analog microphones in a single-ended configuration are mounted on the underside of the board. External analog microphones, in both differential and single-ended input configurations, can be connected to the input jacks, J20 and J21. If plugs are connected into the J20 and J21 jacks, the on-board MEMS microphones are automatically disconnected. A bias should be applied to external differential microphones by connecting the J13 and J14 jumpers.

#### *Beep Input*

The analog beep input accepts a mono TS 1/8-inch mini-plug with one channel of audio.

#### *Headphone Output*

The headphone output connects to any standard 1/8-inch mini-plug stereo headphones. The output power varies depending on the impedance of the headphones.

#### *Speaker Outputs*

To use the speaker output, SVDD Power Jumper J9 must be connected. The speaker output of the [ADAU1781](#) can drive an external speaker or an on-board speaker. In the case of an external speaker, it should be connected to the Speaker Output Connector J8 and the J5 and J6 jumpers should be disconnected. To use the on-board speaker, disconnect J8 and connect J5 and J6.

### GPIO

The GPIO jumper header J7 allows the GPIO circuitry, consisting of switches and LEDs, to be connected to the GPIO pins of the [ADAU1781](#). If the GPIO circuitry is connected, the corresponding pins cannot be used for the serial audio interface.

### SERIAL AUDIO INTERFACE

Serial audio signals in I<sup>2</sup>S or TDM format can be connected to the Serial Audio Interface Header J4. This header also includes master clock input and output connection pins.

### COMMUNICATIONS HEADER

The Communications Header J1 connects to the EVAL-ADUSB2EBZ. More information about the USBi can be found in the [AN-1006 Application Note](#).

The [ADAU1781](#) uses I<sup>2</sup>C communications protocol by default. An SPI can be used by moving several resistors on the bottom side of the board. To use SPI mode, move Resistor R35 to the R36 pads, move Resistor R37 to the R38 pads, move Resistor R39 to the R41 pads, and move Resistor R43 to the R42 pads.

### POWER-DOWN

The Power-Down Header J3, labeled \PDN on the silkscreen of the board, provides access to the power-down pin on the [ADAU1781](#). On this 3-pin header, a 2-pin jumper can be used to connect the power-down pin to either the USBi or to ground.

EVALUATION BOARD SCHEMATICS AND ARTWORK

900-14380

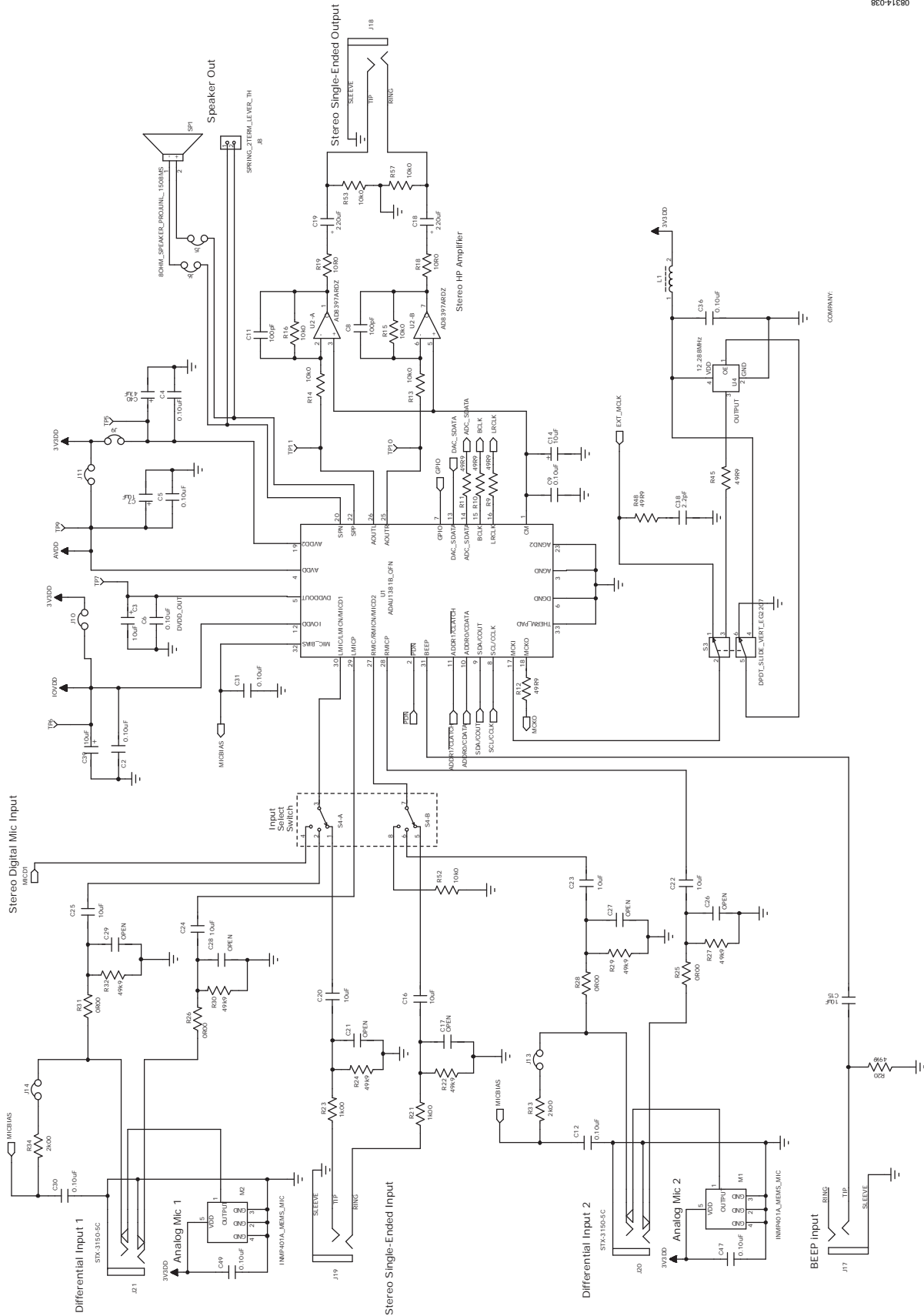
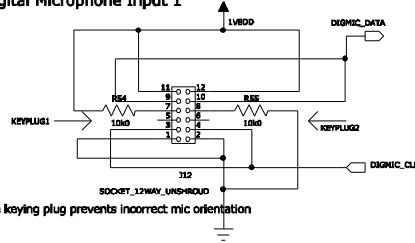

Figure 38. Evaluation Board Schematic—SigmaDSP, Analog I/O, and Master Clock Generation

Digital Microphone Input 1



Pins 7/8: LRSEL (LO=R/HI=L)

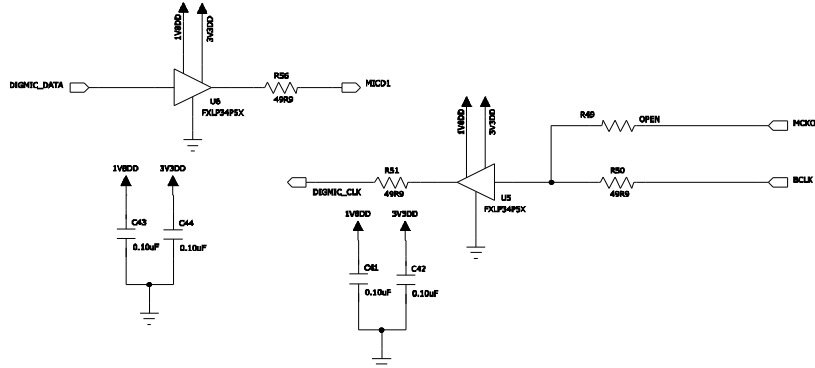

Figure 39. Evaluation Board Schematic—Digital Microphone Interface

Serial Data Interface

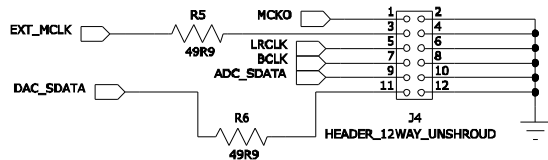

Figure 40. Evaluation Board Schematic—Serial Audio Data Interface

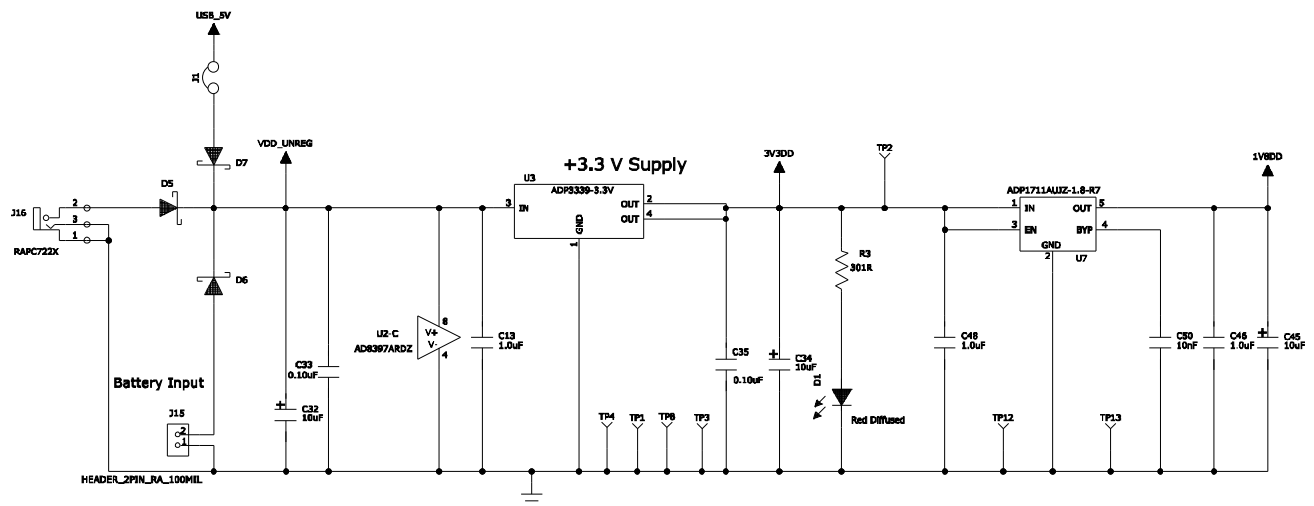

Figure 41. Evaluation Board Schematic—Power Supply

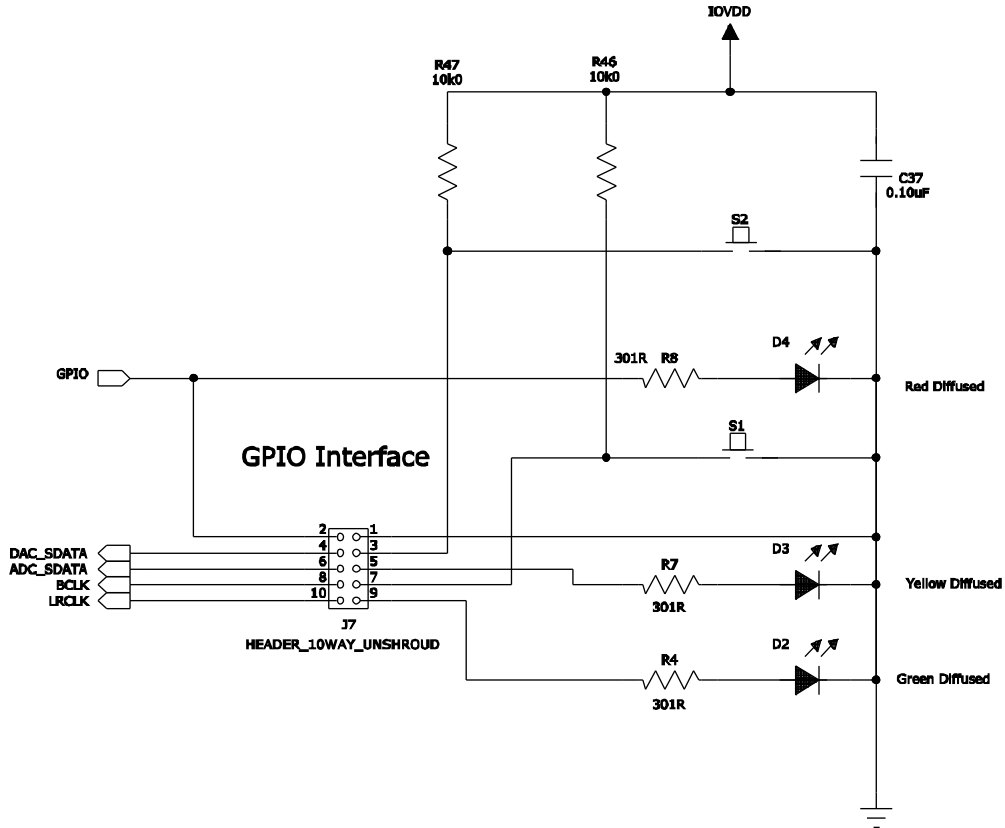

Figure 42. Evaluation Board Schematic—GPIO Interface

08314-042

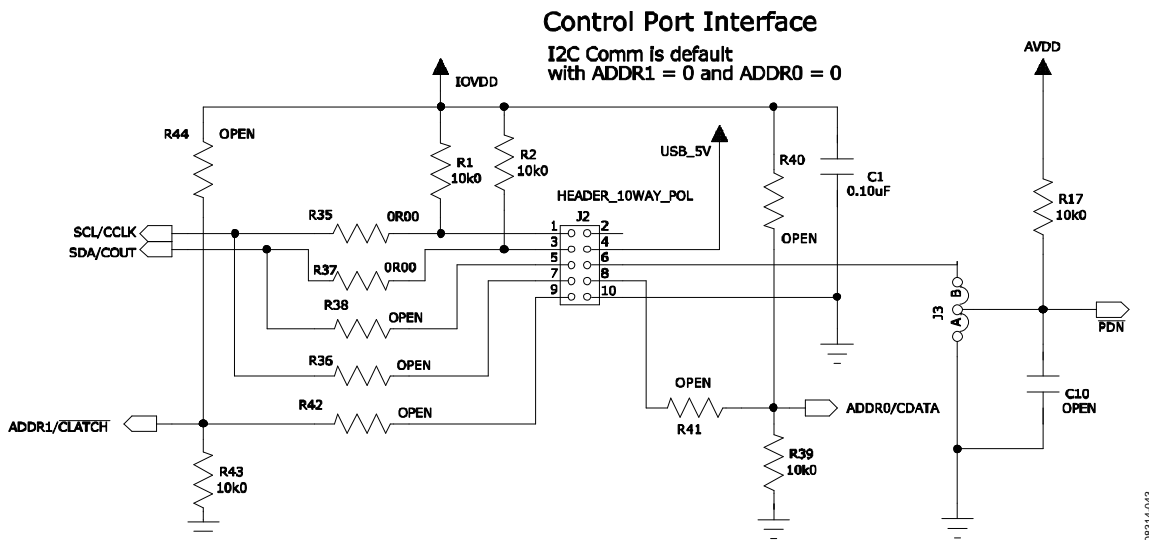
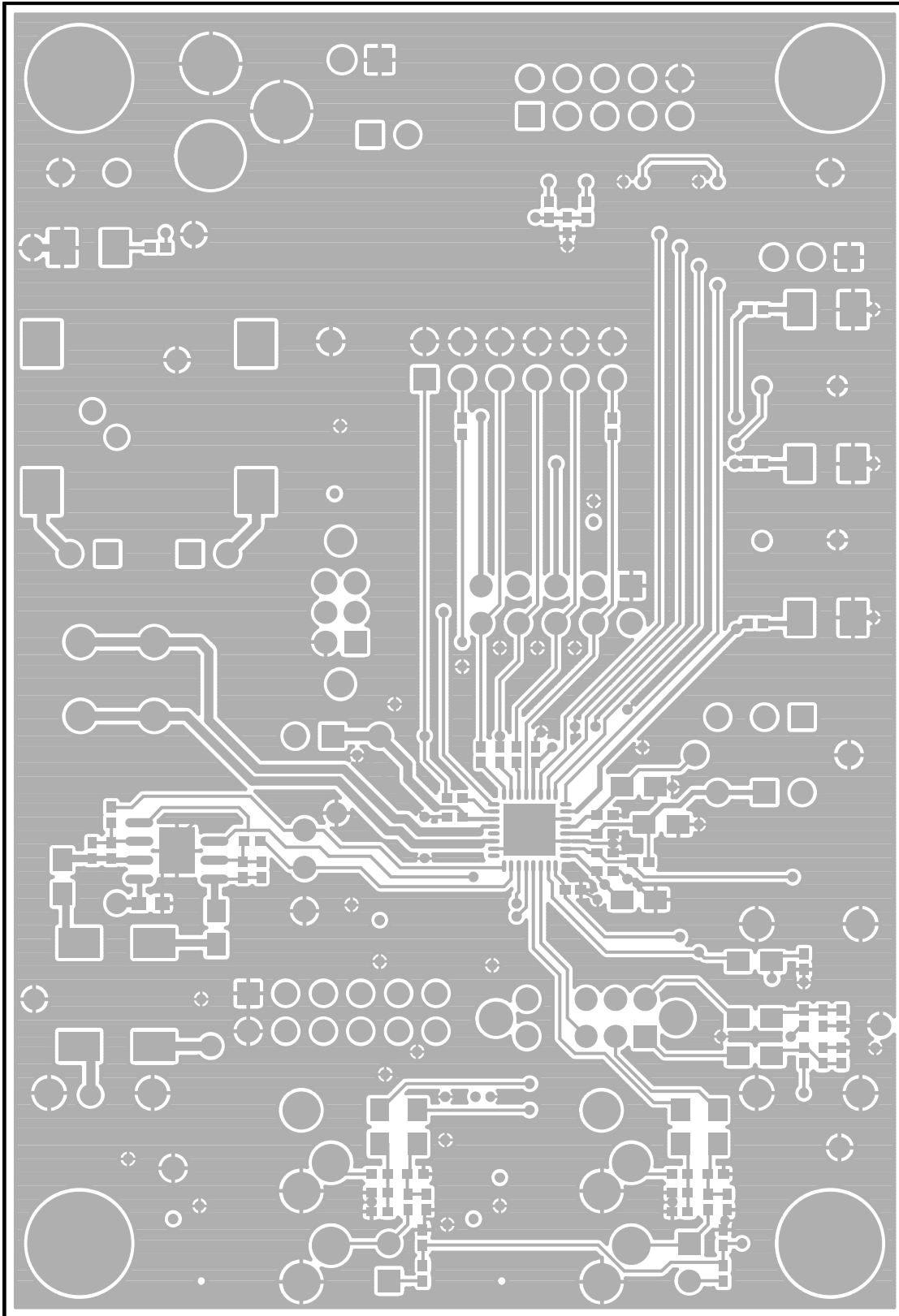

Figure 43. Evaluation Board Schematic—Communications Interface

08314-043







08314-045

Figure 45. Evaluation Board Layout—Top Copper

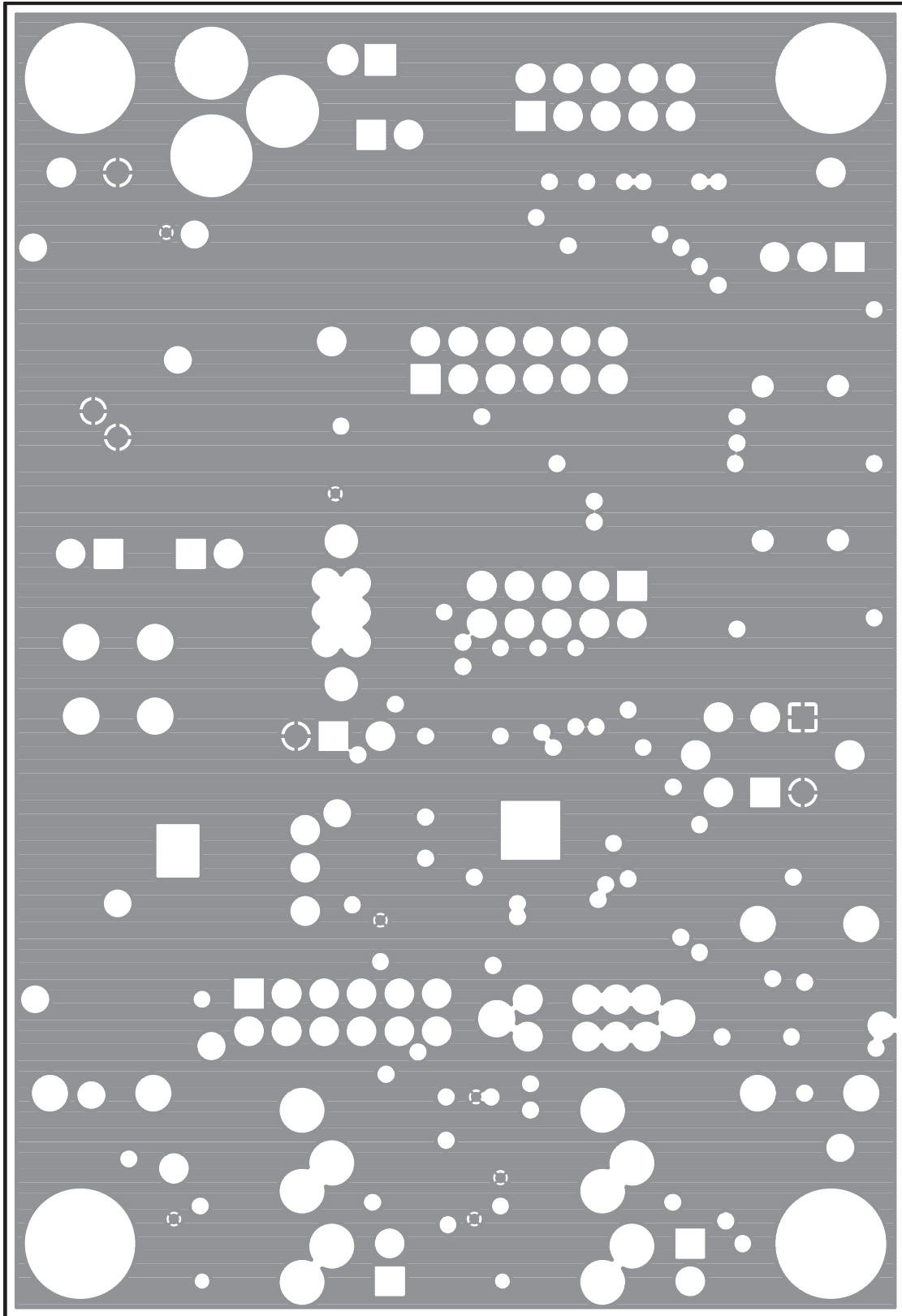

08314-046

Figure 46. Evaluation Board Layout—Power Plane

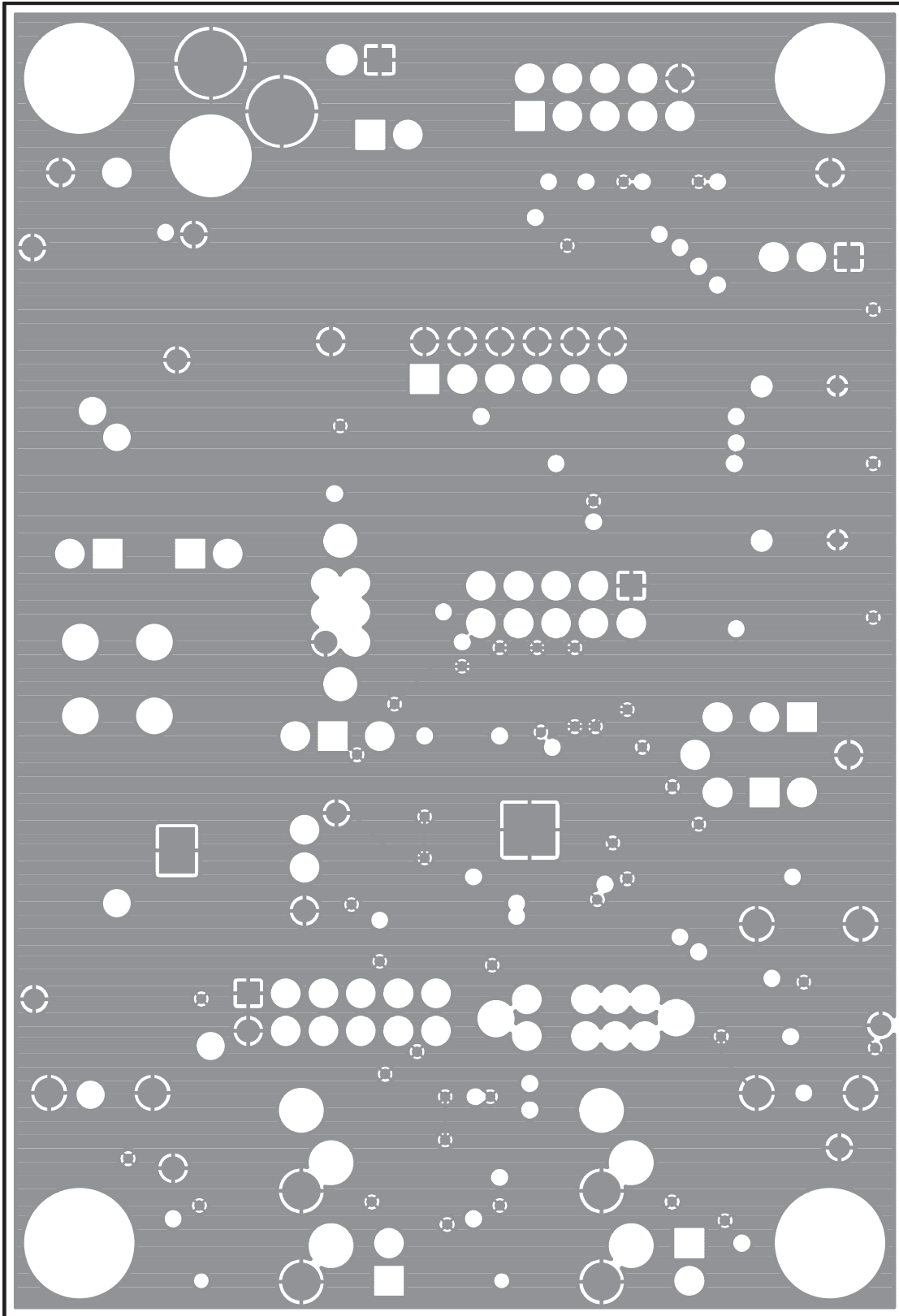

08314-017

Figure 47. Evaluation Board Layout—Ground Plane

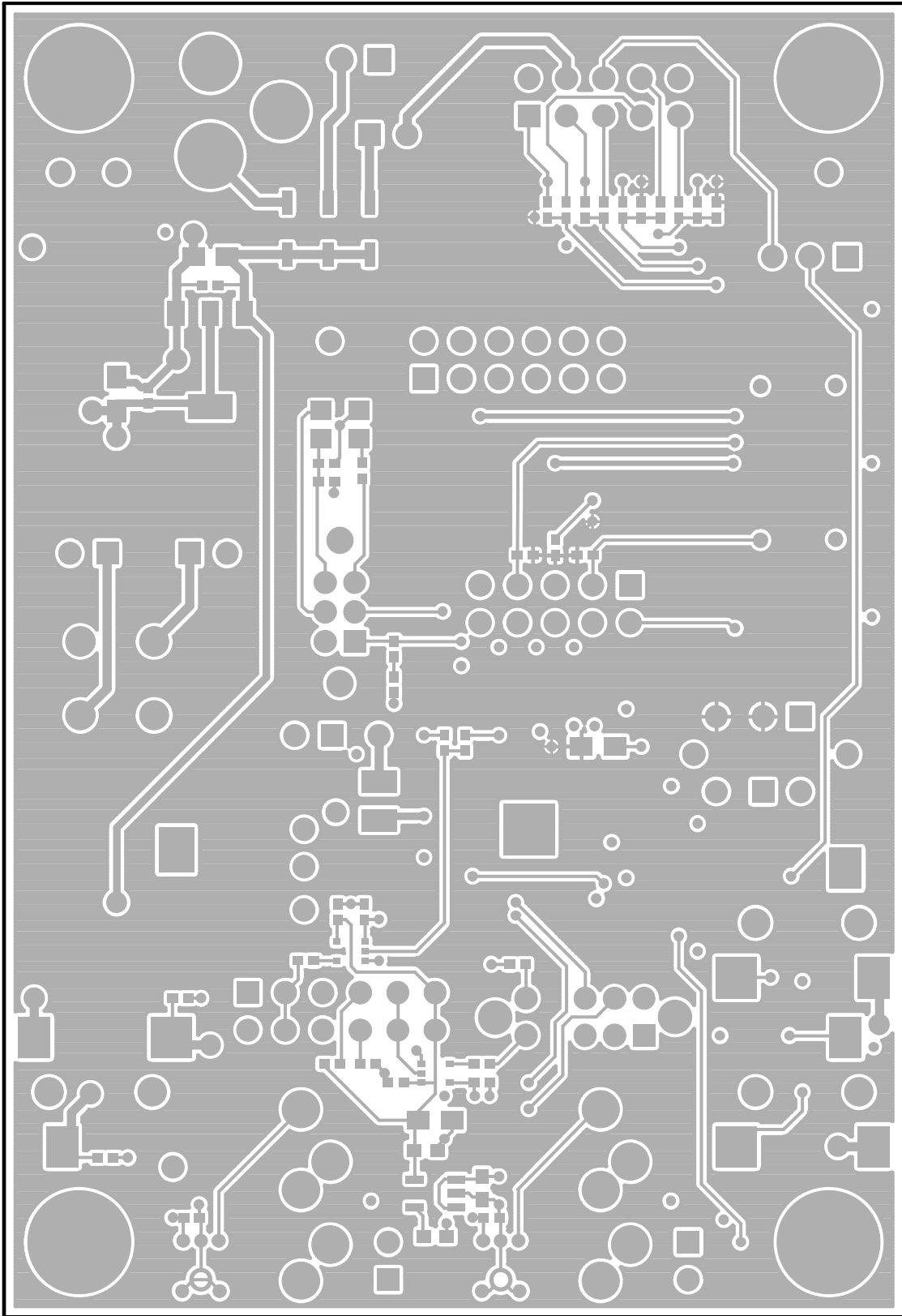

08314-048

Figure 48. Evaluation Board Layout—Bottom Copper

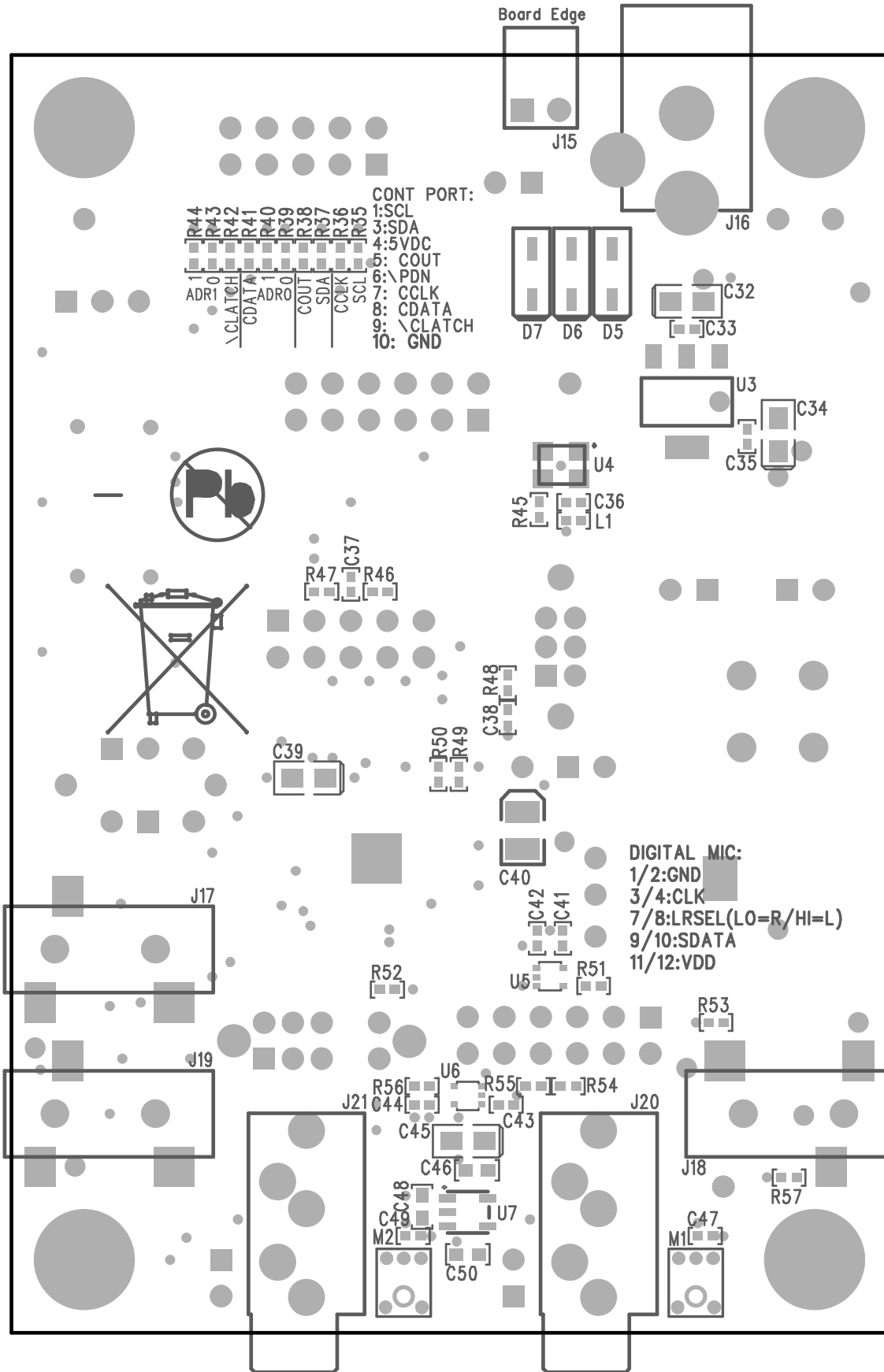

Figure 49. Evaluation Board Layout—Bottom Assembly

## ORDERING INFORMATION

### BILL OF MATERIALS

Table 1.

Qty.	Designator	Description	Value	Manufacturer	Part Number
19	C1, C2, C4 to C6, C9, C12, C30, C31, C33, C35 to C37, C41 to C44, C47, C49	Multilayer ceramic, 16 V, X7R (0402)	0.10 $\mu$ F	Panasonic EC	ECJ-0EX1C104K
7	C3, C7, C14, C32, C34, C39, C45	SMD tantalum capacitor, 0805, 6.3 V	10 $\mu$ F	Rohm Semiconductor	TCPOJ106M8R
2	C8, C11	Multilayer ceramic, 50 V, NP0 (0402)	100 pF	Murata ENA	GCM1555C1H101JZ13D
7	C10, C17, C21, C26 to C29	Do not insert	Open	Do not insert	Do not insert
3	C13, C46, C48	Multilayer ceramic, 16 V, X7R (0603)	1.0 $\mu$ F	Taiyo Yuden	EMK107BJ105KA-TR
7	C15, C16, C20, C22 to C25	Multilayer ceramic, 10 V, X7R (0805)	10 $\mu$ F	Murata ENA	GRM21BR71A106KE51L
2	C18, C19	SMD tantalum capacitor, SMD, 6.3 V	220 $\mu$ F	Nichicon	F930J227MNC
1	C38	Multilayer ceramic, 50 V, NP0 (0402)	2.2 pF	Johanson Tech	500R07S2R2BV4T
1	C40	Tantalum capacitor, 105°C SMD	47 $\mu$ F	Kemet	T520B476M010ATE035
1	C50	Multilayer ceramic, 25 V, NP0 (0603)	10 nF	TDK Corp.	C1608C0G1E103J
16	R1, R2, R13 to R17, R39, R43, R46, R47, R52 to R55, R57	Chip resistor, 1%, 63 mW, thick film, 0402	10 k $\Omega$	Rohm Semiconductor	MCR01MZPF1002
4	R3, R4, R7, R8	Chip resistor, 1%, 63 mW, thick film, 0402	301 $\Omega$	Rohm Semiconductor	MCR01MZPF3010
11	R5, R6, R9 to R12, R45, R48, R50, R51, R56	Chip resistor, 1%, 63 mW, thick film, 0402	49.9 $\Omega$	Rohm Semiconductor	MCR01MZPF49R9
2	R18, R19	Chip resistor, 1%, 125 mW, thick film, 0805	10 $\Omega$	Panasonic EC	ERJ-6ENF10R0V
7	R20, R22, R24, R27, R29, R30, R32	Chip resistor, 1%, 63 mW, thick film, 0402	49.9 k $\Omega$	Vishay/Dale	CRCW040249K9FKED
2	R21, R23	Chip resistor, 1%, 0.1 W, thick film, 0402	1 k $\Omega$	Panasonic EC	ERJ-2RKF1001X
6	R25, R26, R28, R31, R35, R37	Chip resistor, 0.1 W, thick film, 0402	0 $\Omega$	Panasonic EC	ERJ-2GE0R00X
2	R33, R34	Chip resistor, 1%, 0.1 W, thick film, 0402	2 k $\Omega$	Panasonic EC	ERJ-2RKF2001X
7	R36, R38, R40 to R42, R44, R49	Do not insert	Open	Do not insert	Do not insert
1	SP1	Speaker, 8 $\Omega$ , 0.5 W, 87 dB, 15 mm, SMD	8 $\Omega$ PC mount	Projects Unlimited	SMS-1508MS-R
1	U1	4 ADC, 4 DAC with PLL, 24-bit codec	ADAU1781	Analog Devices	<a href="#">ADAU1781</a>
1	U2	Rail-to-rail, high output current amplifier	AD8397ARDZ	Analog Devices	<a href="#">AD8397ARDZ</a>
1	U3	High accuracy low dropout 3.3 V dc voltage regulator	ADP3339AKCZ-3.3-R7	Analog Devices	<a href="#">ADP3339AKCZ-3.3-R7</a>

Qty.	Designator	Description	Value	Manufacturer	Part Number
1	U4	12.288 MHz fixed SMD oscillator, 1.8 V dc to 3.3 V dc	12.288 MHz	Abracon Corp.	AP35-12.288MHz-F-J-B
2	U5, U6	Translator 1-bit, unidirect, SC70-5	FXLP34P5X	Fairchild Semiconductor	FXLP34P5X
1	U7	Adjustable low dropout voltage regulator	ADP1711AUJZ-1.8-R7	Analog Devices	ADP1711AUJZ-1.8-R7
2	M1, M2	Omnidirectional microphone with bottom port and analog output	INMP401	InvenSense	INMP401
2	S1, S2	Tact switch long stroke (normally open)	70 gf	Omron Electronics	B3M-6009
1	S3	DPDT slide switch vertical	DPDT slide	E-Switch	EG2207
1	S4	Switch slide, DP3T, PC mount, L = 4 mm	2P3T slide	E-Switch	EG2305
1	L1	Chip ferrite bead	600 $\Omega$ at 100 MHz	TDK Corp.	MMZ1005S601C
8	J1, J5, J6, J9 to J11, J13, J14	2-pin header unshrouded jumper, 0.10", use shunt Tyco 881545-2	2-pin jumper	Sullins Connector Solutions	PBC02SAAN or cut PBC36SAAN
1	J2	10-way shroud polarized header	2 $\times$ 5	3M	N2510-6002RB
1	J3	3-position SIP header	3-pin jumper	Sullins Connector Solutions	PBC03SAAN or cut PBC36SAAN
1	J4	Header, 12-way, unshrouded	2 $\times$ 6	Sullins Connector Solutions	PBC06DAAN
1	J7	Header, 10-way, unshrouded	2 $\times$ 5	Sullins Connector Solutions	PBC05DAAN
1	J8	2-position spring terminal block	14-30 AWG spring clamp	On-Shore Tech	OSTHT020080
1	J12	12-way socket unshrouded	2 $\times$ 6	Sullins Connector Solutions	PPPC062LFBN-RC
1	J15	2-pin header R/A, 100 mil gold	22-12-2-24	Molex	22-12-2024
1	J16	Power supply connector	RAPC722X	Switchcraft, Inc.	RAPC722X
3	J17 to J19	Stereo mini-jack	SJ-3523-SMT	CUI Inc.	SJ-3523-SMT
2	J20, J21	Stereo mini-jack with tip and ring normal	STX-3150-5C	Kycon	STX-3150-5C
2	D1, D4	Red diffused, 6.0 millicandela, 635 nm, 1206	Red diffused	Lumex Opto	SML-LX1206IW-TR
1	D2	Green diffused, 10 millicandela, 565 nm, 1206	Green diffused	Lumex Opto	SML-LX1206GW-TR
1	D3	Yellow diffused, 4.0 millicandela, 585 nm, 1206	Yellow diffused	CML Innovative Tech	CMD15-21VYD/TR8
3	D5 to D7	Schottky, 30 V, 0.5 A, SOD123 diode	Schottky	ON Semiconductor	MBR0530T1G
13	TP1 to TP13	Mini-test point, white, 0.1" OD	5002	Keystone Electronics	5002

## RELATED LINKS

Resource	Description
<a href="#">ADAU1781</a>	Product Page, SigmaDSP Low-Noise Stereo Audio Codec for Portable Applications
<a href="#">INMP401</a>	Product Page, Omnidirectional Microphone with Bottom Port and Analog Output
<a href="#">AN-1006</a>	Application Note, <i>Using the EVAL-ADUSB2EBZ</i>



## NOTES

I<sup>2</sup>C refers to a communications protocol originally developed by Philips Semiconductors (now NXP Semiconductors).



### ESD Caution

**ESD (electrostatic discharge) sensitive device.** Charged devices and circuit boards can discharge without detection. Although this product features patented or proprietary protection circuitry, damage may occur on devices subjected to high energy ESD. Therefore, proper ESD precautions should be taken to avoid performance degradation or loss of functionality.

### Legal Terms and Conditions

By using the evaluation board discussed herein (together with any tools, components documentation or support materials, the "Evaluation Board"), you are agreeing to be bound by the terms and conditions set forth below ("Agreement") unless you have purchased the Evaluation Board, in which case the Analog Devices Standard Terms and Conditions of Sale shall govern. Do not use the Evaluation Board until you have read and agreed to the Agreement. Your use of the Evaluation Board shall signify your acceptance of the Agreement. This Agreement is made by and between you ("Customer") and Analog Devices, Inc. ("ADI"), with its principal place of business at One Technology Way, Norwood, MA 02062, USA. Subject to the terms and conditions of the Agreement, ADI hereby grants to Customer a free, limited, personal, temporary, non-exclusive, non-sublicensable, non-transferable license to use the Evaluation Board FOR EVALUATION PURPOSES ONLY. Customer understands and agrees that the Evaluation Board is provided for the sole and exclusive purpose referenced above, and agrees not to use the Evaluation Board for any other purpose. Furthermore, the license granted is expressly made subject to the following additional limitations: Customer shall not (i) rent, lease, display, sell, transfer, assign, sublicense, or distribute the Evaluation Board; and (ii) permit any Third Party to access the Evaluation Board. As used herein, the term "Third Party" includes any entity other than ADI, Customer, their employees, affiliates and in-house consultants. The Evaluation Board is NOT sold to Customer; all rights not expressly granted herein, including ownership of the Evaluation Board, are reserved by ADI. CONFIDENTIALITY. This Agreement and the Evaluation Board shall all be considered the confidential and proprietary information of ADI. Customer may not disclose or transfer any portion of the Evaluation Board to any other party for any reason. Upon discontinuation of use of the Evaluation Board or termination of this Agreement, Customer agrees to promptly return the Evaluation Board to ADI. ADDITIONAL RESTRICTIONS. Customer may not disassemble, decompile or reverse engineer chips on the Evaluation Board. Customer shall inform ADI of any occurred damages or any modifications or alterations it makes to the Evaluation Board, including but not limited to soldering or any other activity that affects the material content of the Evaluation Board. Modifications to the Evaluation Board must comply with applicable law, including but not limited to the RoHS Directive. TERMINATION. ADI may terminate this Agreement at any time upon giving written notice to Customer. Customer agrees to return to ADI the Evaluation Board at that time. LIMITATION OF LIABILITY. THE EVALUATION BOARD PROVIDED HEREUNDER IS PROVIDED "AS IS" AND ADI MAKES NO WARRANTIES OR REPRESENTATIONS OF ANY KIND WITH RESPECT TO IT. ADI SPECIFICALLY DISCLAIMS ANY REPRESENTATIONS, ENDORSEMENTS, GUARANTEES, OR WARRANTIES, EXPRESS OR IMPLIED, RELATED TO THE EVALUATION BOARD INCLUDING, BUT NOT LIMITED TO, THE IMPLIED WARRANTY OF MERCHANTABILITY, TITLE, FITNESS FOR A PARTICULAR PURPOSE OR NON-INFRINGEMENT OF INTELLECTUAL PROPERTY RIGHTS. IN NO EVENT WILL ADI AND ITS LICENSORS BE LIABLE FOR ANY INCIDENTAL, SPECIAL, INDIRECT, OR CONSEQUENTIAL DAMAGES RESULTING FROM CUSTOMER'S POSSESSION OR USE OF THE EVALUATION BOARD, INCLUDING BUT NOT LIMITED TO LOST PROFITS, DELAY COSTS, LABOR COSTS OR LOSS OF GOODWILL. ADI'S TOTAL LIABILITY FROM ANY AND ALL CAUSES SHALL BE LIMITED TO THE AMOUNT OF ONE HUNDRED US DOLLARS (\$100.00). EXPORT. Customer agrees that it will not directly or indirectly export the Evaluation Board to another country, and that it will comply with all applicable United States federal laws and regulations relating to exports. GOVERNING LAW. This Agreement shall be governed by and construed in accordance with the substantive laws of the Commonwealth of Massachusetts (excluding conflict of law rules). Any legal action regarding this Agreement will be heard in the state or federal courts having jurisdiction in Suffolk County, Massachusetts, and Customer hereby submits to the personal jurisdiction and venue of such courts. The United Nations Convention on Contracts for the International Sale of Goods shall not apply to this Agreement and is expressly disclaimed.

©2010–2015 Analog Devices, Inc. All rights reserved. Trademarks and registered trademarks are the property of their respective owners.  
UG08314-0-1/15(A)



www.analog.com