

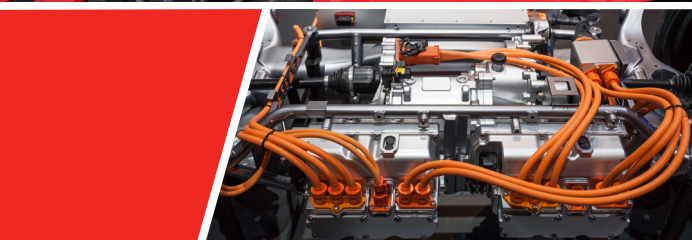

Silicon Carbide Semiconductor Products

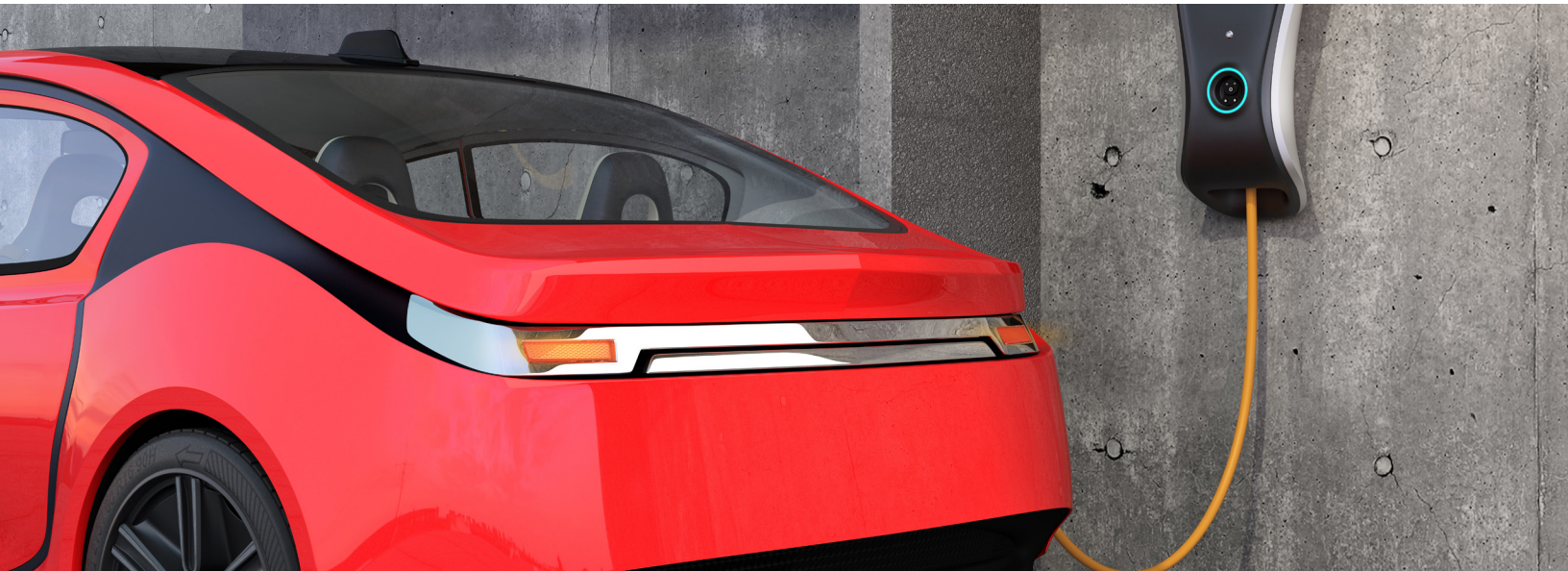

Overview	3
Higher Switching Efficiency	4
SiC Discretes and Modules Nomenclature	5
Discrete Products.....	6
Power Modules.....	7
AgileSwitch Gate Driver Solutions.....	9
SiC Reference Designs	10
Notes.....	11

Breakthrough Technology Combines High Performance With Low Losses

Silicon Carbide (SiC) semiconductors provide an innovative option for power electronic designers looking for improved system efficiency, smaller form factor and higher operating temperature in products covering industrial, transportation/automotive, medical, aerospace/aviation, defense and communication market segments. Our next-generation SiC MOSFETs and SiC SBDs are designed with higher repetitive Unclamped Inductive Switching (UIS) capability at rated on-resistance or current. Our SiC MOSFETs maintain high UIS capability at approximately 10–25 Joules Per Square Centimeter (J/cm²) and robust short circuit protection. Microchip’s SiC Schottky Barrier Diodes (SBDs) are designed with balanced surge current, forward voltage, thermal resistance and thermal capacitance ratings at low reverse current for lower switching loss. In addition, our SiC MOSFET and SiC SBD die can be paired together for use in modules. SiC MOSFET and SiC SBD products from Microchip will be qualified to the AEC-Q101 standard.

- Extremely-low switching losses improves system efficiency
- High-power density for smaller footprint to reduce size and weight
- 3x more thermally conductive than silicon
- Reduced sink requirements to achieve smaller size, lighter weight
- High-temperature operation improves reliability at increased power density
- Proven reliability/ruggedness, supply chain and support with Microchip quality, supply and support

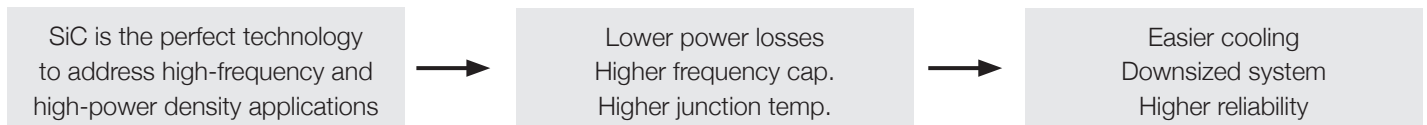

- **Quality:** proven reliability and ruggedness
- **Supply:** risk averse approach throughout the supply chain
- **Support:** standard discrete, die, module, and gate drive solutions with design and application support for customers

SiC is the ideal technology for higher-switching-frequency, higher-efficiency and higher-power (>650 V) applications.

Target markets and applications include:

- Industrial—Motor drives, welding, UPS, SMPS, induction heating
- Transportation/automotive—Electric Vehicle (EV) battery chargers, on board chargers, Hybrid Electric Vehicle (HEV) powertrains, DC-DC converters, energy recovery
- Smart energy—Photovoltaic (PV) inverters, wind turbines
- Medical—MRI power supply, X-ray power supply
- Commercial aviation—Actuation, air conditioning, power distribution
- Defense—Motor drives, auxiliary power supplies, integrated vehicle systems

SiC MOSFET and SiC Schottky Barrier Diode products increase your system efficiency over silicon MOSFET and IGBT solutions while lowering your total cost of ownership by enabling downsized systems and smaller/lower-cost cooling.

Advanced R&D and Manufacturing

Design

- TCAD design and process simulators
- Mask-making and layout
- Finite Element Analysis (FEA) and Electrothermal simulation capabilities
- Design for ruggedness

Process

- Automotive quality internal fab and foundry
- Proprietary gate oxide process with exceptional reliability
- Specialized tools for SiC processes - implant, anneal, etch, furnaces, metal deposition

Analytical and Support

- Full FA capabilities in-house
- SEM/EDAX
- Thermal imaging
- Photo Emission Microscope system (Phemos 1000)

Reliability Testing and Screening

- AEC-Q101
- Full suite of tools and equipment for burn-ins and reliability screening
- Sonoscan and X-ray

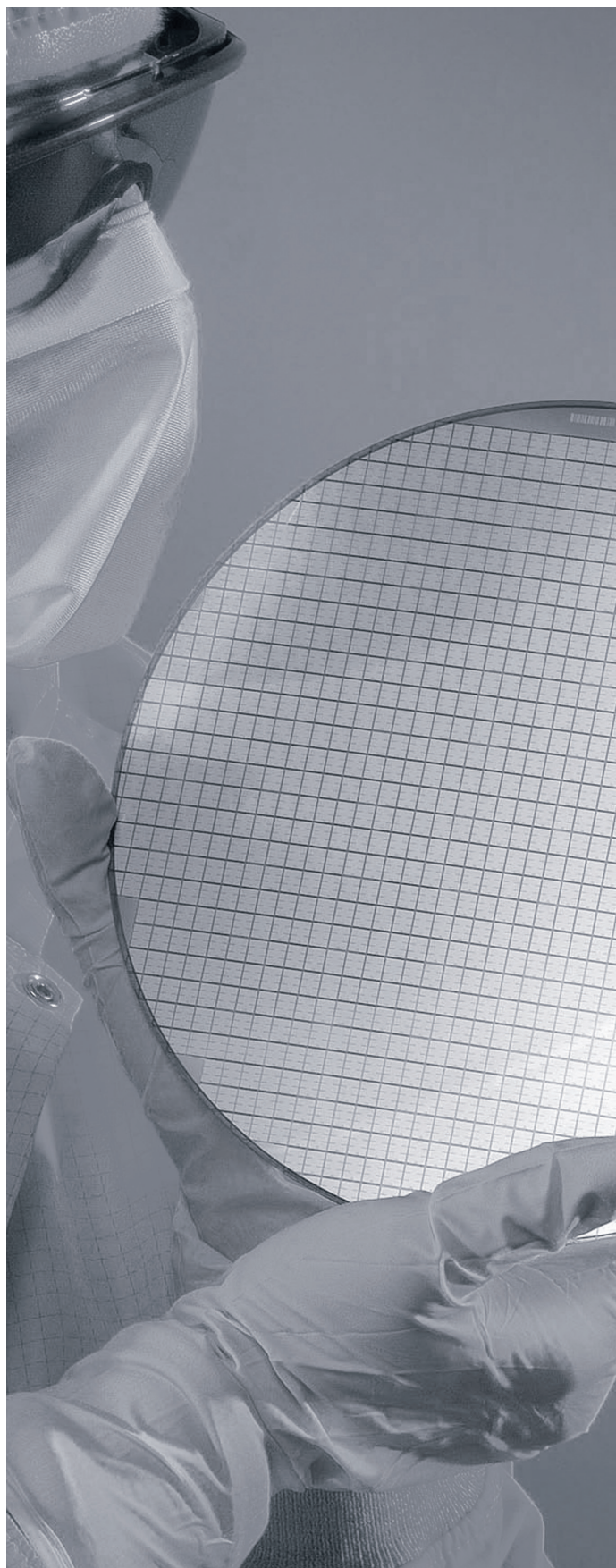

SiC Discretes and Modules Nomenclature

SiC Discretes

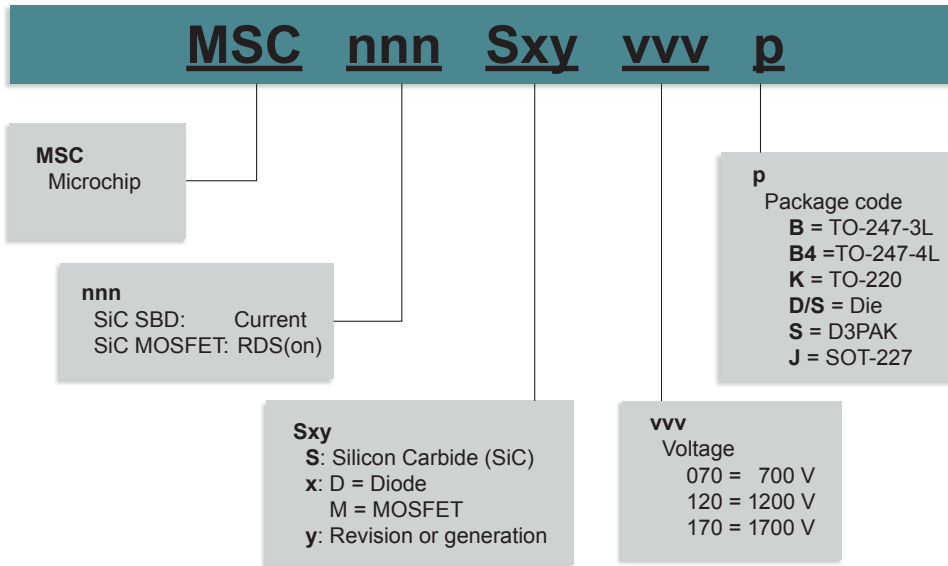

SP6LI SiC Power Modules

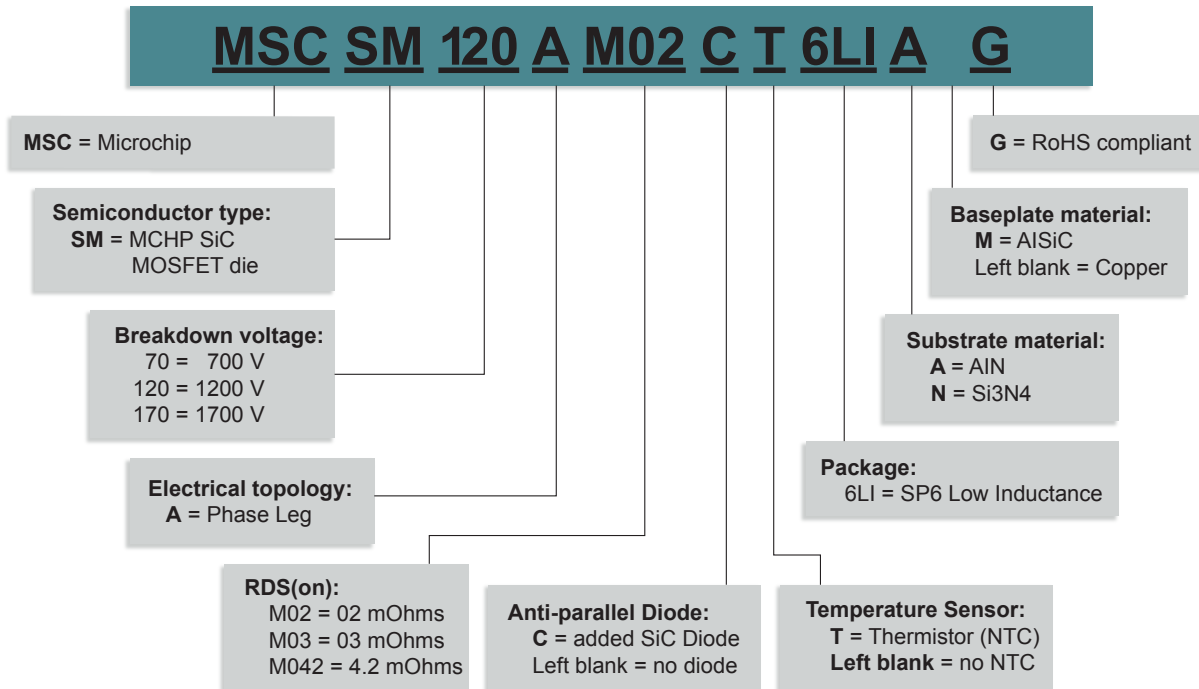

SiC Schottky Barrier Diodes

Part Number	Voltage (V)	I _F (A)	Package	
MSC010SDA070B	700	10	TO-247	
MSC010SDA070K		10	TO-220	
MSC030SDA070B		30	TO-247	
MSC030SDA070K		30	TO-220	
MSC050SDA070B		50	TO-247	
MSC010SDA120B		1200	10	TO-247
MSC010SDA120K	10		TO-220	
MSC015SDA120B	15		TO-247	
MSC015SDA120K	15		TO-220	
MSC030SDA120B	30		TO-247	
MSC030SDA120K	30		TO-220	
MSC030SDA120S	30		D3PAK	
MSC050SDA120B	50		TO-247	
MSC050SDA120S	50		D3PAK	
MSC010SDA170B	1700		10	TO-247
MSC030SDA170B			30	TO-247
MSC050SDA170B			50	TO-247

SiC MOSFETs

Part Number	Voltage (V)	RD _{son} (mΩ)	Package
MSC090SMA070B	700	90	TO-247
MSC090SMA070S			D3PAK
MSC060SMA070B		60	TO-247
MSC060SMA070B4			TO-247-4L
MSC060SMA070S			D3PAK
MSC035SMA070B		35	TO-247
MSC035SMA070B4			TO-247-4L
MSC035SMA070S			D3PAK
MSC015SMA070B		15	TO-247
MSC015SMA070B4			TO-247-4L
MSC015SMA070S			D3PAK
MSC080SMA120B		1200	80
MSC080SMA120B4	TO-247-4L		
MSC080SMA120S	D3PAK		
MSC080SMA120J	40		SOT-227
MSC040SMA120B			TO-247
MSC040SMA120B4			TO-247-4L
MSC040SMA120S	25		D3PAK
MSC040SMA120J			SOT-227
MSC025SMA120B			TO-247
MSC025SMA120B4	TO-247-4L		
MSC025SMA120S	750		D3PAK
MSC025SMA120J			SOT-227
MSC750SMA170B		TO-247	
MSC750SMA170B4	35	TO-247-4L	
MSC750SMA170S		D3PAK	
MSC035SMA170B		TO-247	
MSC035SMA170B4	TO-247-4L		
MSC035SMAS170S	D3PAK		

SiC MOSFET Features and Benefits

Characteristics	SiC vs. Si	Results	Benefits
Breakdown field (MV/cm)	10x higher	Lower on-resistance	Higher efficiency
Electron sat. velocity (cm/s)	2x higher	Faster switching	Size reduction
Bandgap energy (ev)	3x higher	Higher junction temperature	Improved cooling
Thermal conductivity (W/m.K)	3x higher	Higher power density	Higher current capabilities
Positive temperature coefficient		Self regulation	Easy paralleling

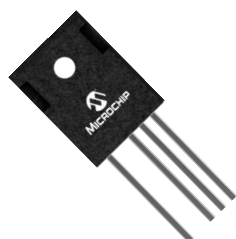

TO-247-4L

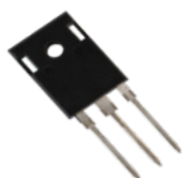

TO-247-3L

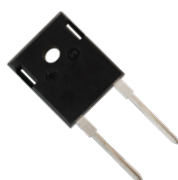

TO-247-2L

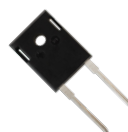

TO-220



TO-268



SOT-227

Power Module Advantages

- High-speed switching
- Low switching losses
- Low-input capacitance
- High-power density
- Low-profile packages
- Minimum parasitic inductance
- Lower system cost
- Standard and custom modules
- 30+ years design experience

Part Number	Type	Electrical Topology	Voltage (V)	RDSon (mΩ)	Current (A) Tc = 80 C	Package	Notes	
MSC2X30/31SDA070J	SiC Diode Module	Dual diode (Anti-parallel/parallel)	700	-	30	SOT-227		
MSC2X50/51SDA070J				-	50	SOT-227		
MSC2X100/101SDA070J				-	100	SOT-227		
MSC2X30/31SDA120J			-	30	SOT-227			
MSC2X50/51SDA120J			-	50	SOT-227			
MSC2X100/101SDA120J			-	100	SOT-227			
MSCDC50H701AG		Full bridge	700	-	50	SP1		
MSC50DC70HJ				-	50	SOT-227		
MSCDC100H70AG				-	100	SP6		
MSCDC200H70AG				-	200	SP6		
MSCDC50H1201AG				-	50	SP1		
MSC50DC120HJ				-	50	SOT-227		
MSCDC100H120AG			-	100	SP6			
MSCDC200H120AG			-	200	SP6			
MSCDC100H170AG			-	100	SP6C			
MSCDC200H170AG			-	200	SP6C			
MSCDC50H1701AG			-	50	SP1			
MSC50DC170HJ			-	50	SOT-227			
MSCDC100A70D1PAG			Phase leg	700	-	100	D1P	
MSCDC150A70D1PAG					-	150	D1P	
MSCDC200A70D1PAG					-	200	D1P	
MSCDC300A70AG					-	300	SP6	
MSCDC450A70AG					-	450	SP6	
MSCDC600A70AG					-	600	SP6	
MSCDC100A120D1PAG				-	100	D1P		
MSCDC150A120D1PAG				-	150	D1P		
MSCDC200A120D1PAG				-	200	D1P		
MSCDC300A120AG		-		300	SP6			
MSCDC450A120AG		-		450	SP6			
MSCDC600A120AG		-		600	SP6			
MSCDC300A170AG		-		300	SP6C			
MSCDC450A170AG		-		450	SP6C			
MSCDC600A170AG		-		600	SP6C			
MSCDC100A170D1PAG		-		100	D1P			
MSCDC150A170D1PAG		-		150	D1P			
MSCDC200A170D1PAG		-		200	D1P			
MSCDC100KK70D1PAG		Dual common cathode		700	-	100	D1P	
MSCDC150KK70D1PAG					-	150	D1P	
MSCDC200KK70D1PAG					-	200	D1P	
MSCDC100KK120D1PAG			-	100	D1P			
MSCDC150KK120D1PAG			-	150	D1P			
MSCDC200KK120D1PAG			-	200	D1P			

Part Number	Type	Electrical Topology	Voltage (V)	RDSon (mΩ)	Current (A) Tc = 80 C	Package	Notes	
MSCDC100KK170D1PAG	SiC Diode Module	Dual common cathode	1700	-	100	D1P		
MSCDC150KK170D1PAG				-	150	D1P		
MSCDC200KK170D1PAG				-	200	D1P		
MSCDC50X701AG		Three phase bridge	1200	-	50	SP1		
MSCDC50X1201AG				-	50	SP1		
MSCDC50X1701AG			1700	-	50	SP1		
MSC100SM70JCU2	SiC MOSFET Module	Boost chopper	700	15	97	SOT-227		
MSC100SM70JCU3				15	97	SOT-227		
MSC40SM120JCU2			1200	40	44	SOT-227		
MSC70SM120JCU2				25	71	SOT-227		
MSC130SM120JCU2				12.5	138	SOT-227		
MSCSM120DAM11CT3AG				11	202	SP3F		
MSC40SM120JCU3		40		44	SOT-227			
MSC70SM120JCU3		25		71	SOT-227			
MSC130SM120JCU3		Buck chopper	700	12.5	138	SOT-227		
MSCSM120SKM11CT3AG				11	202	SP3F		
MSCSM70HM19CT3AG			Full bridge	1200	15	97	SP3F	
MSCSM120HM31CT3AG					25	71	SP3F	
MSCSM120HM16CT3AG				12.5	138	SP3F		
MSCSM120HM50CT3AG				40	44	SP3F		
MSCSM70AM19CT1AG		Phase leg		700	15	97	SP1F	
MSCSM70AM07CT3AG					5	276	SP3F	
MSCSM70AM10CT3AG			7.5		188	SP3F		
MSCSM70AM025CD3AG			2.5		538	D3		
MSCSM70AM025CT6AG			2.5		538	SP6C		
MSCSM120AM16CT1AG			1200		12.5	138	SP1F	
MSCSM120AM31CT1AG				25	71	SP1F		
MSCSM120AM50CT1AG				40	44	SP1F		
MSCSM120AM08CT3AG				6.25	268	SP3F		
MSCSM120AM11CT3AG				8.33	202	SP3F		
MSCSM120AM042CD3AG	4.2			394	D3	2, 3		
MSCSM120AM027CD3AG	2.7		584	D3	2, 3			
MSCSM120AM042CT6AG	4.2	394	SP6C					
MSCSM120AM027CT6AG	2.7	584	SP6C					
MSCSM70VM19C3AG	Vienna phase leg	700	15	97	SP3F			
MSCSM70VM10C4AG			7.5	97	SP4			
MSCSM70TAM19CT3AG	Three hase bridge Triple phase leg	700	15	97	SP3F			
MSCSM70TAM10CTPAG			7.5	186	SP6P			
MSCSM70TAM05TPAG		5	273	SP6P				
MSCSM120TAM31CT3AG		1200	25	71	SP3F			
MSCSM120TAM16CTPAG			12.5	136	SP6P			
MSCSM120TAM11CTPAG			8.33	200	SP6P			
MSCSM70AM025CT6LIAG	Low Inductance SiC MOSFET Module		Phase leg	700	2.5	538	SP6C LI	
MSCSM120AM042CT6LIAG		1200		4.2	394	SP6C LI	1	
MSCSM120AM03CT6LIAG		2.5		641	SP6C LI	1		
MSCSM120AM02CT6LIAG		2.1		754	SP6C LI	1		

1, 2, 3 Refer to Gate Driver Solutions table on page 9

AgileSwitch Gate Driver Solutions

Gate Driver Reference*	Gate Driver Type	Gate Driver Part Number	Adapter Board Part Number
1	Core	2ASC-12A1HP	SP6CA1
2	Core	2ASC-12A1HP	62CA1
3	Plug & Play	62EM1-00001	Not Applicable

*Refer to footnotes in SiC product tables

2ASC-12A1HP

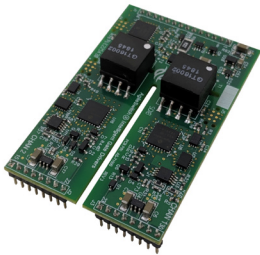

Improve switching efficiency and EMI performance, all while protecting your valuable SiC devices. The AgileSwitch 2ASC dual-channel high performance gate driver cores are designed to take on your SiC implementation challenges.

62CA1 and SP6CA1 (Shown with 2ASC-12A1HP connected)

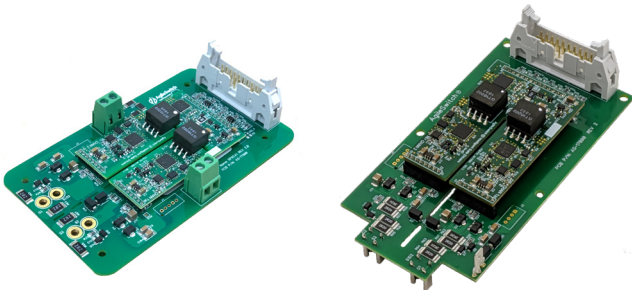

Compatible with the AgileSwitch 2ASC Gate Driver Cores, the family of Module Adapter Boards provides a platform to rapidly evaluate and optimize new SiC power devices. Standard offerings include a reference design for the 1200V SP6LI (SP6CA1) and 1200V D3 (62CA1).

62EM1

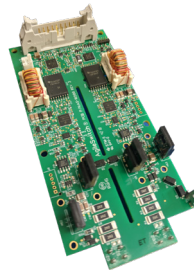

Control, monitor, and protect the latest 62 mm SiC devices using the Plug-and-Play 62EM Gate Driver Boards. Designed for traction applications, the 62EM can drive up to 1.7 kV devices at 100 kHz with configurable fault settings and patented Augmented Switching technology.

User-Friendly Reference Designs

Microchip and our partner ecosystem provide open-source, user friendly SiC MOSFET reference design solutions that enable faster time to market for customers using our SiC MOSFETs and power modules. You can use isolated dual-gate driver reference designs with our SiC MOSFETs in a number of SiC topologies.

SiC Reference Designs

Part Number	Gate Drive or Line Voltage	KHz, max	Per Side Drive Power (W)	Description
MSCSICMDD/REF	-5 to +20 V	400	8 W	SiC discrete gate driver board
MSCSICSP3/REF2	-5 to +20 V	400	16 W	SiC SP3 module driver board
MSCSICSP6L/REF3	-5 to +20 V	400	16 W	SiC SP6LI module driver board
MSCSICPFC/REF5	In: 400 Vrms, Out: 700 Vdc	140	30 kW	30 kW 3-phase Vienna PFC (design files only)

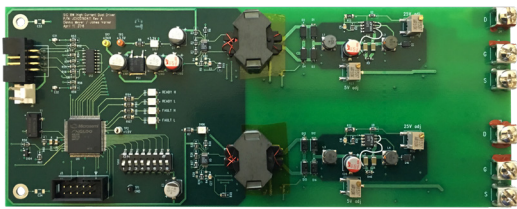

The MSCSICMDD/REF1 is a switch-configurable high/low-side driver with half bridges or independent drive.

- 400 kHz maximum switching frequency
- 8W of gate drive power per side
- 30A peak output current
- -5V/+20 V gate drive voltage
- ±100 kV/uS capability
- Galvanic isolation of more than 2000V on both gate drivers

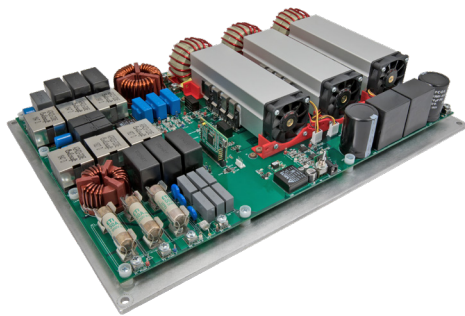

The MSCSICPFC/REF5 is a Vienna 3-Phase PFC reference design for Hybrid Electric Vehicle/Electric Vehicle (HEV/ EV) charger and high-power switch mode power supply applications.

- 30 kW Vienna rectifier topology at 98.6 % peak efficiency
- 380/400 VAC, 50 Hz/60 Hz input voltage with 700V DC output voltage
- 140 kHz pulse-width modulation switching frequency
- < 5% current THD at half and full loads
- 700 V SiC MOSFETs and 1200 V SiC diodes
- dsPIC33CH using 3-level modulation for digital control



SP3F standard package compatible

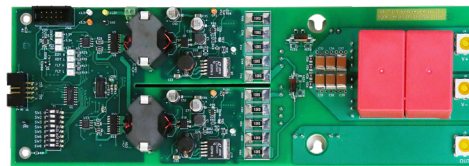

The MSCSICSP3/REF2 is a half bridge driver compatible with SP3F standard package modules.

- 400 kHz maximum switching frequency
- 16W of gate drive power per side
- 30A peak output current
- -5 V/+20 V gate drive voltage
- ±100 kV/uS capability
- Galvanic isolation of more than 2000 V on both gate drivers

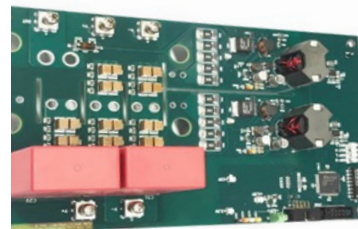

The MSCSICSP6/REF3 is a half bridge driver for the low inductance SP6LI power modules.

- Stray inductance < 3 nH to fully benefit from SiC
- Designed to be easy to parallel
- Up to 1200 V and 586 A
- Half Bridge Driver
- Up to 400 kHz switching frequency
- 12 V VIN supply
- Capable of 16 W of gate drive power/side
- 30 A Peak Source output current
- Min.100 KV/μS CMTI

Support

Microchip is committed to supporting its customers in developing products faster and more efficiently. We maintain a worldwide network of field applications engineers and technical support ready to provide product and system assistance. For more information, please visit www.microchip.com:

- Technical Support: www.microchip.com/support
- Evaluation samples of any Microchip device: www.microchip.com/sample
- Knowledge base and peer help: www.microchip.com/forums
- Sales and Global Distribution: www.microchip.com/sales

Training

If additional training interests you, Microchip offers several resources including in-depth technical training and reference material, self-paced tutorials and significant online resources.

- Overview of Technical Training Resources: www.microchip.com/training
- MASTERS Conferences: www.microchip.com/masters
- Developer Help Website: www.microchip.com/developerhelp
- Technical Training Centers: www.microchip.com/seminars

Sales Office Listing

AMERICAS

Atlanta, GA
Tel: 678-957-9614

Austin, TX
Tel: 512-257-3370

Boston, MA
Tel: 774-760-0087

Chandler, AZ (HQ)
Tel: 480-792-7200

Chicago, IL
Tel: 630-285-0071

Dallas, TX
Tel: 972-818-7423

Detroit, MI
Tel: 248-848-4000

Houston, TX
Tel: 281-894-5983

Indianapolis, IN
Tel: 317-773-8323
Tel: 317-536-2380

Los Angeles, CA
Tel: 949-462-9523
Tel: 951-273-7800

Raleigh, NC
Tel: 919-844-7510

New York, NY
Tel: 631-435-6000

San Jose, CA
Tel: 408-735-9110
Tel: 408-436-4270

Canada - Toronto
Tel: 905-695-1980

EUROPE

Austria - Wels
Tel: 43-7242-2244-39

Denmark - Copenhagen
Tel: 45-4485-5910

Finland - Espoo
Tel: 358-9-4520-820

France - Paris
Tel: 33-1-69-53-63-20

Germany - Garching
Tel: 49-8931-9700

Germany - Haan
Tel: 49-2129-3766-400

Germany - Heilbronn
Tel: 49-7131-67-3636

Germany - Karlsruhe
Tel: 49-721-62537-0

Germany - Munich
Tel: 49-89-627-144-0

Germany - Rosenheim
Tel: 49-8031-354-560

EUROPE

Israel - Ra'anana
Tel: 972-9-744-7705

Italy - Milan
Tel: 39-0331-742611

Italy - Padova
Tel: 39-049-7625286

Netherlands - Drunen
Tel: 31-416-690399

Norway - Trondheim
Tel: 47-7289-7561

Poland - Warsaw
Tel: 48-22-3325737

Romania - Bucharest
Tel: 40-21-407-87-50

Spain - Madrid
Tel: 34-91-708-08-90

Sweden - Gothenberg
Tel: 46-31-704-60-40

Sweden - Stockholm
Tel: 46-8-5090-4654

UK - Wokingham
Tel: 44-118-921-5800

ASIA/PACIFIC

Australia - Sydney
Tel: 61-2-9868-6733

China - Beijing
Tel: 86-10-8569-7000

China - Chengdu
Tel: 86-28-8665-5511

China - Chongqing
Tel: 86-23-8980-9588

China - Dongguan
Tel: 86-769-8702-9880

China - Guangzhou
Tel: 86-20-8755-8029

China - Hangzhou
Tel: 86-571-8792-8115

China - Hong Kong SAR
Tel: 852-2943-5100

China - Nanjing
Tel: 86-25-8473-2460

China - Qingdao
Tel: 86-532-8502-7355

China - Shanghai
Tel: 86-21-3326-8000

China - Shenyang
Tel: 86-24-2334-2829

China - Shenzhen
Tel: 86-755-8864-2200

China - Suzhou
Tel: 86-186-6233-1526

China - Wuhan
Tel: 86-27-5980-5300

China - Xiamen
Tel: 86-592-2388138

China - Xian
Tel: 86-29-8833-7252

ASIA/PACIFIC

China - Zhuhai
Tel: 86-756-321-0040

India - Bangalore
Tel: 91-80-3090-4444

India - New Delhi
Tel: 91-11-4160-8631

India - Pune
Tel: 91-20-4121-0141

Japan - Osaka
Tel: 81-6-6152-7160

Japan - Tokyo
Tel: 81-3-6880-3770

Korea - Daegu
Tel: 82-53-744-4301

Korea - Seoul
Tel: 82-2-554-7200

Malaysia - Kuala Lumpur
Tel: 60-3-7651-7906

Malaysia - Penang
Tel: 60-4-227-8870

Philippines - Manila
Tel: 63-2-634-9065

Singapore
Tel: 65-6334-8870

Taiwan - Hsin Chu
Tel: 886-3-577-8366

Taiwan - Kaohsiung
Tel: 886-7-213-7830

Taiwan - Taipei
Tel: 886-2-2508-8600

Thailand - Bangkok
Tel: 66-2-694-1351

Vietnam - Ho Chi Minh
Tel: 84-28-5448-2100

2/27/20



www.microchip.com

Microchip Technology Inc. | 2355 W. Chandler Blvd. | Chandler AZ, 85224-6199

The Microchip name and logo and the Microchip logo are registered trademarks of Microchip Technology Incorporated in the U.S.A. and other countries. All other trademarks mentioned herein are property of their respective companies.

© 2020, Microchip Technology Incorporated. All Rights Reserved. 3/20

DS00002868B