

LXP-W

~40° wide beam optimized for CREE XP-E. 14.7 mm high assembly with installation tape.

SPECIFICATION:

Dimensions	Ø 21.6 mm
Height	14.7 mm
Fastening	tape
ROHS compliant	yes ⓘ



MATERIALS:

Component	Type	Material	Colour	Finish
LR1-W	Single lens	PMMA	clear	
LXP-LH1-TAPE-BLK	Holder	PC	black	
LEILA-TAPE	Tape	Acrylic foam	black	

ORDERING INFORMATION:

Component		Qty in box	MOQ	MPQ	Box weight (kg)
FA10832_LXP-W	Single lens	2304	288	144	12.1
» Box size: 470 x 235 x 270 mm					

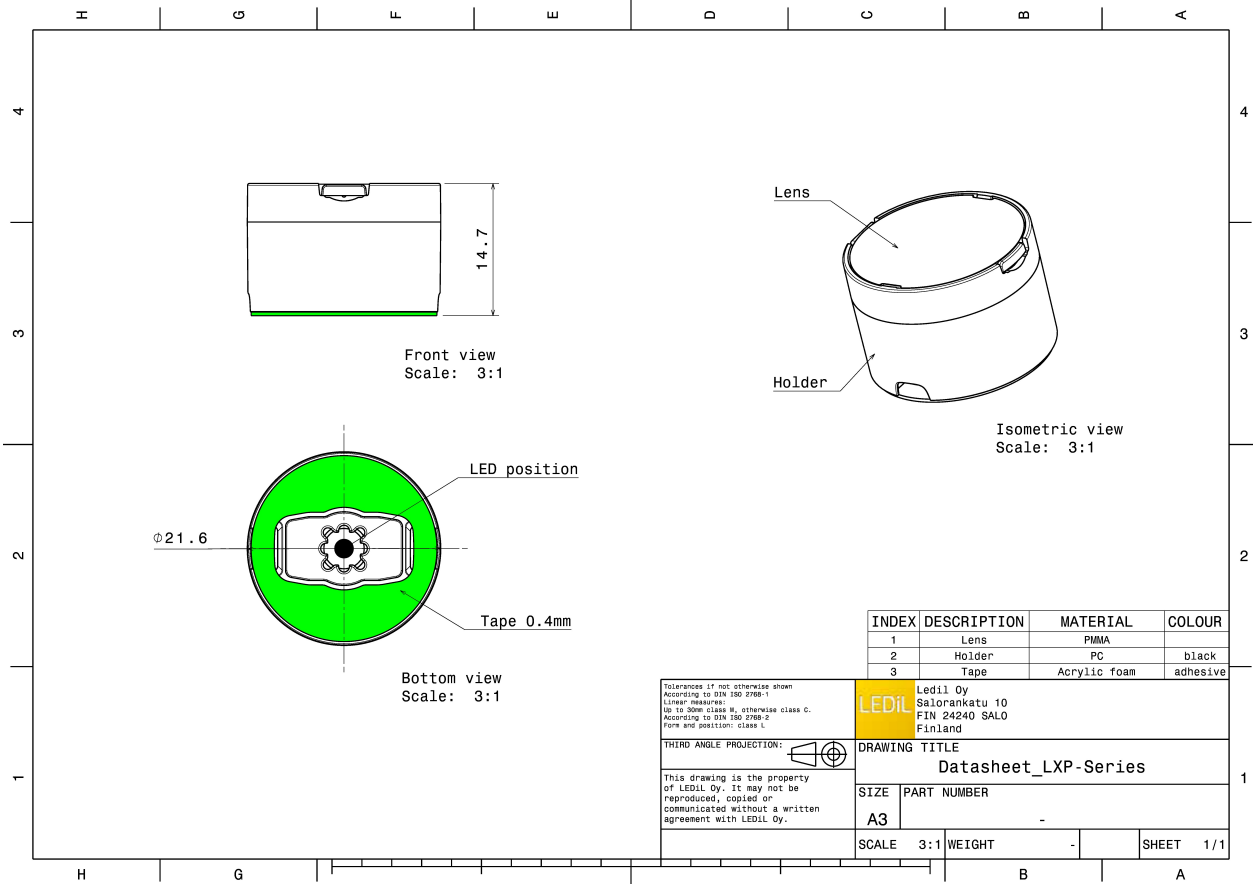

See also our general installation guide: www.ledil.com/installation_guide

OPTICAL RESULTS (MEASURED):

CREE ⇄ LED

LED XP-E
 FWHM / FWTM 44.0° / 62.0°
 Efficiency 91 %
 Peak intensity 1.8 cd/lm
 LEDs/each optic 1
 Light colour White
 Required components:

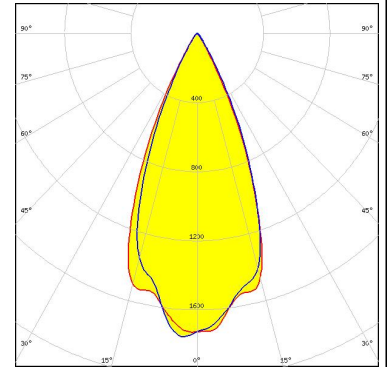

CREE ⇄ LED

LED XP-E-HEW
 FWHM / FWTM 44.0°
 Efficiency %
 LEDs/each optic 1
 Light colour White
 Required components:

CREE ⇄ LED

LED XP-G
 FWHM / FWTM 43.0° / 67.0°
 Efficiency 88 %
 Peak intensity 1.7 cd/lm
 LEDs/each optic 1
 Light colour White
 Required components:

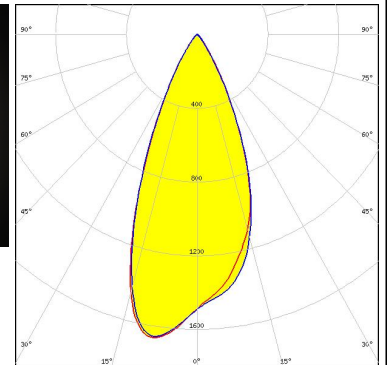
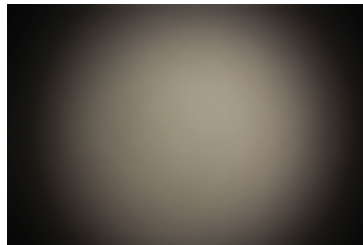

CREE ⇄ LED

LED XP-L HI
 FWHM / FWTM 45.0° / 67.0°
 Efficiency 85 %
 Peak intensity 1.5 cd/lm
 LEDs/each optic 1
 Light colour White
 Required components:

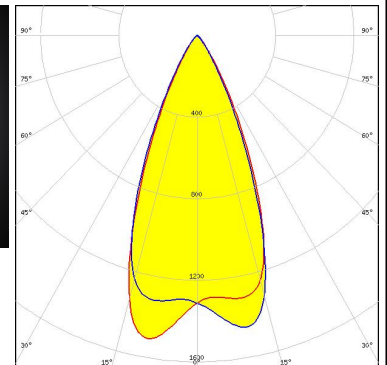
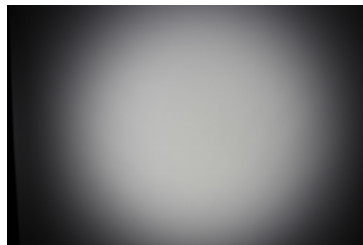

OPTICAL RESULTS (MEASURED):



LED XT-E
FWHM / FWTM 45.0°
Efficiency %
LEDs/each optic 1
Light colour White
Required components:



OSRAM
Opto Semiconductors
LED OSLON Square CSSRM2/CSSRM3
FWHM / FWTM 44.0° / 67.0°
Efficiency 88 %
Peak intensity 1.8 cd/lm
LEDs/each optic 1
Light colour White
Required components:

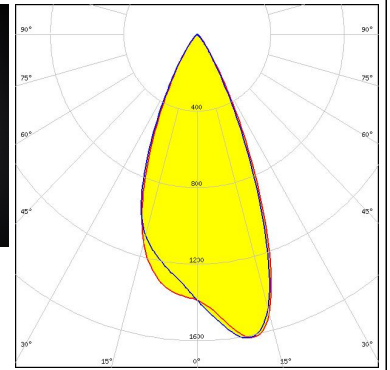
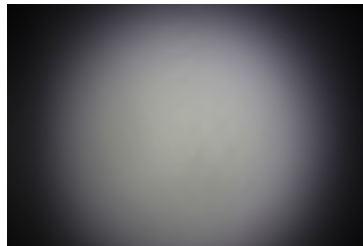

OPTICAL RESULTS (SIMULATED):



LED XP-G3
FWHM / FWTM 45.0° / 69.0°
Efficiency 87 %
Peak intensity 1.4 cd/lm
LEDs/each optic 1
Light colour White
Required components:

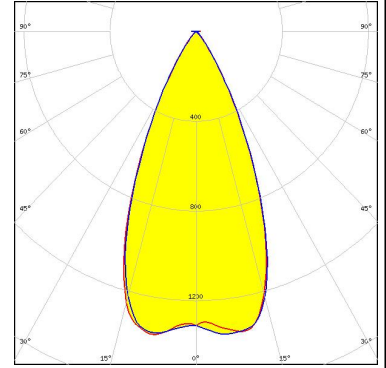

LED LUXEON V2
FWHM / FWTM 45.0° / 64.0°
Efficiency 93 %
Peak intensity 1.5 cd/lm
LEDs/each optic 1
Light colour White
Required components:

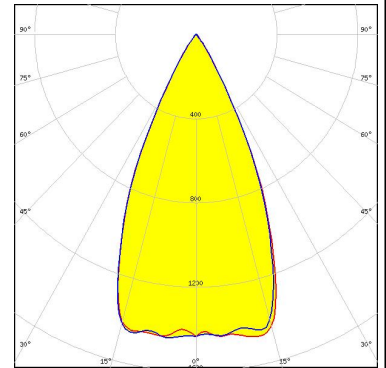

LED Z5
FWHM / FWTM 46.0° / 64.0°
Efficiency 93 %
Peak intensity 1.7 cd/lm
LEDs/each optic 1
Light colour White
Required components:

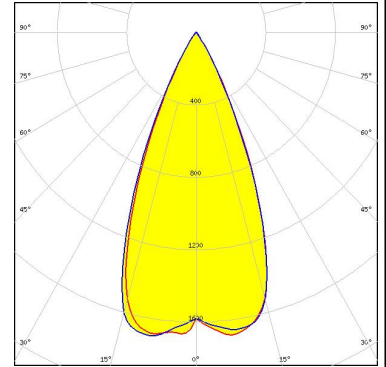

GENERAL INFORMATION:

NOTE: The typical beam angle will be changed by different color, chip size and chip position tolerance. The typical total beam angle is the full angle measured where the luminous intensity is half of the peak value.

MATERIALS:

As part of our continuous research and improvement processes, and to ensure the best possible quality and availability of our products, LEDiL reserves the right to change material grades without notice.

PRODUCT DATA USER AGREEMENT AND DISCLAIMER:

The measured data in the provided downloadable LEDiL Product Datasheets and Mechanical 2D-Drawings is rounded and provided as reference for planning. LEDiL Oy's optical specifications have been verified by conducting performance testing of the products in accordance with the company's quality system. The reported data are averaged results of multiple measurements with typical variation. LEDiL Oy reserves the right to without prior notification make changes and improvements to its products.

LEDiL Oy assumes neither warranty, nor guarantee nor any other liability of any kind for the contents and correctness of the provided data. The provided data has been generated with highest diligence but the provided data may in reality not represent the complete possible variation range of all intrinsic parameters. Therefore, in certain cases a deviation from the provided data could occur.

LEDiL Oy reserves the right to undertake technical changes of its products without further notification which could lead to changes in the provided data. LEDiL Oy assumes no liability of any kind for the possible deviation from any provided data or any other damage resulting from the usage of the provided data.

The user agrees to this disclaimer and user agreement with the download or usage of the provided files.

LEDiL Oy

Joensuunkatu 13
FI-24240 SALO
Finland

LEDiL Inc.

228 West Page Street
Suite D
Sycamore IL 60178
USA

Ledil Optics Technology (Shenzhen) Co., Ltd.

405 , Block B
Casic Motor Building
Shenzhen 518057
P.R.CHINA

Local sales and technical support

[www.ledil.com/
where_to_buy](http://www.ledil.com/where_to_buy)

Shipping locations

Salo, Finland
Hong Kong, China

Distribution Partners

[www.ledil.com/
where_to_buy](http://www.ledil.com/where_to_buy)