

P-Channel Enhancement Mode Power MOSFET

Description

The G45P02D3 uses advanced trench technology to provide excellent $R_{DS(ON)}$, low gate charge. It can be used in a wide variety of applications.

General Features

- V_{DS} -20V
- I_D (at $V_{GS} = -10V$) -45A
- $R_{DS(ON)}$ (at $V_{GS} = -4.5V$) < 9.5m Ω
- $R_{DS(ON)}$ (at $V_{GS} = -2.5V$) < 12.5m Ω
- $R_{DS(ON)}$ (at $V_{GS} = -1.8V$) < 16m Ω
- 100% Avalanche Tested
- RoHS Compliant

Application

- Power switch
- DC/DC converters

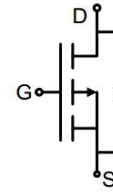

Schematic diagram

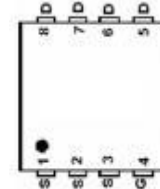

pin assignment

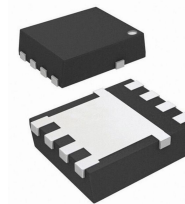

DFN3x3-8L

Ordering Information

Device	Package	Marking	Packaging
G45P02D3	DFN3x3-8L	G45P02	5000pcs/Reel

Absolute Maximum Ratings $T_C = 25^\circ\text{C}$, unless otherwise noted

Parameter	Symbol	Value	Unit
Drain-Source Voltage	V_{DS}	-20	V
Continuous Drain Current	I_D	-45	A
Pulsed Drain Current (note1)	I_{DM}	-180	A
Gate-Source Voltage	V_{GS}	± 12	V
Power Dissipation	P_D	29	W
Single pulse avalanche energy (note2)	E_{AS}	81	mJ
Operating Junction and Storage Temperature Range	T_J, T_{stg}	-55 To 150	$^\circ\text{C}$

Thermal Resistance

Parameter	Symbol	Value	Unit
Thermal Resistance, Junction-to-Ambient	R_{thJA}	75	$^\circ\text{C/W}$
Maximum Junction-to-Case	R_{thJC}	4.2	$^\circ\text{C/W}$

Specifications $T_J = 25^\circ\text{C}$, unless otherwise noted						
Parameter	Symbol	Test Conditions	Value			Unit
			Min.	Typ.	Max.	
Static Parameters						
Drain-Source Breakdown Voltage	$V_{(BR)DSS}$	$V_{GS} = 0V, I_D = -250\mu A$	-20	--	--	V
Zero Gate Voltage Drain Current	I_{DSS}	$V_{DS} = -20V, V_{GS} = 0V$	--	--	-1	μA
Gate-Source Leakage	I_{GSS}	$V_{GS} = \pm 12V$	--	--	± 100	nA
Gate-Source Threshold Voltage	$V_{GS(th)}$	$V_{DS} = V_{GS}, I_D = -250\mu A$	-0.4	-0.65	-1	V
Drain-Source On-Resistance	$R_{DS(on)}$	$V_{GS} = -4.5V, I_D = -10A$	--	6	9.5	m Ω
		$V_{GS} = -2.5V, I_D = -20A$	--	8	12.5	
		$V_{GS} = -1.8V, I_D = -20A$	--	11	16	
Forward Transconductance	g_{FS}	$V_{DS} = -5V, I_D = -10A$	--	72	--	S
Dynamic Parameters						
Input Capacitance	C_{iss}	$V_{GS} = 0V,$ $V_{DS} = -10V,$ $f = 1.0MHz$	--	4867	--	pF
Output Capacitance	C_{oss}		--	642	--	
Reverse Transfer Capacitance	C_{rss}		--	593	--	
Total Gate Charge	Q_g	$V_{DD} = -10V,$ $I_D = -20A,$ $V_{GS} = -10V$	--	44	--	nC
Gate-Source Charge	Q_{gs}		--	9	--	
Gate-Drain Charge	Q_{gd}		--	11	--	
Turn-on Delay Time	$t_{d(on)}$	$V_{DD} = -10V,$ $I_D = -20A,$ $R_G = 3\Omega$	--	18	--	ns
Turn-on Rise Time	t_r		--	32	--	
Turn-off Delay Time	$t_{d(off)}$		--	136	--	
Turn-off Fall Time	t_f		--	59	--	
Drain-Source Body Diode Characteristics						
Continuous Body Diode Current	I_S	$T_C = 25^\circ\text{C}$	--	--	-45	A
Body Diode Voltage	V_{SD}	$T_J = 25^\circ\text{C}, I_{SD} = -10A, V_{GS} = 0V$	--	--	-1.2	V
Reverse Recovery Charge	Q_{rr}	$I_F = -10A, V_{GS} = 0V$ $di/dt = -500A/\mu s$	--	100	--	nC
Reverse Recovery Time	T_{rr}		--	33	--	ns

Notes

1. Repetitive Rating: Pulse width limited by maximum junction temperature
2. EAS condition : $T_J = 25^\circ\text{C}, V_{DD} = -20V, V_{GS} = -10V, L = 0.5mH, R_G = 25\Omega$
3. Identical low side and high side switch with identical R_G

Gate Charge Test Circuit

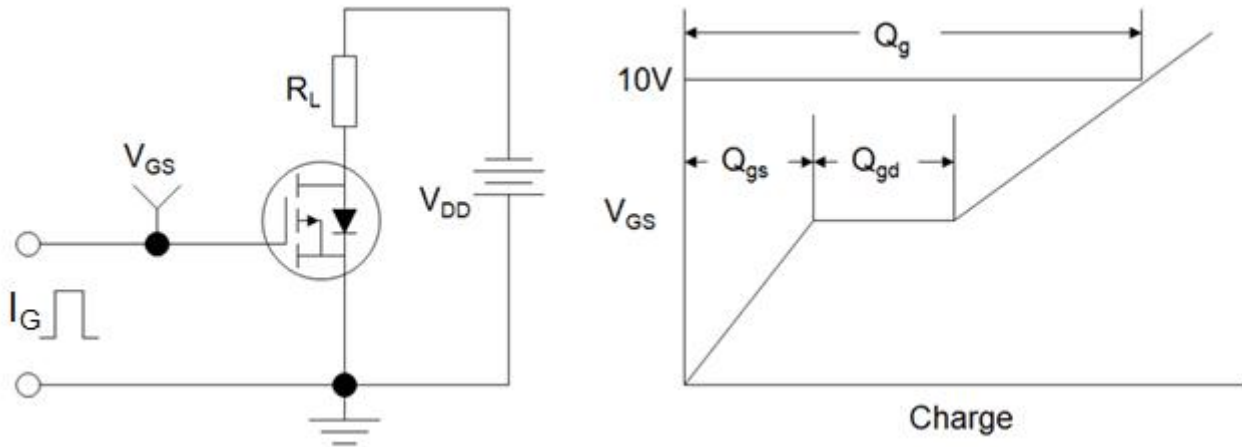

Switch Time Test Circuit



EAS Test Circuit

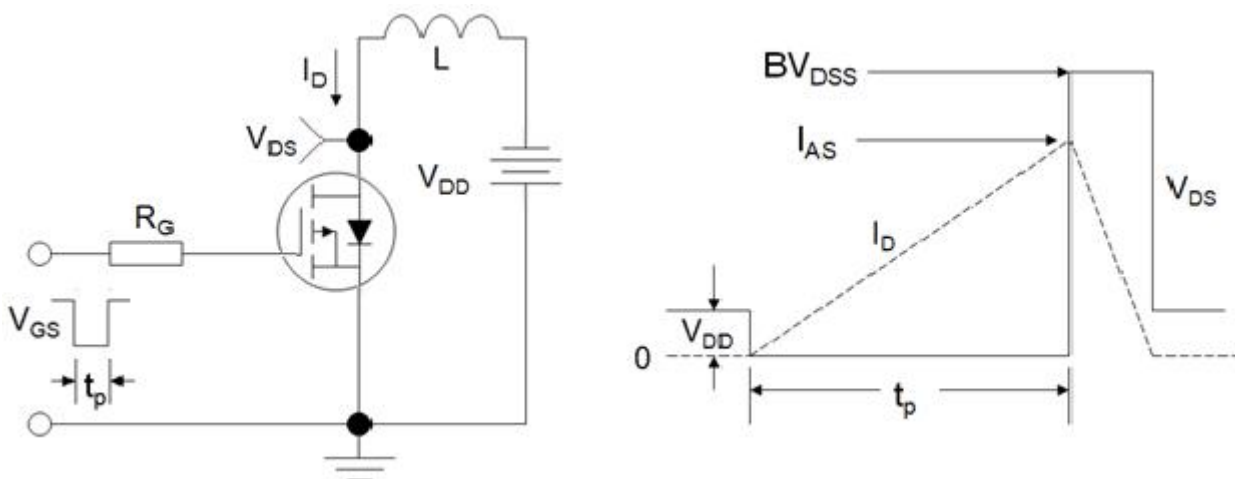

Typical Characteristics $T_J = 25^\circ\text{C}$, unless otherwise noted

Figure 1. Output Characteristics

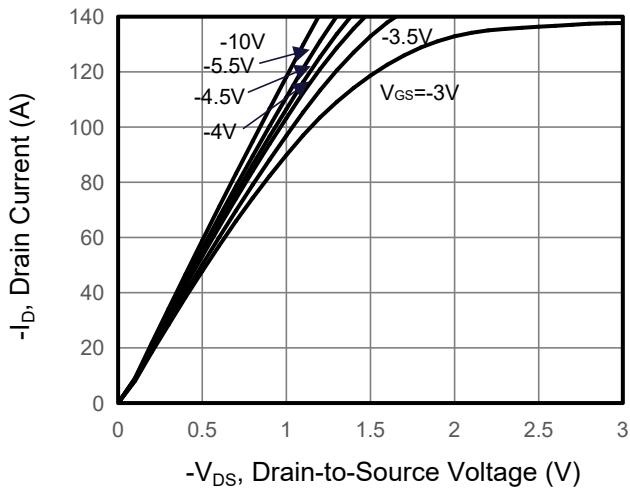

Figure 2. Transfer Characteristics

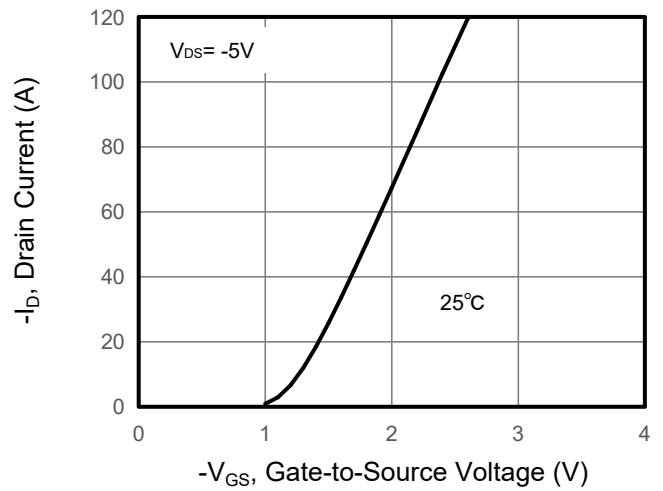

Figure 3. Drain Source On Resistance

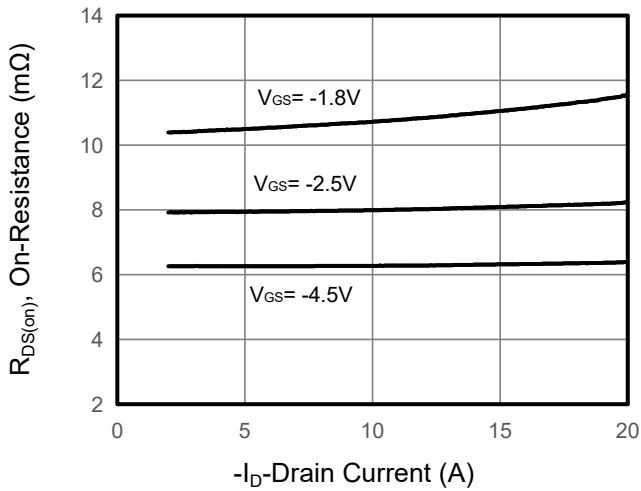

Figure 4. Gate Charge

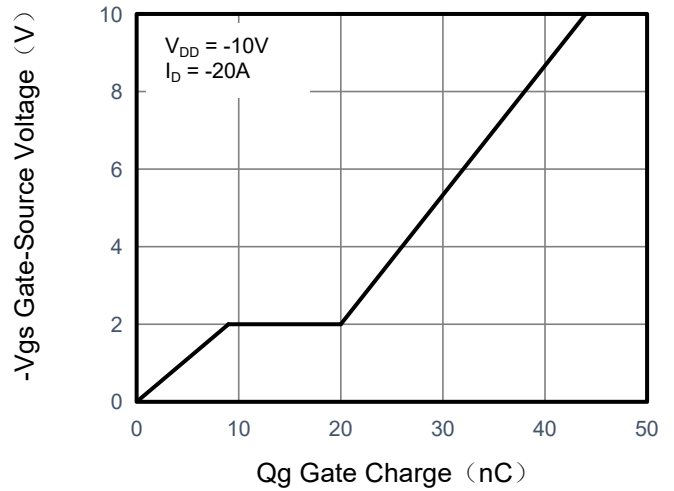

Figure 5. Capacitance

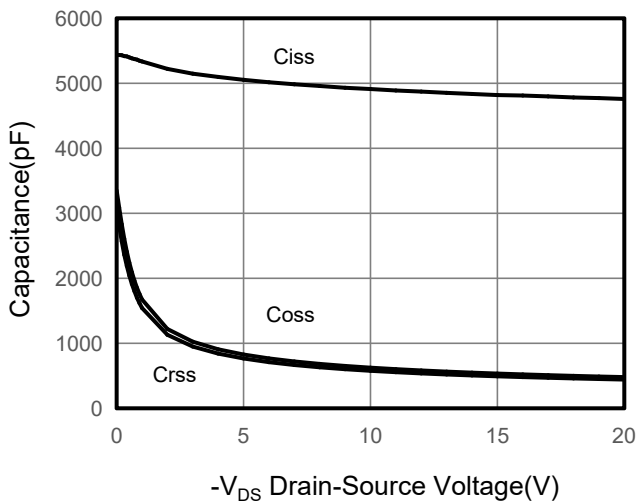
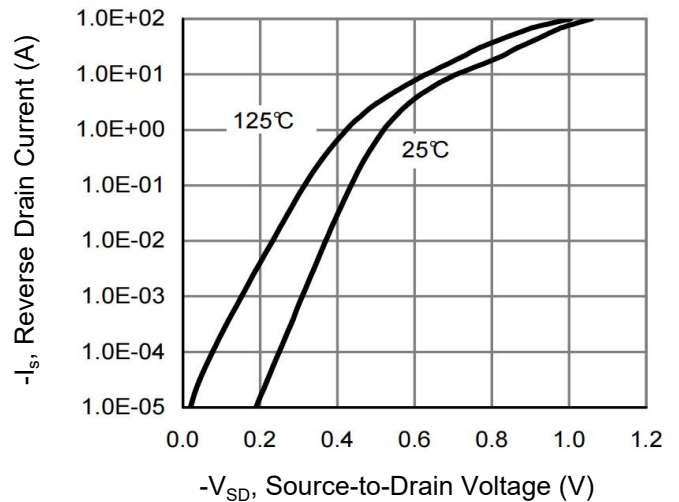

Figure 6. Source-Drain Diode Forward



Typical Characteristics $T_J = 25^\circ\text{C}$, unless otherwise noted

Figure 7. Drain-Source On-Resistance

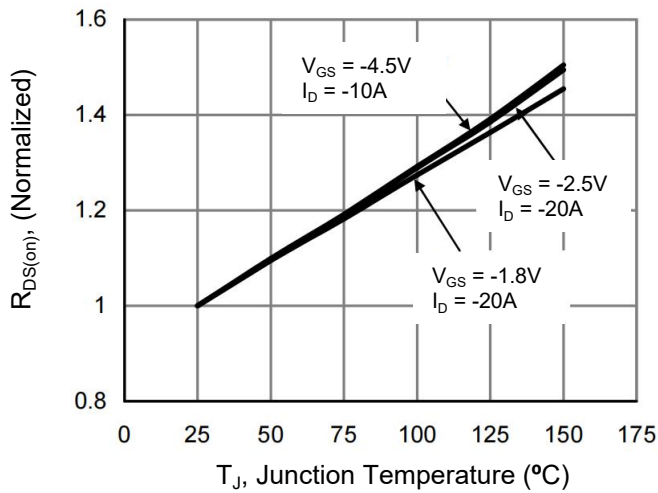

Figure 10. Safe Operation Area

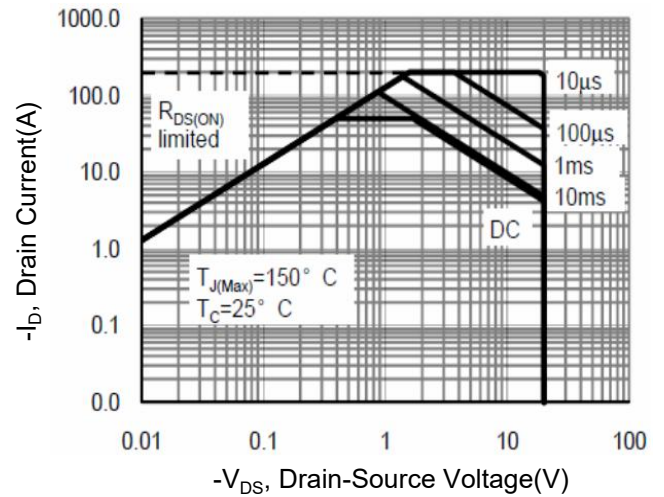
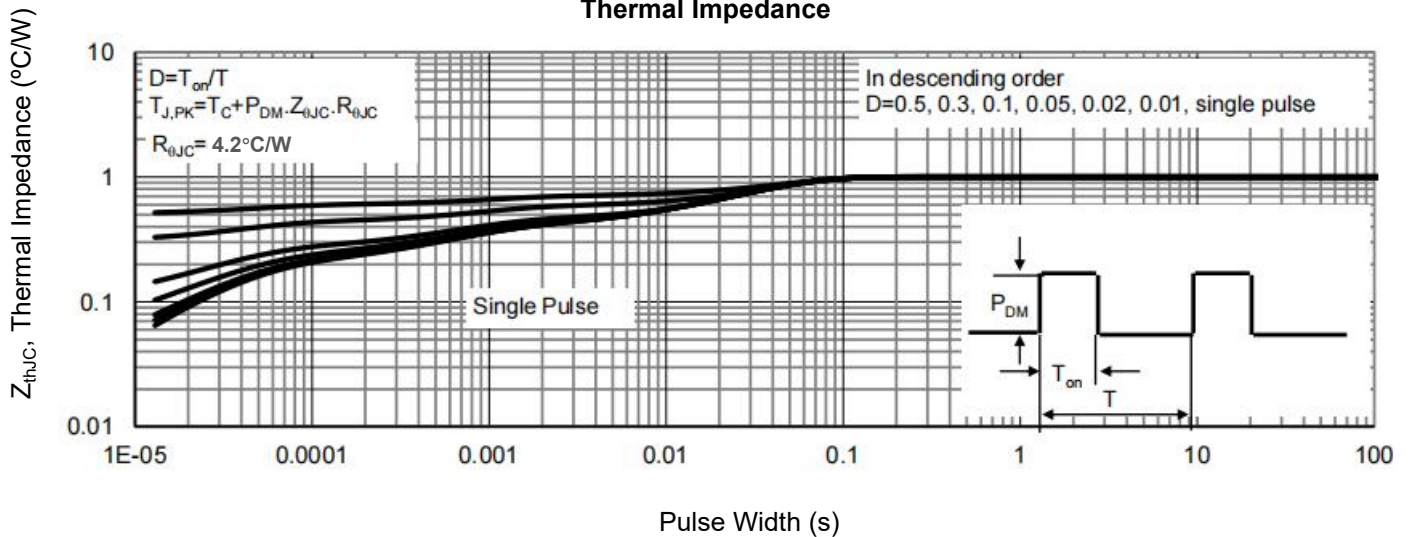
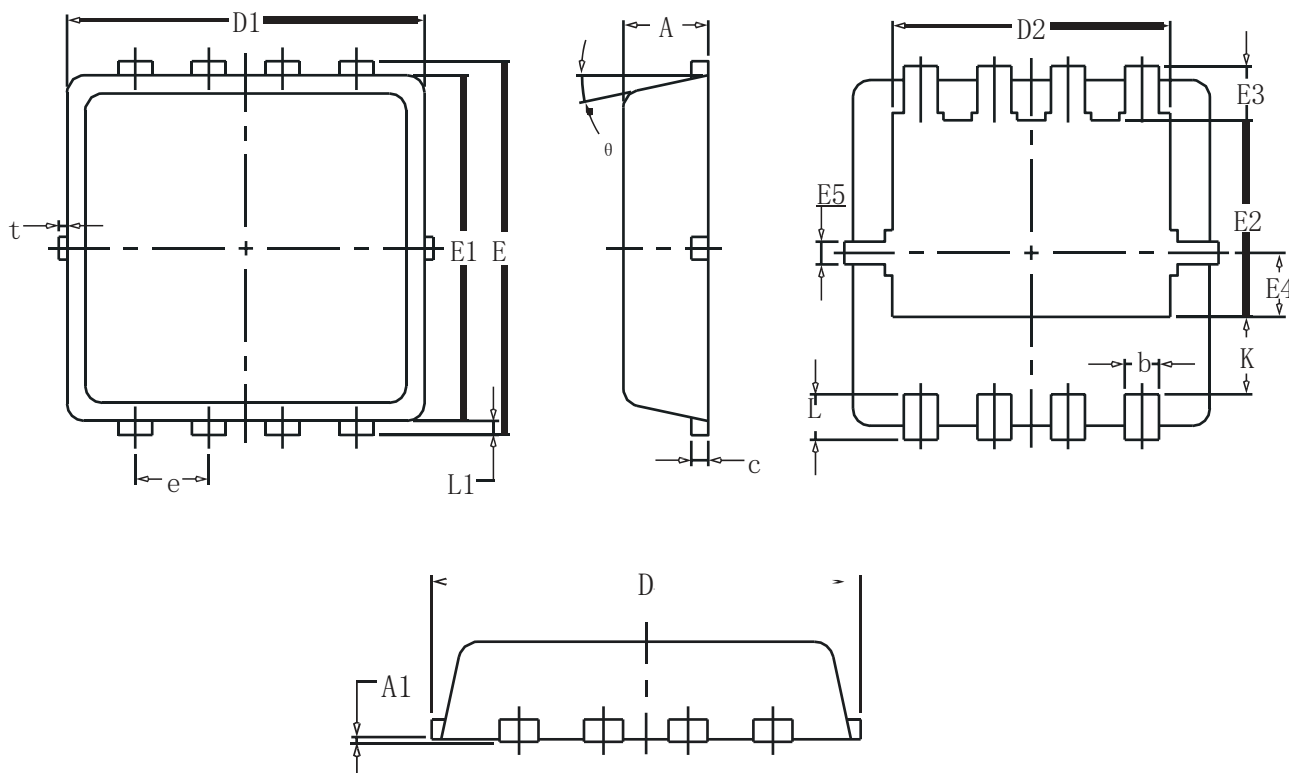

Figure 9. Normalized Maximum Transient Thermal Impedance



DFN3x3-8L Package Information



SYMBOL	COMMON		
	MM		
	MIN	NOM	MAX
A	0.70	0.75	0.85
A1	-	-	0.05
b	0.20	0.30	0.40
c	0.10	0.152	0.25
D	3.15	3.30	3.45
D1	3.00	3.15	3.25
D2	2.29	2.45	2.65
E	3.15	3.30	3.45
E1	2.90	3.05	3.20
E2	1.54	1.74	1.94
E3	0.28	0.48	0.65
E4	0.37	0.57	0.77
E5	0.10	0.20	0.30
e	0.60	0.65	0.70
K	0.59	0.69	0.89
L	0.30	0.40	0.50
L1	0.06	0.125	0.20
t	0	0.075	0.13
θ	10°	12°	14°