

# 18 CHANNELS LED DRIVER EVALUATION BOARD GUIDE

## DESCRIPTION

IS31FL3218 is comprised of 18 constant current channels each with independent PWM control, designed for driving LEDs. The output current of each channel can be set at up to 38mA (Max.) by an external resistor. The average LED current of each channel can be changed in 256 steps by changing the PWM duty cycle through an I2C interface.

The chip can be turned off by pulling the SDB pin low or by using the software shutdown feature to reduce power consumption. The slave address is fixed “1010 1000”.

## FEATURES

- 2.7V to 5.5V supply
- I2C interface, automatic address increment function
- Internal reset register
- Modulate LED brightness with 256 steps PWM
- Each channel can be controlled independently
- -40°C to +85°C temperature range
- QFN-24 (4mm × 4mm), SOP-24 packages

## QUICK START

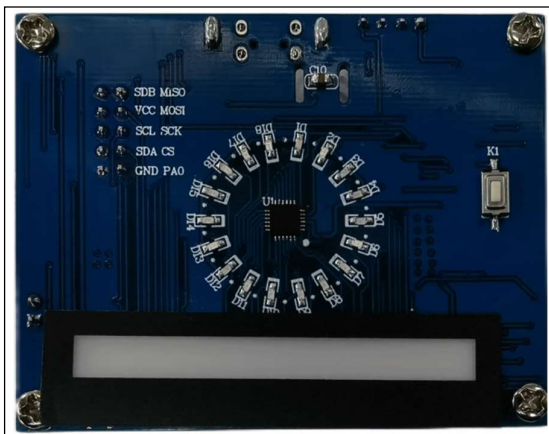

Figure 1: Photo of IS31FL3218 Evaluation Board  
(Please refer to Appendix I if MCU is LPC922)

## RECOMMENDED EQUIPMENT

- 5.0V, 2A power supply

## ABSOLUTE MAXIMUM RATINGS

- ≤ 5.5V power supply

**Caution: Do not exceed the conditions listed above, otherwise the board will be damaged.**

## PROCEDURE

The IS31FL3218 evaluation board is fully assembled and tested. Follow the steps listed below to verify board operation.

**Caution: Do not turn on the power supply until all connections are completed.**

- 1) If using external DC power supply connect the ground terminal of the power supply to the evaluation board's GND pin and the positive terminal to the VCC pin. The evaluation board can also be powered via the Micro USB connector.
- 2) Short J1 to close external control.
- 3) Turn on the power supply/Plug in the Micro USB and pay attention to the supply current. If the current exceeds 1A, please check for circuit fault.
- 4) Enter the desired mode of display by toggling the MODE button (K1).

## ORDERING INFORMATION

Part No.	Temperature Range	Package
IS31FL3218-QFLS2-EB	-40°C to +85°C (Industrial)	QFN-24, Lead-free

Table 1: Ordering Information

For pricing, delivery, and ordering information, please contacts Lumissil's analog marketing team at [analog@Lumissil.com](mailto:analog@Lumissil.com) or (408) 969-6600.

## 18 CHANNELS LED DRIVER EVALUATION BOARD GUIDE

### EVALUATION BOARD OPERATION

The IS31FL3218 evaluation board has eight display modes. Press K1 to switch configurations.

- 1) Mode1: 3 single color LEDs chase after other 3 single color LEDs
- 2) Mode2: 9 single color LEDs chase after other 9 single color LEDs
- 3) Mode3: single colors LEDs go round and round, the speed is slow and then hurries up.
- 4) Mode4: 2 single-color LEDs are a group of 6 groups, which rotate in a loop.
- 5) Mode5: 18 single color LEDs breathe.
- 6) Mode6: the color of RGB LEDs are changing and moving from RGB1 to RGB6 all the time.
- 7) Mode7: the RGB LEDs (RGB1-RGB6) are breathing, and the color is changing all the time
- 8) Mode8: the RGB LEDs (RGB1-RGB6) are changing color from two sides to middle.

**Note:** IS31FL3218 solely controls the FxLED function on the evaluation board.

### SOFTWARE SUPPORT

JP1 default setting is closed (jumper on). If it is open (when the EVB is powered on by 5V DC or micro-USB, no jumper JP1), the on-board MCU will configure its own I2C/SDB/AD pins to High Impedance status so an external source can driver the I2C/SDB signals to control the IS31FL3218 LED driver, the on-board MCU will also configure the U4 to open the VLED (Single color LED+) and close the VRGB.

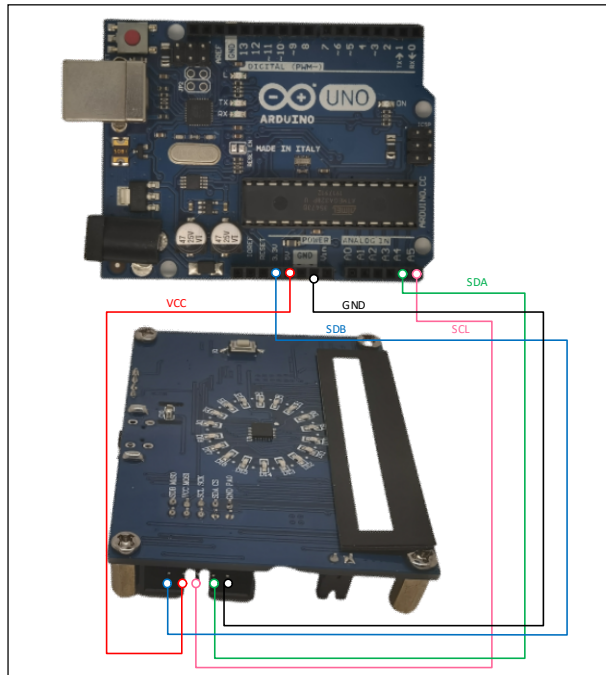

Figure 2: Photo of Arduino UNO connected to Evaluation Board

The steps listed below are an example using the Arduino for external control.

The Arduino hardware consists of an Atmel microcontroller with a bootloader allowing quick firmware updates. First download the latest Arduino Integrated Development Environment IDE (1.6.12 or greater) from [www.arduino.cc/en/Main/Software](http://www.arduino.cc/en/Main/Software). Also download the Wire.h library from [www.arduino.cc/en/reference/wire](http://www.arduino.cc/en/reference/wire) and verify that pgmspace.h is in the directory ...program Files(x86)/Arduino/hardware/tools/avr/avr/include/avr/. Then download the latest IS31FL3218 test firmware (sketch) from the Lumissil website <http://www.lumissil.com/products/led-driver/fxled>.

- 1) Keep the JP1 shorted.
- 2) Power on the Arduino UNO.
- 3) Connect the 2 pins from Arduino board to IS31FL3218 EVB:
  - a) Arduino GND to IS31FL3218 EVB GND (TP4).
  - b) Arduino 5V pin to IS31FL3218 EVB VCC (TP4).

The on-board MCU will start to run in default mode (Mode1).

- 4) Open the JP1, the on-board configure the SDA/SCL/SDB to Hi-Z status, all LEDs are turned off.
- 5) Connect the 3 pins from Arduino board to IS31FL3218 EVB:
  - a) Arduino SDA (A4) to IS31FL3218 EVB SDA (TP4).
  - b) Arduino SCL (A5) to IS31FL3218 EVB SCL (TP4).
  - c) If Arduino use 3.3V MCU VCC, connect 3.3V to IS31FL3218 EVB SDB, if Arduino use 5.0V MCU VCC, connect 5.0V to EVB SDB (TP4).
  - d) (Arduino UNO is 5.0V, so SDB=5.0V)
- 6) Use the test code in appendix I or download the test firmware (sketch) from the Lumissil website, a .txt file and copy the code to Arduino IDE, compile and upload to Arduino.
- 7) Run the Arduino code and the single LED will run the Arduino code. If need to swap to RGB display, one way is de-soldering the U4 and short the U4's pin 3 and pin 5 or pin 6 to enable the power of RGB.

**Please refer to the datasheet to get more information about IS31FL3218.**

# 18 CHANNELS LED DRIVER EVALUATION BOARD GUIDE

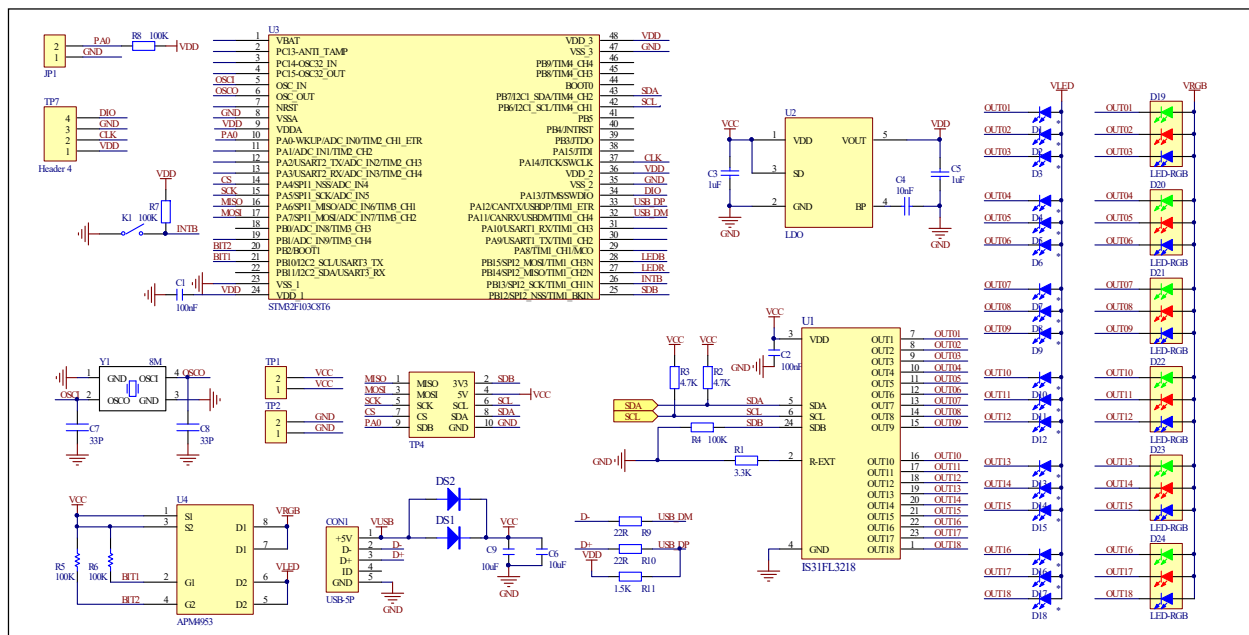

Figure 3: IS31FL3218 Application Schematic

# 18 CHANNELS LED DRIVER EVALUATION BOARD GUIDE

## BILL OF MATERIALS

Name	Symbol	Description	Qty	Supplier	Part No.
LED Driver	U1	18CH FxLED Driver	1	Lumissil	IS31FL3218
LDO	U2	3.0V LDO	1	SGMICRO	SGM2019-3.0YN5G
MCU	U3	Microcontroller	1	STM	STM32F103C8T6
PMOS	U4	PMOS	1	ANPEC	APM4953
Diode	DS1, DS2	Diode, SMD	2	DIODES	DFLS240
Diode	D1~D18	Diode, LED Blue, SMD	18	Everlight	19-217/BHC-ZL1M2RY/3T
Diode	D19~D24	Diode, LED RGB, SMD	6	Everlight	99-235/RSGBB7C-A22/2D or 99-235/RGBC/TR8
Resistor	R1	RES,3.3k,1/10W,±5%,SMD	1	Yageo	RC0603JR-0733KL
Resistor	R2, R3	RES,4.7k,1/10W,±5%,SMD	2	Yageo	RC0603JR-0747KL
Resistor	R4,R5,R6, R7,R8	RES,100k,1/10W,±5%,SMD	5	Yageo	RC0603JR-07100KL
Resistor	R9, R10	RES,22R,1/10W,±5%,SMD	2	Yageo	RC0603JR-0722RL
Resistor	R11	RES,1.5k,1/10W,±5%,SMD	1	Yageo	RC0603JR-071K5L
Capacitor	C1, C2	CAP,100nF,16V,±20%,SMD	2	Yageo	CC0603MRX7R7BB104
Capacitor	C3, C5	CAP,1µF,16V,±10%,SMD	2	Yageo	CC0603KRX7R7BB105
Capacitor	C4	CAP,10nF,16V,±10%,SMD	1	Yageo	CC0603KPX7R7BB103
Capacitor	C7, C8	CAP,33pF,50V,±1%,SMD	2	Yageo	AC0603FRNPO9BN330
Capacitor	C6, C9	CAP, 10µF,16V,±10%,SMD	2	Yageo	CC0805KKX7R7BB106
Button	K1	Button SMD	1		
Crystal	Y1	Crystal, 8MHz	1	JB	HC-49S

*Bill of Materials, refer to Figure 3 above.*

# 18 CHANNELS LED DRIVER EVALUATION BOARD GUIDE

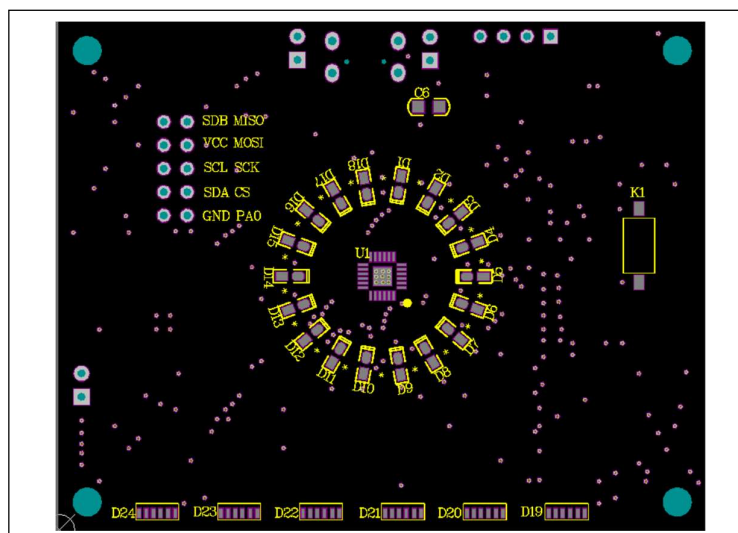

Figure 4: Board Component Placement Guide - Top Layer

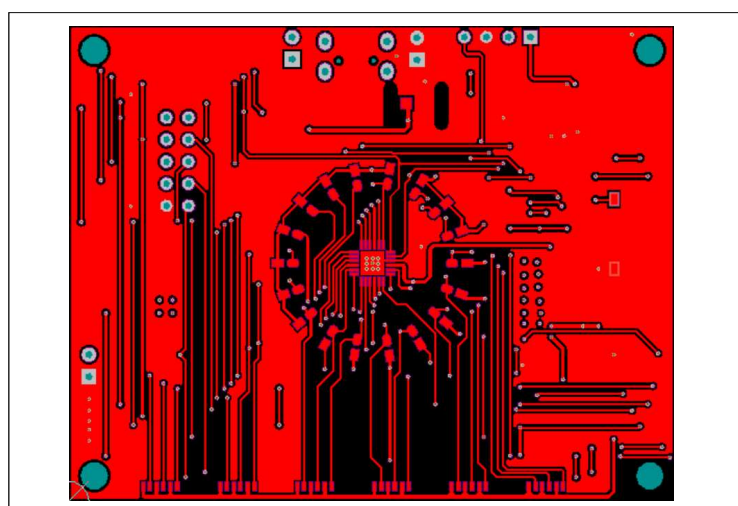
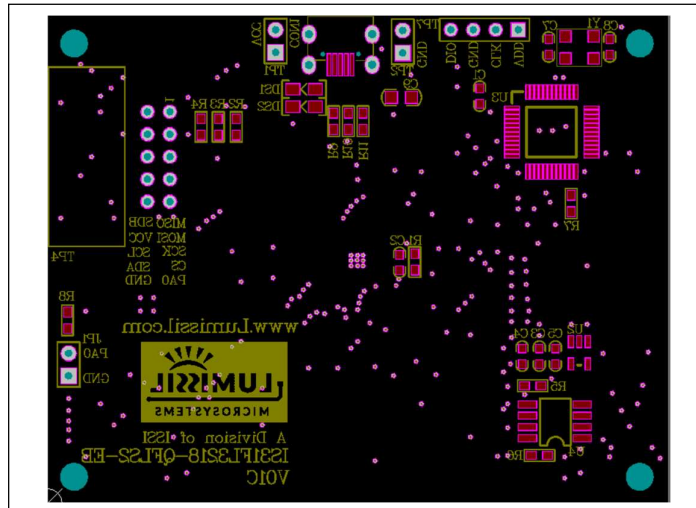
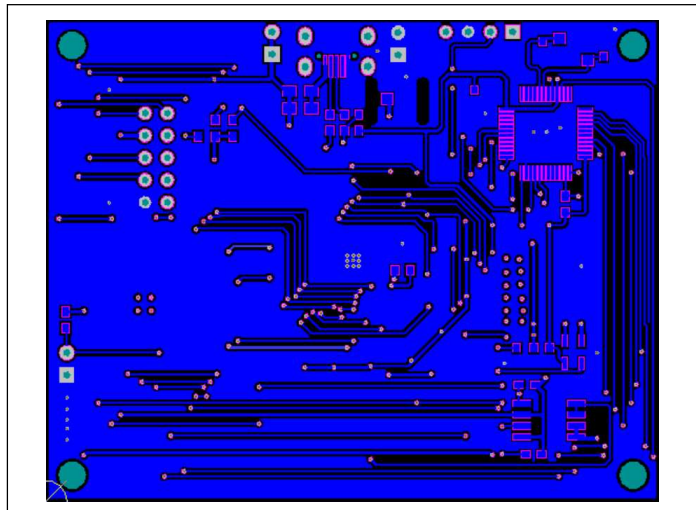

Figure 5: Board PCB Layout - Top Layer

# 18 CHANNELS LED DRIVER EVALUATION BOARD GUIDE



**Figure 6: Board Component Placement Guide - Bottom Layer**



**Figure 7: Board PCB Layout - Bottom Layer**

Copyright © 2021 Lumissil Microsystems. All rights reserved. Lumissil Microsystems reserves the right to make changes to this specification and its products at any time without notice. Lumissil Microsystems assumes no liability arising out of the application or use of any information, products or services described herein. Customers are advised to obtain the latest version of this device specification before relying on any published information and before placing orders for products.

Lumissil Microsystems does not recommend the use of any of its products in life support applications where the failure or malfunction of the product can reasonably be expected to cause failure of the life support system or to significantly affect its safety or effectiveness. Products are not authorized for use in such applications unless Lumissil Microsystems receives written assurance to its satisfaction, that:

- a.) the risk of injury or damage has been minimized;
- b.) the user assume all such risks; and
- c.) potential liability of Lumissil Microsystems is adequately protected under the circumstances

## 18 CHANNELS LED DRIVER EVALUATION BOARD GUIDE

---

### REVISION HISTORY

---

Revision	Detail Information	Data
A	Initial Release	2018.04.03
B	Update the BOM	2021.05.08
C	Update the BOM, update to new MCU, Update schematic and PCB layout	2021.12.10



# 18 CHANNELS LED DRIVER EVALUATION BOARD GUIDE

## APPENDIX I : Rev. B Guide

### DESCRIPTION

IS31FL3218 is comprised of 18 constant current channels each with independent PWM control, designed for driving LEDs. The output current of each channel can be set at up to 38mA (Max.) by an external resistor. The average LED current of each channel can be changed in 256 steps by changing the PWM duty cycle through an I2C interface.

The chip can be turned off by pulling the SDB pin low or by using the software shutdown feature to reduce power consumption. The slave address is fixed “1010 1000”.

### FEATURES

- 2.7V to 5.5V supply
- I2C interface, automatic address increment function
- Internal reset register
- Modulate LED brightness with 256 steps PWM
- Each channel can be controlled independently
- -40°C to +85°C temperature range
- QFN-24 (4mm × 4mm), SOP-24 packages

### QUICK START

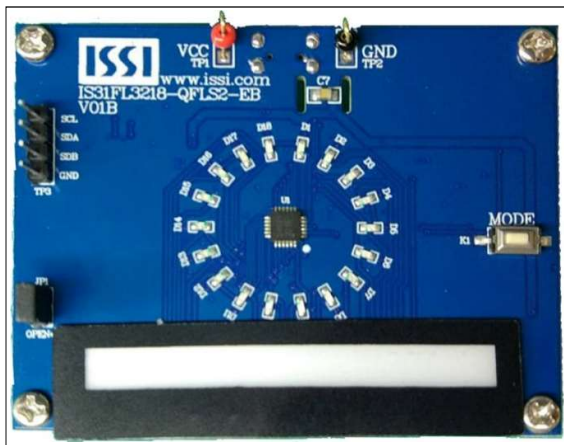

Figure 8: Photo of IS31FL3218 Evaluation Board (LPC922 Version)

### RECOMMENDED EQUIPMENT

- 5.0V, 2A power supply

### ABSOLUTE MAXIMUM RATINGS

- ≤ 5.5V power supply

**Caution: Do not exceed the conditions listed above, otherwise the board will be damaged.**

### PROCEDURE

The IS31FL3218 evaluation board is fully assembled and tested. Follow the steps listed below to verify board operation.

**Caution: Do not turn on the power supply until all connections are completed.**

- 1) If using external DC power supply connect the ground terminal of the power supply to the evaluation board's GND pin and the positive terminal to the VCC pin. The evaluation board can also be powered via the Micro USB connector.
- 2) Short J1 to close external control.
- 3) Turn on the power supply/Plug in the Micro USB and pay attention to the supply current. If the current exceeds 1A, please check for circuit fault.
- 4) Enter the desired mode of display by toggling the MODE button (K1).

### ORDERING INFORMATION

Part No.	Temperature Range	Package
IS31FL3218-QFLS2-EB	-40°C to +85°C (Industrial)	QFN-24, Lead-free

Table 1: Ordering Information

For pricing, delivery, and ordering information, please contact Lumissil's analog marketing team at [analog@Lumissil.com](mailto:analog@Lumissil.com) or (408) 969-6600.



## 18 CHANNELS LED DRIVER EVALUATION BOARD GUIDE

### EVALUATION BOARD OPERATION

The evaluation board is controlled by LPC922. IS31FL3218 evaluation board has 8 modes:

- 1) Mode1: 3 single color LEDs chase after other 3 single color LEDs
- 2) Mode2: 9 single color LEDs chase after other 9 single color LEDs
- 3) Mode3: single colors LEDs go round and round, the speed is slow and then hurries up.
- 4) Mode4: 3 groups single color LEDs on two sides circumrotated.
- 5) Mode5: 18 single color LEDs breathe.
- 6) Mode6: the color of RGB LEDs are changing and moving from RGB1 to RGB6 all the time.
- 7) Mode7: the RGB LEDs (RGB1-RGB6) are breathing, and the color is changing all the time
- 8) Mode8: the RGB LEDs (RGB1-RGB6) are changing color from two sides to middle.

**Note:** IS31FL3218 solely controls the FxLED function on the evaluation board.

### SOFTWARE SUPPORT

JP1 default setting is closed (jumper on). If it is open (when the EVB is powered on by 5V DC or micro-USB, no jumper JP1), the on-board MCU will configure its own I2C/SDB/AD pins to High Impedance status so an external source can driver the I2C/SDB signals to control the IS31FL3218 LED driver, the on-board MCU will also configure the U4 to open the VLED (Single color LED+) and close the VRGB.

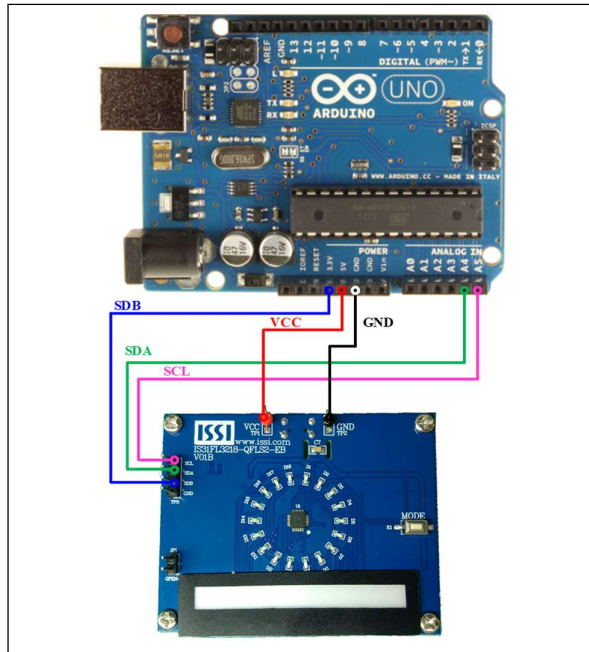

Figure 9: Photo of Arduino UNO connected to Evaluation Board

The steps listed below are an example using the Arduino for external control.

The Arduino hardware consists of an Atmel microcontroller with a bootloader allowing quick firmware updates. First download the latest Arduino Integrated Development Environment IDE (1.6.12 or greater) from [www.arduino.cc/en/Main/Software](http://www.arduino.cc/en/Main/Software). Also download the Wire.h library from [www.arduino.cc/en/reference/wire](http://www.arduino.cc/en/reference/wire) and verify that pgmspace.h is in the directory ...program Files(x86)/Arduino/hardware/tools/avr/avr/include/avr/. Then download the latest IS31FL3218 test firmware (sketch) from the Lumissil website <http://www.lumissil.com/products/led-driver/fxled>.

- 1) Keep the JP1 shorted.
- 2) Power on the Arduino UNO.
- 3) Connect the 2 pins from Arduino board to IS31FL3218 EVB:
  - c) Arduino GND to IS31FL3218 EVB GND (TP1).
  - d) Arduino 5V pin to IS31FL3218 EVB VCC (TP2).

The on-board MCU will start to run in default mode (Mode1).

- 4) Open the JP1, the on-board configure the SDA/SCL/SDB to Hi-Z status, all LEDs are turned off.
- 5) Connect the 3 pins from Arduino board to IS31FL3218 EVB:
  - a) Arduino SDA (A4) to IS31FL3218 EVB SDA (TP3).
  - b) Arduino SCL (A5) to IS31FL3218 EVB SCL (TP3).
  - c) If Arduino use 3.3V MCU VCC, connect 3.3V to IS31FL3218 EVB SDB, if Arduino use 5.0V MCU VCC, connect 5.0V to EVB SDB (TP3).  
(Arduino UNO is 5.0V, so SDB=5.0V)
- 6) Use the test code in appendix I or download the test firmware (sketch) from the Lumissil website, a .txt file and copy the code to Arduino IDE, compile and upload to Arduino.
- 7) Run the Arduino code and the single LED will run the Arduino code. If need to swap to RGB display, one way is de-soldering the U4 and short the U4's pin 3 and pin 5 or pin 6 to enable the power of RGB.

**Please refer to the datasheet to get more information about IS31FL3218.**

# 18 CHANNELS LED DRIVER EVALUATION BOARD GUIDE

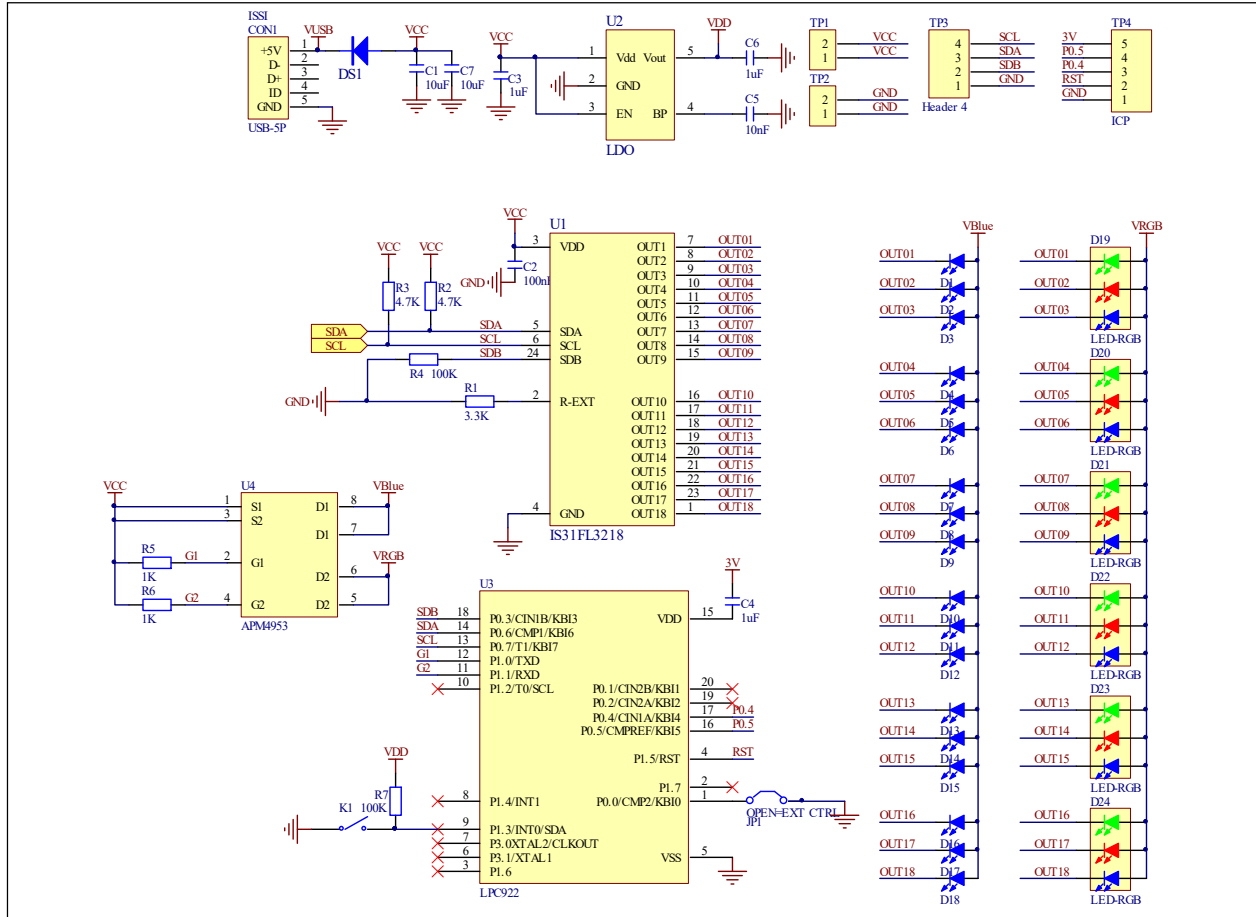

Figure 10: IS31FL3218 Application Schematic

# 18 CHANNELS LED DRIVER EVALUATION BOARD GUIDE

## BILL OF MATERIALS

Name	Symbol	Description	Qty	Supplier	Part No.
LED Driver	U1	18CH FxLED Driver	1	Lumissil	IS31FL3218
LDO	U3	3.0V LDO	1	SGMICRO	SGM2019-3.0YN5G
MCU	U3	Microcontroller	1	NXP	LPC922
PMOS	U4	PMOS	2	ANPEC	APM4953
Diode	DS1	Diode, SMD	1	DIODES	DFLS240
Diode	D1~D18	Diode, LED Blue, SMD	18	Everlight	19-217/BHC-ZL1M2RY/3T
Diode	D19~D24	Diode, LED RGB, SMD	6	Everlight	99-235/RSGBB7C-A22/2D
Resistor	R1	RES,3.3k,1/16W,±5%,SMD	1	Yageo	RC0603JR-073K3KL
Resistor	R2, R3	RES,4.7k,1/16W,±5%,SMD	2	Yageo	RC0603JR-074K7L
Resistor	R4, R7	RES,100k,1/16W,±5%,SMD	2	Yageo	RC0603JR-07100KL
Resistor	R5, R6,	RES,1k,1/16W,±5%,SMD	2	Yageo	RC0603JR-071KL
Capacitor	C1, C7	CAP,10µF,16V,±20%,SMD	2	Yageo	CC0603KKX7R9BB106
Capacitor	C2	CAP,100nF,16V,±20%,SMD	1	Yageo	CC0603KKX7R9BB104
Capacitor	C3, C4	CAP,1µF,16V,±20%,SMD	2	Yageo	CC0603KKX7R9BB105
Capacitor	C5	CAP, 10nF,16V,±20%,SMD	1	Yageo	CC0603KKX7R9BB103
Button	K1	Button SMD	1		

*Bill of Materials, refer to Figure 3 above.*

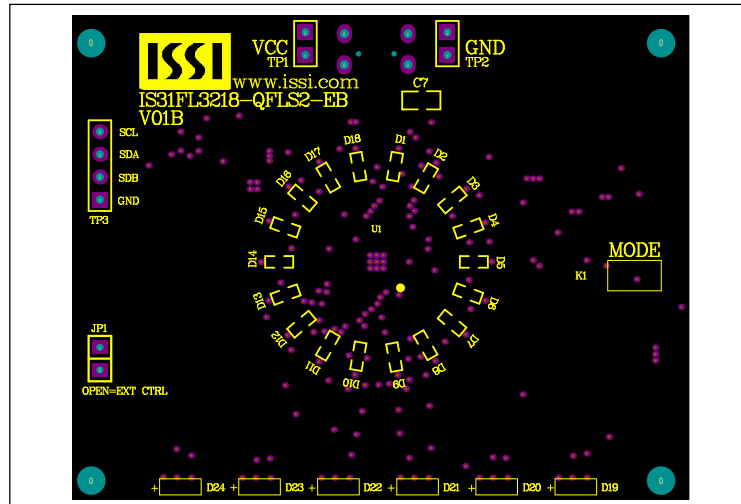

**Figure 11: Board Component Placement Guide - Top Layer**

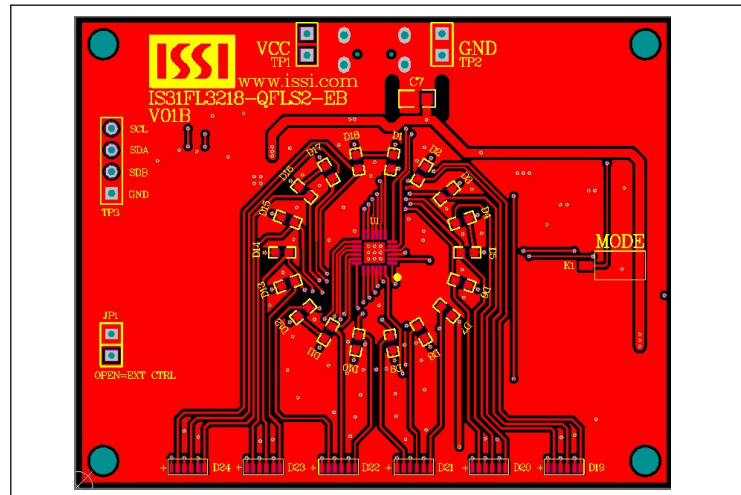

**Figure 12: Board PCB Layout - Top Layer**

# 18 CHANNELS LED DRIVER EVALUATION BOARD GUIDE

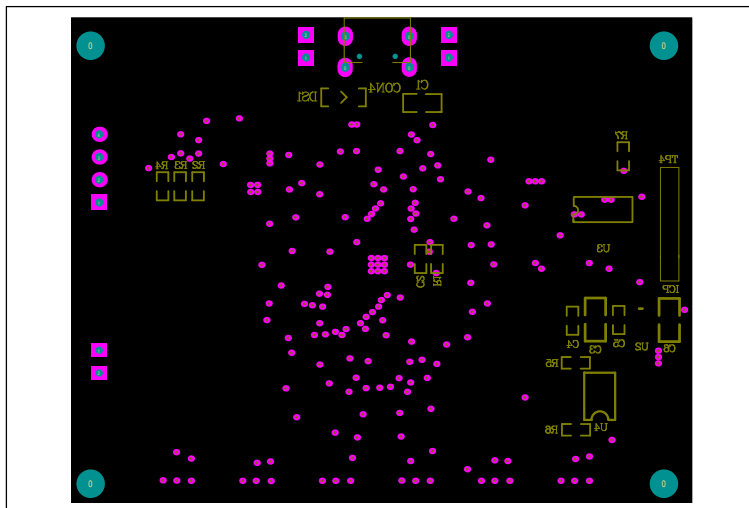

Figure 13: Board Component Placement Guide - Bottom Layer

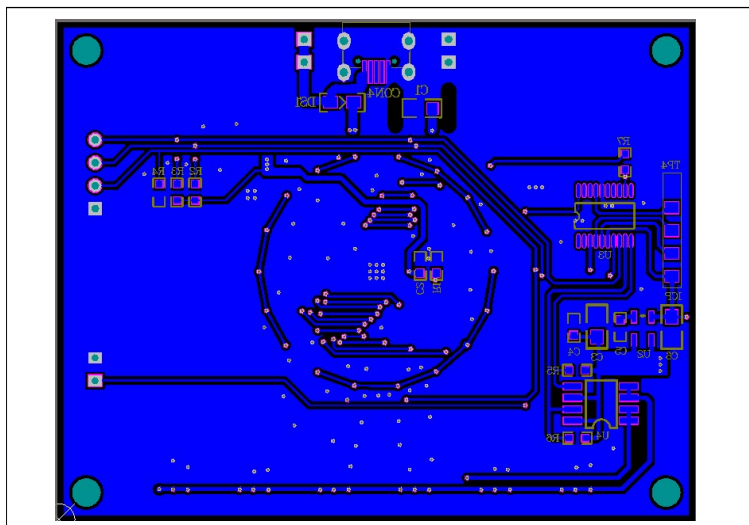

Figure 14: Board PCB Layout - Bottom Layer

## 18 CHANNELS LED DRIVER EVALUATION BOARD GUIDE

### APPENDIX II: IS31FL3218 Arduino Test Code V01A

```

#include<Wire.h>
#include<avr/pgmspace.h>
#define Addr_GND 0xA8
#define u8 unsigned char
unsigned char abm_tab[64] =           //64 step auto to breath
{
    0,1,2,3,4,5,6,7,
    8,10,12,14,16,18,20,22,
    24,26,29,32,35,38,41,44,
    47,50,53,57,61,65,69,73,
    77,81,85,89,94,99,104,109,
    114,119,124,129,134,140,146,152,
    158,164,170,176,182,188,195,202,
    209,216,223,230,237,244,251,255
};
void setup() {
    // put your setup code here, to run once:
    pinMode(13, OUTPUT);//ARDUINO BOARD LED control
    Wire.begin();
    Wire.setClock(400000);//I2C 400kHz
}
void loop()
{
    // put your main code here, to run repeatedly:
    mainloop();
}
void IS_IIC_WriteByte(uint8_t Dev_Add,uint8_t Reg_Add,uint8_t Reg_Dat) //writing an LED register
{
    Wire.beginTransmission(Dev_Add/2);
    Wire.write(Reg_Add);           // sends regaddress
    Wire.write(Reg_Dat);          // sends regaddress
    Wire.endTransmission();       // stop transmitting
}
void init_3218()
{
    u8 i;
    IS_IIC_WriteByte(Addr_GND,0x13,0xFF); //LED CTROL REGISTER
    IS_IIC_WriteByte(Addr_GND,0x14,0xFF);
    IS_IIC_WriteByte(Addr_GND,0x15,0xFF);
    for(i = 0x01;i <= 0x12;i++)
    {
        IS_IIC_WriteByte(Addr_GND,i,0x00); //ALL LED CTROL(Init pwm register)
    }
    IS_IIC_WriteByte(Addr_GND,0x16,0x00); //UP DATA TO REGISTER
}

```

## 18 CHANNELS LED DRIVER EVALUATION BOARD GUIDE

```

IS_IIC_WriteByte(Addr_GND,0x00,0x01); //CONFIGURES REGISTER to make Enable
}
/**This mainLOOP is Automatic breathing Display.***/
void mainloop()
{
  u8 i,j; //Define variables
  init_3218(); //3218 Init
  //the cycle is begining from abm_tan[63]
  i = 64;
  while(i)
  {
    for(j = 1;j <= 0x12;j++) //the loop is write value to pwm register address
    {
      IS_IIC_WriteByte(Addr_GND,j,abm_tab[i-1]); //write pwm value of Automatic breathing
    }
    IS_IIC_WriteByte(Addr_GND,0x16,0x00); //updata pwm value to pwm register
    i--; //i minus 1
    delay(10); //delay 10ms
  }
  //the cycle is begining from abm_tan[0]
  i = 1;
  while(i != 64)
  {
    for(j = 1;j <= 0x12;j++) //the loop is write value to pwm register address
    {
      IS_IIC_WriteByte(Addr_GND,j,abm_tab[i]); //write pwm value of Automatic breathing
    }
    IS_IIC_WriteByte(Addr_GND,0x16,0x00); //updata pwm value to pwm register
    i++; //i plus 1
    delay(10); //delay 10ms
  }
}

```