

NOTES:

1. Material : Spring Steel
2. Finish : Glod Irridite
3. Ends : Closed
4. Total Coils : 10.000
5. Sugg. Max. Deflection : 0.370 (in)
6. Sugg. Max. Load : 2.300 (lbs)
7. All Drawing Dimensions are in Inches [mm]

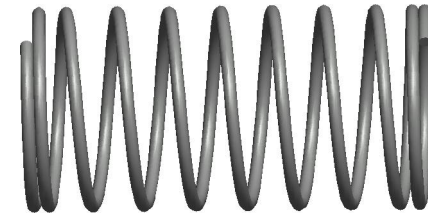

∅ 0.030
[0,76]
WIRE DIA

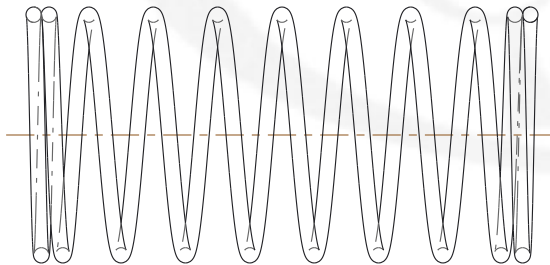

1.910
[48,51]
LENGTH

∅ 0.500
[12,70]
O.D

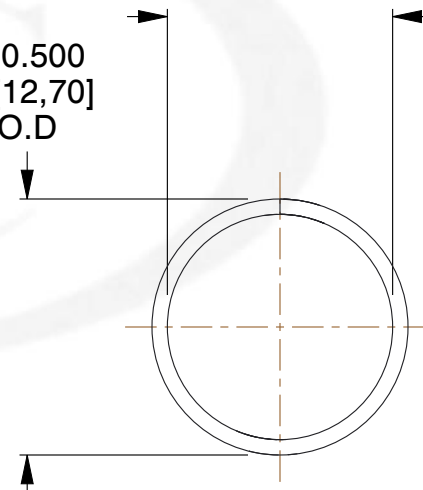

∅ 0.440
[11,18]
I.D

COMPONENT		SPRINGS	
<p>11772</p> <p>COMPRESSION SPRINGS</p>		UNIT	
		INCH [mm]	
		SHEET	
		1 of 1	



info@centuryspring.com 800.237.5225

This file and any associated information and specifications are provided for reference and evaluation purposes only, and is subject to change without notice. Century Spring makes no representations, warranties or guarantees as to the appropriateness, accuracy, completeness, or suitability for any purpose, of the file, information or specifications. You are solely responsible for the use of the file, information or specifications.

This drawing is the property of Century Spring. It contains confidential, proprietary information that is Century Spring property. Do not disclose to or duplicate for others except as authorized by Century Spring.

SCALE 2.667