

OMNIMATE Signal - series BL/SL 3.50 BL-I/O 3.50/10F SN LTGY BX

Weidmüller Interface GmbH & Co. KG
Klingenbergstraße 16
D-32758 Detmold
Germany
Fon: +49 5231 14-0
Fax: +49 5231 14-292083
www.weidmueller.com

Product image

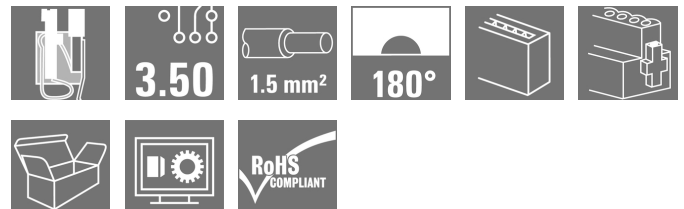

Similar to illustration

Female plugs with spring connection (PUSH IN) as a plug-in connection level for decentralised I/O electronic components; used together with male headers in a 3.50-mm pitch.

General ordering data

Type	BL-I/O 3.50/10F SN LTGY BX
Order No.	1871690000
Version	PCB plug-in connector, female plug, 3.50 mm, No. of poles: 10, 180°, PUSH IN, Tension-clamp connection, Clamping range, max.: 1.5 mm², Box
GTIN (EAN)	4032248451197
Qty.	20 pc(s).
Product data	IEC: 200 V / 2.2 A / 0.2 - 1.5 mm² UL: 50 V / 5 A / AWG 24 - AWG 16
Packaging	Box

**OMNIMATE Signal - series BL/SL 3.50
BL-I/O 3.50/10F SN LTGY BX**

Weidmüller Interface GmbH & Co. KG
Klingenbergstraße 16
D-32758 Detmold
Germany
Fon: +49 5231 14-0
Fax: +49 5231 14-292083
www.weidmueller.com

Technical data
Dimensions and weights

Width	42 mm	Width (inches)	1.654 inch
Height	10.3 mm	Height (inches)	0.406 inch
Depth	27.6 mm	Depth (inches)	1.087 inch
Net weight	11.2 g		

System parameters

Product family	OMNIMATE Signal - series BL/SL 3.50	Type of connection	Field connection
Wire connection method	PUSH IN, Tension-clamp connection	Pitch in mm (P)	3.5 mm
Pitch in inches (P)	0.138 inch	Conductor outlet direction	180°
No. of poles	10	L1 in mm	31.5 mm
L1 in inches	1.24 inch	Number of rows	1
Pin series quantity	1	Rated cross-section	1 mm ²
Touch-safe protection acc. to DIN VDE 57 106	Safe from finger touch	Touch-safe protection acc. to DIN VDE 0470	IP 20
Can be coded	Yes	Stripping length	8 mm
Tightening torque for screw flange, min.	0.15 Nm	Tightening torque for screw flange, max.	0.2 Nm
Screwdriver blade	0.4 x 2.5	Screwdriver blade standard	DIN 5264
Plugging force/pole, max.	6 N	Pulling force/pole, max.	6 N

Material data

Insulating material	PBT	Colour code	Light Grey
Colour of operational elements	grey, blue, red	Material of operational elements	PBT
Colour chart (similar)	RAL 7035	Insulating material group	IIIa
CTI	≥ 200	Insulation strength	≥ 10 ⁸ Ω
UL 94 flammability rating	V-0	GWFI	960 °C
Contact base material	Copper alloy	Contact material	Copper alloy
Contact surface	tinned	Storage temperature, min.	-25 °C
Storage temperature, max.	55 °C	Max. relative humidity during storage	80 %
Operating temperature, min.	-50 °C	Operating temperature, max.	75 °C
Temperature range, installation, min.	-30 °C	Temperature range, installation, max.	75 °C

Conductors suitable for connection

Clamping range, min.	0.2 mm ²	Clamping range, max.	1.5 mm ²
Wire connection cross section AWG, min.	AWG 24	Wire connection cross section AWG, max.	AWG 16
Solid, min. H05(07) V-U	0.2 mm ²	Solid, max. H05(07) V-U	1.5 mm ²
Flexible, min. H05(07) V-K	0.2 mm ²	Flexible, max. H05(07) V-K	1.5 mm ²
w. plastic collar ferrule, DIN 46228 pt 4, min.	0.2 mm ²	w. plastic collar ferrule, DIN 46228 pt 4, max.	0.75 mm ²
w. wire end ferrule, DIN 46228 pt 1, min.	0.2 mm ²	w. wire end ferrule, DIN 46228 pt 1, max.	1 mm ²
Plug gauge in accordance with EN 60999 a x b; ø	2.4 mm x 1.5 mm; 1.9mm		

**OMNIMATE Signal - series BL/SL 3.50
BL-I/O 3.50/10F SN LTGY BX**

Weidmüller Interface GmbH & Co. KG
Klingenbergstraße 16
D-32758 Detmold
Germany
Fon: +49 5231 14-0
Fax: +49 5231 14-292083
www.weidmueller.com

Technical data**Rated data acc. to IEC**

tested acc. to standard	IEC 60664-1, IEC 61984	Rated current, min. no. of poles (Tu=20°C)	2.2 A
Rated current, max. no. of poles (Tu=20°C)	2 A	Rated current, min. no. of poles (Tu=40°C)	2.2 A
Rated current, max. no. of poles (Tu=40°C)	2 A	Rated voltage for surge voltage class / pollution degree II/2	200 V
Rated voltage for surge voltage class / pollution degree III/2	160 V	Rated voltage for surge voltage class / pollution degree III/3	50 V
Rated impulse voltage for surge voltage class/ pollution degree II/2	2.5 kV	Rated impulse voltage for surge voltage class/ pollution degree III/2	2.5 kV
Rated impulse voltage for surge voltage class/ contamination degree III/3	0.8 kV	Short-time withstand current resistance	3 x 1s with 120 A

Rated data acc. to CSA

Institute (CSA)		Certificate No. (CSA)	154685-1202189
Rated voltage (Use group B / CSA)	50 V	Rated voltage (Use group D / CSA)	50 V
Rated current (Use group B / CSA)	5 A	Rated current (Use group D / CSA)	5 A
Wire cross-section, AWG, min.	AWG 22	Wire cross-section, AWG, max.	AWG 16
Reference to approval values	Specifications are maximum values, details - see approval certificate.		

Rated data acc. to UL 1059

Institute (UR)		Certificate No. (UR)	E60693
Rated voltage (Use group B / UL 1059)	50 V	Rated voltage (Use group D / UL 1059)	50 V
Rated current (Use group B / UL 1059)	5 A	Rated current (Use group D / UL 1059)	5 A
Wire cross-section, AWG, min.	AWG 24	Wire cross-section, AWG, max.	AWG 16
Reference to approval values	Specifications are maximum values, details - see approval certificate.		

Packaging

Packaging	Box	VPE length	35 mm
VPE width	85 mm	VPE height	125 mm

Classifications

ETIM 3.0	EC001284	ETIM 4.0	EC002637
ETIM 5.0	EC002637	ETIM 6.0	EC002637
UNSPSC	30-21-18-10	eClass 5.1	27-26-07-04
eClass 6.2	27-26-07-04	eClass 7.1	27-44-04-02
eClass 8.1	27-44-04-02	eClass 9.0	27-44-04-02
eClass 9.1	27-44-04-02		

**OMNIMATE Signal - series BL/SL 3.50
BL-I/O 3.50/10F SN LTGY BX**

Weidmüller Interface GmbH & Co. KG
Klingenbergstraße 16
D-32758 Detmold
Germany
Fon: +49 5231 14-0
Fax: +49 5231 14-292083
www.weidmueller.com

Technical data

Notes

- | | |
|-------|---|
| Notes | <ul style="list-style-type: none"> • Additional colours on request • P on drawing = pitch • Crimp form A for wire end ferrules with PZ 6/5 crimping tool are recommended for the largest cable sizes. • Total load-carrying capacity of the potential bridges when feeding with 1.5 mm² is max. 17.5 A (so the capacity is 2.18 A for poles 2 through 9) • Wire end ferrule without plastic collar to DIN 46228/1 • Wire end ferrule with plastic collar to DIN 46228/4 • Conductor < 0.2 mm² tinned • Max. outer diameter of the conductor: 2.9 mm • Rated data refer only to the component itself. Clearance and creepage distances to other components are to be designed in accordance with the relevant application standards. |
|-------|---|

IPC conformity	Conformity: The products are developed, manufactured and delivered according international recognized standards and norms and comply with the assured properties in the data sheet resp. fulfill decorative properties in accordance with IPC-A-610 "Class 2". Further claims on the products can be evaluated on request.
----------------	--

Approvals

Approvals



ROHS	Conform
------	---------

Downloads

Approval/Certificate/Document of Conformity	Declaration of the Manufacturer
Brochure/Catalogue	FL DRIVES EN MB DEVICE MANUF. EN FL DRIVES DE CAT 2 PORTFOLIOGUIDE EN FL BUILDING SAFETY EN FL APPL LED LIGHTING EN FLIndustr.CONTROLS EN FL MACHINE SAFETY EN FL HEATING ELECTR EN FL APPL INVERTER EN FL_BASE_STATION_EN FL ELEVATOR EN FL POWER SUPPLY EN FL 72H SAMPLE SER EN PO OMNIMATE EN
Engineering Data	EPLAN_WSCAD
Engineering Data	STEP
White Paper wire connection	Download Whitepaper

Data sheet

**OMNIMATE Signal - series BL/SL 3.50
BL-I/O 3.50/10F SN LTGY BX**

Weidmüller Interface GmbH & Co. KG
Klingenbergstraße 16
D-32758 Detmold
Germany
Fon: +49 5231 14-0
Fax: +49 5231 14-292083
www.weidmueller.com

Drawings

Dimensional drawing

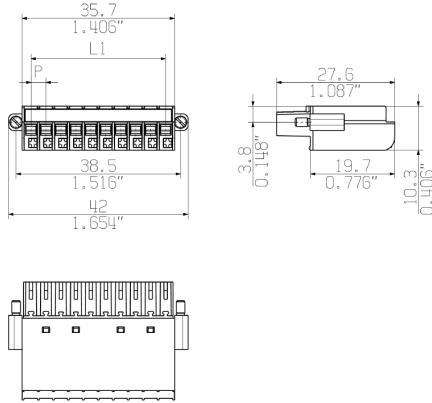

Product benefits

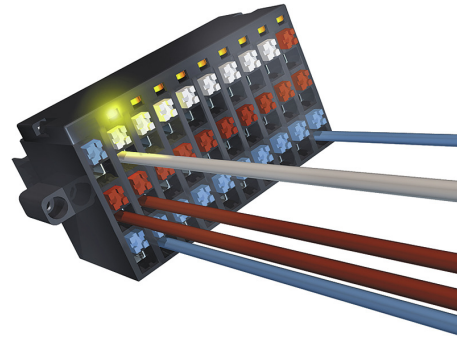

- **Graph** PUSH IN - fast and secure
Invented by Weidmüller

- **Graph** Integrated electronics
For more space on the circuit board

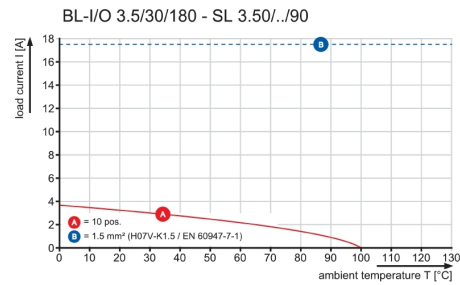
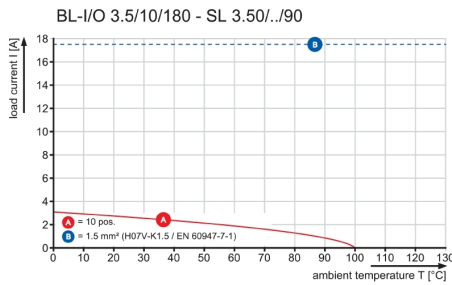

Product benefits

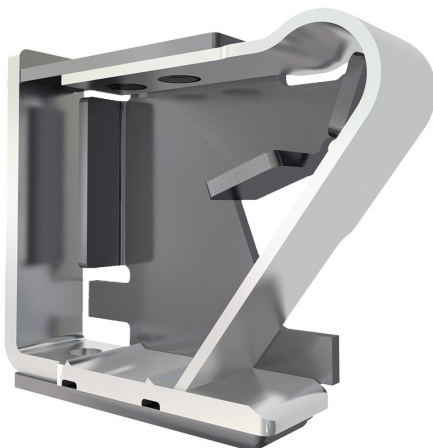

- Solid PUSH IN contact
- Safe and durable

Product benefits

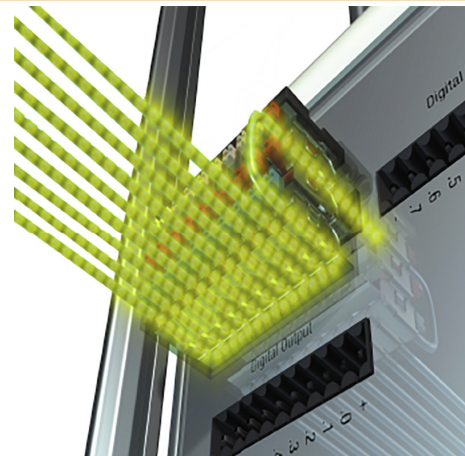

- Multiplies the potential
- Low wiring costs