

Data sheet | Item number: 890-621

T-distribution connector; 5-pole; Cod. A; 1 input; 2 outputs; 2 locking levers;
black

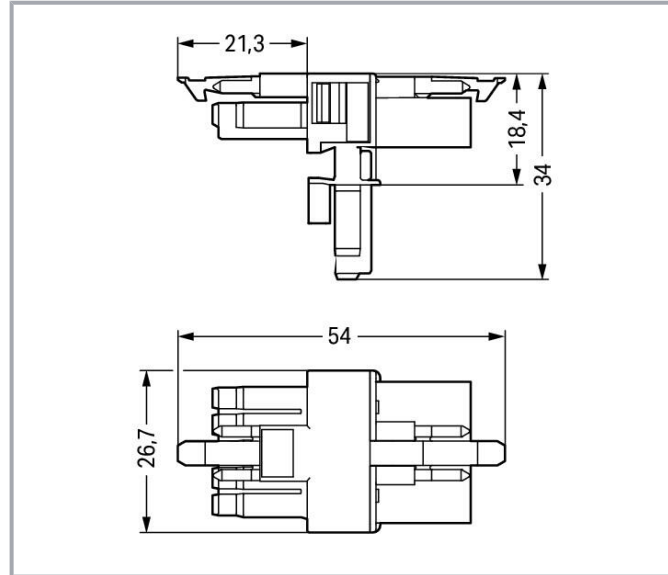

www.wago.com/890-621



Item description

Distribution connector *WINSTA*® MINI A coding

For power and signal transmission: The *WINSTA*® MINI distribution connector with locking latch. Our pluggable installation connectors with spring pressure connection technology work without screw connections. They allow flexible, error-free installation in numerous possible uses. The color coding and mechanical coding of the pluggable installation connector ensure error-free installation of the individual components – including protection against mismatching. Thanks to the color coding and mechanical A coding of *WINSTA*® MINI pluggable installation connectors, you can clearly distinguish different circuits. *WINSTA*® MINI satisfies the demand for miniaturisation. Our smallest pluggable connection system is primarily suited for lights, for example, since as a result of LED technology; due to complex systems, these offer less and less space for the connection technology.

Subject to changes. Please also observe the further product documentation!

WAGO GmbH & Co. KG
Hansastr. 27
32423 Minden
Phone: +49571 887-0 | Fax: +49571 887-169
Email: info.de@wago.com | Web: www.wago.com

Do you have any questions about our products?
We are always happy to take your call at +49 (571) 887-44222.



Lower costs through fast commissioning and elimination of service expenses – solutions from WINSTA® MINI

WINSTA® is the pluggable connection system that is ideally tailored to the strict requirements of electrical installation. It ensures error-free installation of cables and components, quickly and reliably. Now you can also reduce installation costs without compromising quality and safety: The WINSTA® MINI pluggable installation connector with marking reduces the need for servicing and prevents unnecessary downtime.

- effective protection against mismatching
- easy tool-free operation, a wide range of coding options
- with A coding for a great number of uses
- ready to install and use immediately
- convenient installation and commissioning

Data

Electrical data

Ratings per IEC/EN

Ratings per	IEC/EN 60664-1
Nominal voltage (III/3)	400 V
Rated impulse voltage (III/3)	6 kV
Rated current	13 A
Legend (ratings)	(III / 3) ≙ Overvoltage category III / Pollution degree 3

Ratings per UL 1977

Note for the US market	Some versions may also be used for current interruption in accordance with the UL certificate in select applications with currents below 5 A and voltages up to 600 V. For further information, please contact your local sales office.
Rated voltage (UL 1977)	600 V
Rated current UL 1977	12 A

General

Note on contact resistance	approx. 1 mΩ of contact resistance approx. 0.25 mΩ contact transition plug/socket
----------------------------	--

Subject to changes. Please also observe the further product documentation!

Connection data

Total number of potentials	5
----------------------------	---

Connection 1

Pole number	5
-------------	---

Physical data

Pin spacing	4.4 mm / 0.173 inches
Width	26.7 mm / 0.705 inches
Height	34 mm / 1.339 inches
Depth	54 mm / 2.122 inches

Mechanical Data

Application	General mains applications
Coding	A
Variable coding	No
Marking	N $\frac{1}{2}$ 1 2 3
Potential marking	N $\frac{1}{2}$ 1 2 3
Mating force of a plug-in connection	approx. 20 ... 70 N (depending on pole number)
Retention force of a plug-in connection	When locked: > 80 N
Unmating force of a plug-in connection	Unlocked: approx. 20 ... 70 N (depending on pole number)
Number of mating cycles	200, without resistive load
Type of distribution box	T-distribution connector
Protection type	IP20; IP40 when mated

Plug-in connection

Contact type (pluggable connector)	Socket/plug
Mismating protection	Yes
Note on mismating protection	All WINSTA [®] components are 100% protected against mismating when: a.) plugging different numbers of poles b.) plugging while rotated 180 c.) plugging while laterally staggered d.) plugging one pole
Locking lever	yes
Locking of plug-in connection	locking lever

Subject to changes. Please also observe the further product documentation!



Note on locking system

All connectors for mounted installations (snap-in versions for lighting fixtures or devices, all types of PCB and distribution connectors) are factory-equipped with locking levers to ensure plugs and sockets are securely locked. Additional locking levers are only required for flying leads (plug/socket).

Material Data

Note (material data)

Information on material specifications can be found here

Color	black
Insulation material	Polyamide (PA66)
Flammability class per UL94	V0
Contact material	Copper or copper alloy; surface-treated
Contact plating	Tin
Fire load	0.245 MJ
Weight	12.2 g

Environmental requirements

Processing temperature	-5 ... +40 °C
Continuous operating temperature	-35 ... +85 °C
Note on continuous operating temperature	Insulating parts for temperatures ≤ 105 °C

Commercial data

Product Group	20 (Winsta)
eCl@ss 10.0	27-44-06-03
eCl@ss 9.0	27-44-06-03
ETIM 8.0	EC002567
ETIM 7.0	EC002567
PU (SPU)	25 pcs
Packaging type	box
Country of origin	DE
GTIN	4050821229506
Customs tariff number	85366990990



Environmental Product Compliance

RoHS Compliance Status	Compliant, No Exemption
------------------------	-------------------------



Subject to changes. Please also observe the further product documentation!

Approvals / Certificates



General approvals

Logo	Approval	Additional Approval Text	Certificate name
	CCA DEKRA Certification B.V.	EN 61535	71-123231
	CCA DEKRA Certification B.V.	IEC 61535	NL-85020
	cURus Underwriters Laboratories Inc.	UL 1977	E45171

Declarations of conformity and manufacturer's declarations

Logo	Approval	Additional Approval Text	Certificate name
	EU-Declaration of Conformity WAGO GmbH & Co. KG	-	-
	UK-Declaration of Conformity WAGO GmbH & Co. KG	-	-

Approvals for marine applications







Logo	Approval	Additional Approval Text	Certificate name
	ABS American Bureau of Shipping	Steel Vessel Rules	19-HG1869855-PDA
	DNV GL Det Norske Veritas, Germanischer Lloyd	-	TAE00001Z6
	LR Lloyds Register	EN 61535	08/20047 (E2)

Subject to changes. Please also observe the further product documentation!

WAGO GmbH & Co. KG
Hansastr. 27
32423 Minden
Phone: +49571 887-0 | Fax: +49571 887-169
Email: info.de@wago.com | Web: www.wago.com

Do you have any questions about our products?
We are always happy to take your call at +49 (571) 887-44222.

Counterpart

	Item no.890-105 Socket; with strain relief housing; 5-pole; Cod. A; 1,50 mm ² ; black	www.wago.com/890-105
	Item no.890-115 Plug; with strain relief housing; 5-pole; 1,50 mm ² ; black	www.wago.com/890-115
	Item no.890-205 Socket; 5-pole; Cod. A; 1,50 mm ² ; black	www.wago.com/890-205
	Item no.891-8995/006-101 pre-assembled interconnecting cable; Eca; Socket/plug; 5-pole; Cod. A; H05VV-F 5G 1.5 mm ² ; 1 m; 1,50 mm ² ; black	www.wago.com/891-8995/006-101
	Item no.891-8995/106-101 pre-assembled connecting cable; Eca; Socket/open-ended; 5-pole; Cod. A; H05VV-F 5G 1.5 mm ² ; 1 m; 1,50 mm ² ; black	www.wago.com/891-8995/106-101
	Item no.890-215 Plug; 5-pole; Cod. A; 1,50 mm ² ; black	www.wago.com/890-215
	Item no.891-8995/206-101 pre-assembled connecting cable; Eca; Plug/open-ended; 5-pole; Cod. A; H05VV-F 5G 1.5 mm ² ; 1 m; 1,50 mm ² ; black	www.wago.com/891-8995/206-101

Downloads

Documentation

Bid Text

890-621 X81 - Datei	2019 Feb 19	xml 2.8 kB	Download
890-621 doc - Datei	2014 Dec 3	doc 23.0 kB	Download

CAD/CAE-Data

CAD data

2D/3D Models 890-621	URL	Download
----------------------	-----	----------

CAE data

WSCAD Universe 890-621	URL	Download
ZUKEN Portal 890-621	URL	Download

Subject to changes. Please also observe the further product documentation!

Environmental Product Compliance

Compliance Search

Environmental Product Compliance 890-621

URL

Download

T-distribution connector; 5-pole; Cod. A; 1 input; 2 outputs; 2 locking levers; black

Installation Notes

Installation

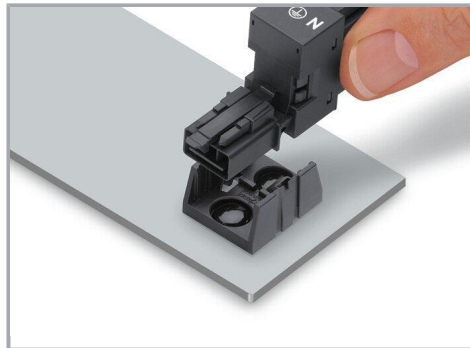

Secure the mounting plate via pins.

Product family

WINSTA® MINI

[Show all products from the family](#)

Subject to changes. Please also observe the further product documentation!