

ST-204A1

Aliases (UDLST00204A100)

KEMET, ST, DC Line Filters, Common Mode

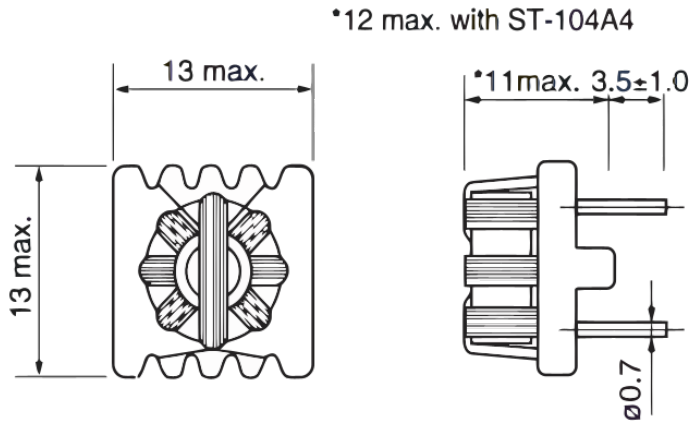

Click [here](#) for the 3D model.

Dimensions

L	13mm MAX
W	13mm MAX
H	11mm MAX
LL	3.5mm +/-1mm

Packaging Specifications

Packaging	Tray, Box
Packaging Quantity	4800
Component Weight	2.13 g

General Information

Series	ST
Style	Through-Hole
RoHS	Yes
Miscellaneous	FM Band, Frequency Range: 7 To 100 MHz, Impedance: 250 Ohms (10 MHz).

Specifications

Voltage DC	50 VDC
Temperature Range	-20/+75°C
DC Resistance	100 mOhms