

G2R1000MT17D

1700 V 1000 mΩ SiC MOSFET



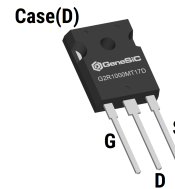
Silicon Carbide MOSFET
N-Channel Enhancement Mode

V_{DS}	=	1700 V
$R_{DS(ON)(Typ.)}$	=	1000 mΩ
$I_D(T_C = 100^\circ C)$	=	3 A

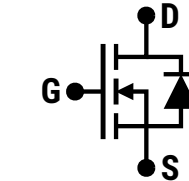
Features

- G2R™ Technology
- Softer $R_{DS(ON)}$ v/s Temperature Dependency
- LoRing™ - Electromagnetically Optimized Design
- Smaller $R_{G(INT)}$ and Lower Q_G
- Low Device Capacitances (C_{OSS} , C_{RSS})
- Superior Cost-Performance Index
- Robust Body Diode with Low V_F and Low Q_{RR}
- Industry-Leading UIL & Short-Circuit Robustness

Package



TO-247-3



D = Drain
G = Gate
S = Source



Advantages

- Compatible with Commercial Gate Drivers
- Low Conduction Losses at all Temperatures
- Reduced Ringing
- Faster and More Efficient Switching
- Lesser Switching Spikes and Lower Losses
- Better Power Density and System Efficiency
- Ease of Paralleling without Thermal Runaway
- Higher System Reliability

Applications

- Auxiliary Power Supply
- Solar Inverters (String and Central)
- Infrastructure Chargers
- Industrial Motors (AC Servos)
- General Purpose Inverters
- Pulsed Power
- Piezo Drivers
- Ion Beam Generators

Absolute Maximum Ratings (At $T_C = 25^\circ C$ Unless Otherwise Stated)

Parameter	Symbol	Conditions	Values	Unit	Note
Drain-Source Voltage	$V_{DS(max)}$	$V_{GS} = 0 V, I_D = 100 \mu A$	1700	V	
Gate-Source Voltage (Dynamic)	$V_{GS(max)}$		-10 / +25	V	
Gate-Source Voltage (Static)	$V_{GS(op)}$	Recommended Operation	-5 / +20	V	
Continuous Forward Current	I_D	$T_C = 25^\circ C, V_{GS} = -5 / +20 V$	5	A	Fig. 15
		$T_C = 100^\circ C, V_{GS} = -5 / +20 V$	3		
		$T_C = 135^\circ C, V_{GS} = -5 / +20 V$	3		
Pulsed Drain Current	$I_{D(pulse)}$	$t_P \leq 3 \mu s, D \leq 1\%, V_{GS} = 20 V, \text{Note 1}$	8	A	Fig. 14
Power Dissipation	P_D	$T_C = 25^\circ C$	44	W	Fig. 16
Non-Repetitive Avalanche Energy	E_{AS}	$L = 90 mH, I_{AS} = 1.0 A$	45	mJ	
Operating and Storage Temperature	T_j, T_{stg}		-55 to 175	$^\circ C$	

Thermal/Package Characteristics

Parameter	Symbol	Conditions	Values			Unit	Note
			Min.	Typ.	Max.		
Thermal Resistance, Junction - Case	R_{thJC}		2.97	3.41		$^\circ C/W$	Fig. 13
Weight	W_T		6.1			g	
Mounting Torque	T_M	Screws to Heatsink		1.1		Nm	

Note 1: Pulse Width t_P Limited by $T_{j(max)}$

Electrical Characteristics (At $T_C = 25^\circ\text{C}$ Unless Otherwise Stated)

Parameter	Symbol	Conditions	Values			Unit	Note
			Min.	Typ.	Max.		
Drain-Source Breakdown Voltage	V_{DSS}	$V_{GS} = 0\text{ V}, I_D = 100\ \mu\text{A}$	1700			V	
Zero Gate Voltage Drain Current	I_{DSS}	$V_{DS} = 1700\text{ V}, V_{GS} = 0\text{ V}$		1		μA	
Gate Source Leakage Current	I_{GSS}	$V_{DS} = 0\text{ V}, V_{GS} = 25\text{ V}$			100	nA	
		$V_{DS} = 0\text{ V}, V_{GS} = -10\text{ V}$			-100		
Gate Threshold Voltage	$V_{GS(th)}$	$V_{DS} = V_{GS}, I_D = 2.0\text{ mA}$	2.0	3.00		V	Fig. 9
		$V_{DS} = V_{GS}, I_D = 2.0\text{ mA}, T_j = 175^\circ\text{C}$		2.00			
Transconductance	g_{fs}	$V_{DS} = 10\text{ V}, I_D = 2\text{ A}$		0.76		S	Fig. 4
		$V_{DS} = 10\text{ V}, I_D = 2\text{ A}, T_j = 175^\circ\text{C}$		0.84			
Drain-Source On-State Resistance	$R_{DS(on)}$	$V_{GS} = 20\text{ V}, I_D = 2\text{ A}$		1000	1250	mΩ	Fig. 5-8
		$V_{GS} = 20\text{ V}, I_D = 2\text{ A}, T_j = 175^\circ\text{C}$		1479			
Input Capacitance	C_{iss}			111			
Output Capacitance	C_{oss}			19		pF	Fig. 11
Reverse Transfer Capacitance	C_{rss}			5.0			
C_{oss} Stored Energy	E_{oss}	$V_{DS} = 1000\text{ V}, V_{GS} = 0\text{ V}$ $f = 1\text{ MHz}, V_{AC} = 25\text{ mV}$		10		μJ	Fig. 12
C_{oss} Stored Charge	Q_{oss}			23		nC	
Effective Output Capacitance (Energy Related)	$C_{o(er)}$			20		pF	Note 2
Effective Output Capacitance (Time Related)	$C_{o(tr)}$			23			
Gate-Source Charge	Q_{gs}	$V_{DS} = 1000\text{ V}, V_{GS} = -5 / +20\text{ V}$		2		nC	Fig. 10
Gate-Drain Charge	Q_{gd}	$I_D = 2\text{ A}$		7			
Total Gate Charge	Q_g	Per IEC607478-4		11			
Internal Gate Resistance	$R_{G(int)}$	$f = 1\text{ MHz}, V_{AC} = 25\text{ mV}$		5.0		Ω	
Turn-On Switching Energy (Body Diode)	E_{on}	$T_j = 25^\circ\text{C}, V_{GS} = -5/+20\text{V}, R_{G(ext)} = 8\ \Omega, L = 1000.0\ \mu\text{H}, I_D = 2\text{ A}, V_{DD} = 1200\text{ V}$		50		μJ	Fig. 22,26
Turn-Off Switching Energy (Body Diode)	E_{off}			16			
Turn-On Delay Time	$t_{d(on)}$	$V_{DD} = 1200\text{ V}, V_{GS} = -5/+20\text{V}$ $R_{G(ext)} = 8\ \Omega, L = 1000.0\ \mu\text{H}, I_D = 2\text{ A}$ Timing relative to V_{DS} , Inductive load		7		ns	Fig. 24
Rise Time	t_r			13			
Turn-Off Delay Time	$t_{d(off)}$			9			
Fall Time	t_f			8			

*The chip technology was characterized up to 200 V/ns. The measured dV/dt was limited by measurement test setup and package.

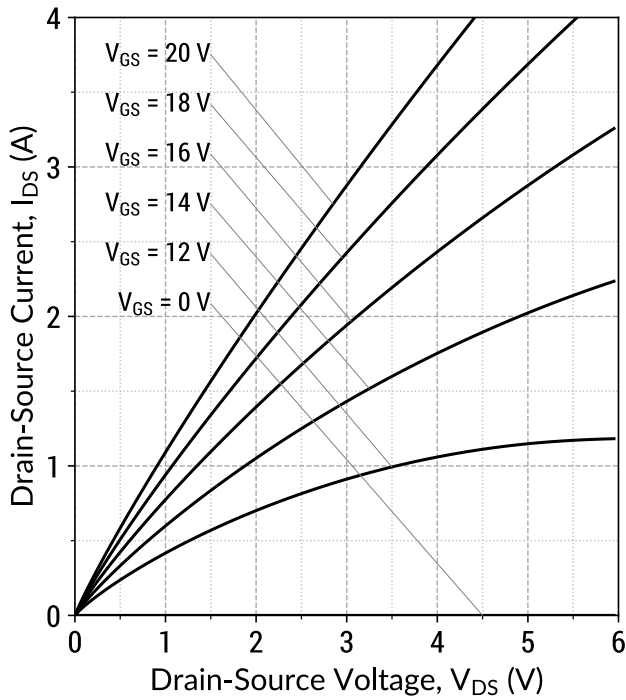
Note 2: $C_{o(er)}$, a lumped capacitance that gives same stored energy as C_{oss} while V_{DS} is rising from 0 to 1000V.

$C_{o(tr)}$, a lumped capacitance that gives same charging times as C_{oss} while V_{DS} is rising from 0 to 1000V.

Reverse Diode Characteristics

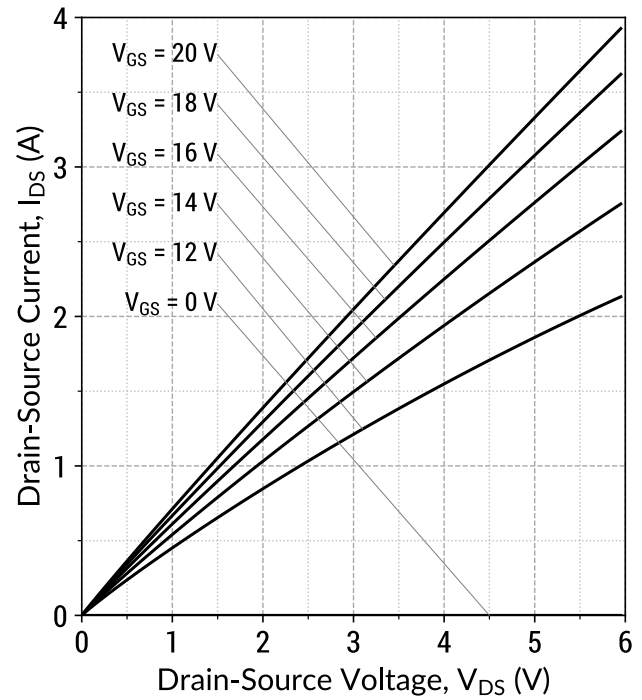
Parameter	Symbol	Conditions	Values			Unit	Note
			Min.	Typ.	Max.		
Diode Forward Voltage	V_{SD}	$V_{GS} = -5\text{ V}, I_{SD} = 1\text{ A}$ $V_{GS} = -5\text{ V}, I_{SD} = 1\text{ A}, T_j = 175^\circ\text{C}$		4.0 3.6		V	Fig. 17-18
Continuous Diode Forward Current	I_S	$V_{GS} = -5\text{ V}, T_c = 100^\circ\text{C}$	3			A	
Diode Pulse Current	$I_{S(\text{pulse})}$	$V_{GS} = -5\text{ V}, \text{Note 1}$		12		A	
Reverse Recovery Time	t_{rr}			21		ns	
Reverse Recovery Charge	Q_{rr}	$V_{GS} = -5\text{ V}, I_{SD} = 2\text{ A}, V_R = 1200\text{ V}$ $dif/dt = 550\text{ A}/\mu\text{s}, T_j = 25^\circ\text{C}$		27		nC	
Peak Reverse Recovery Current	I_{rrm}			2		A	
Reverse Recovery Time	t_{rr}			36		ns	
Reverse Recovery Charge	Q_{rr}	$V_{GS} = -5\text{ V}, I_{SD} = 2\text{ A}, V_R = 1200\text{ V}$ $dif/dt = 550\text{ A}/\mu\text{s}, T_j = 175^\circ\text{C}$		101		nC	
Peak Reverse Recovery Current	I_{rrm}			5		A	

Figure 1: Output Characteristics ($T_j = 25^\circ\text{C}$)



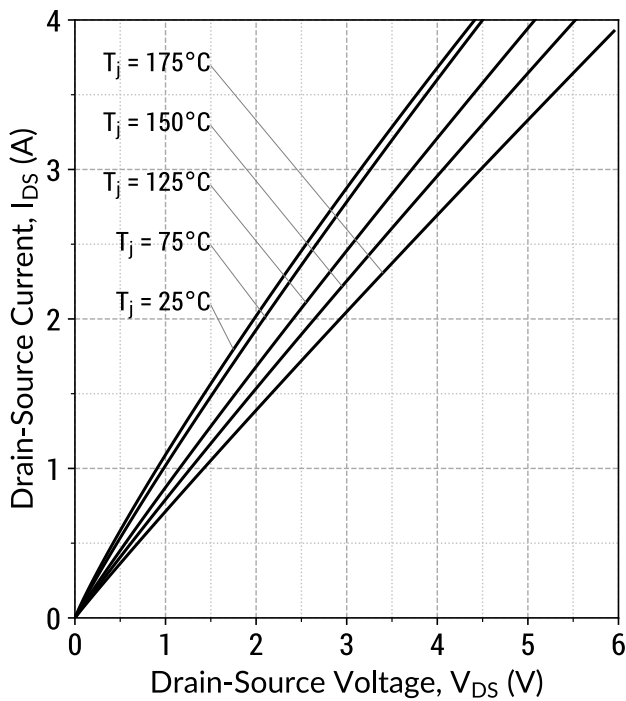
$I_D = f(V_{DS}, V_{GS}); t_P = 250 \mu\text{s}$

Figure 2: Output Characteristics ($T_j = 175^\circ\text{C}$)



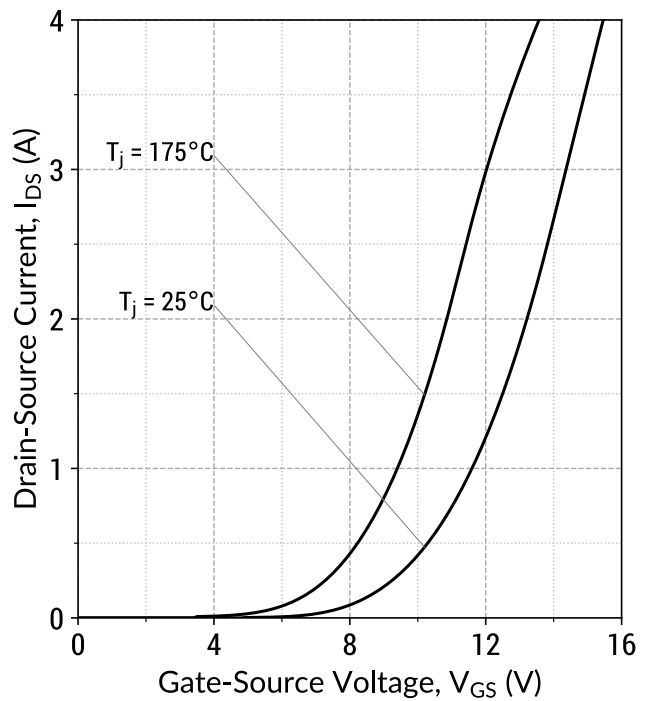
$I_D = f(V_{DS}, V_{GS}); t_P = 250 \mu\text{s}$

Figure 3: Output Characteristics ($V_{GS} = 20\text{ V}$)



$I_D = f(V_{DS}, T_j); t_P = 250 \mu\text{s}$

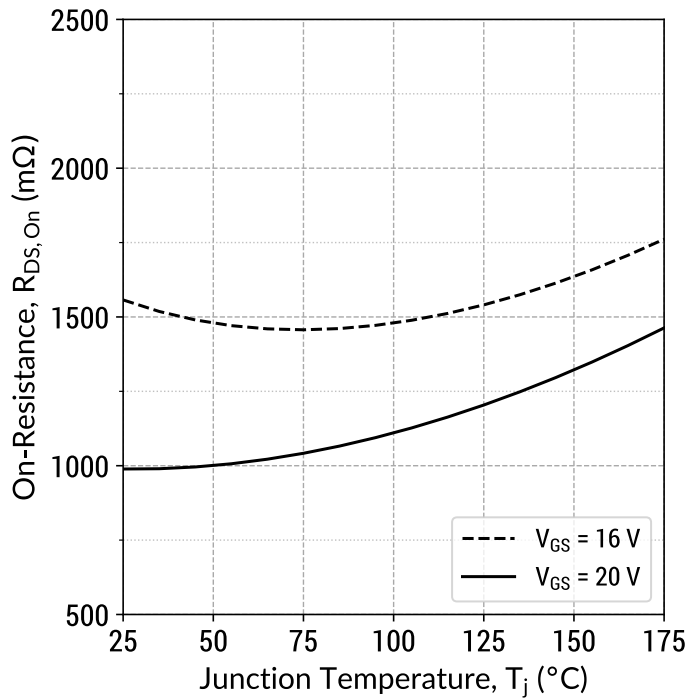
Figure 4: Transfer Characteristics ($V_{DS} = 10\text{ V}$)



$I_D = f(V_{GS}, T_j); t_P = 100 \mu\text{s}$

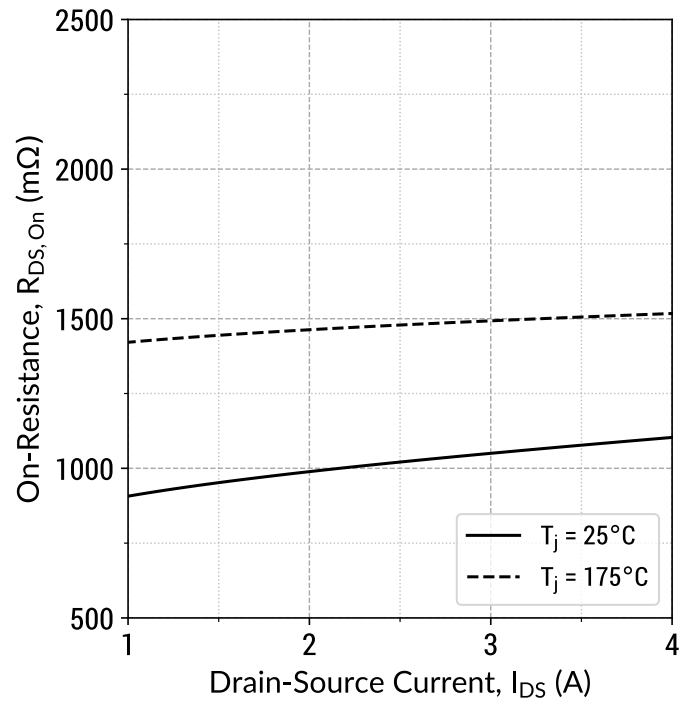


Figure 5: On-State Resistance v/s Temperature



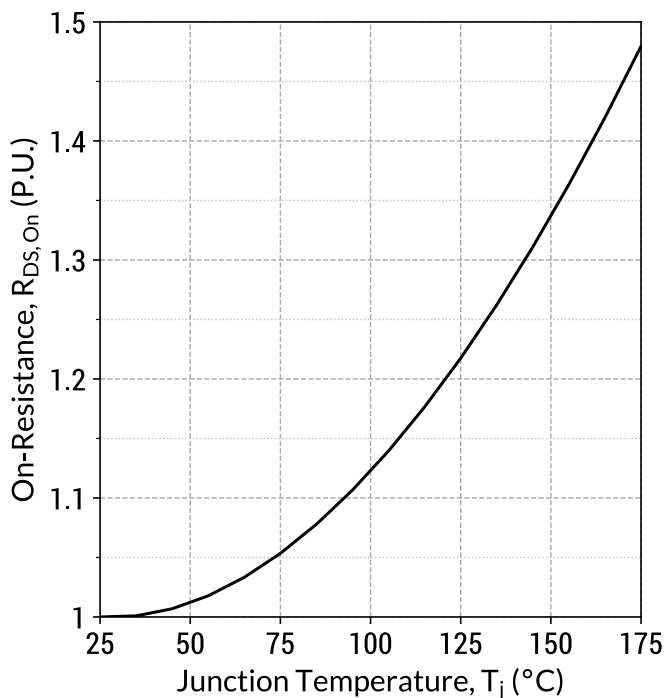
$R_{DS(ON)} = f(T_j, V_{GS}); t_P = 250\ \mu\text{s}; I_D = 2\text{ A}$

Figure 6: On-State Resistance v/s Drain Current



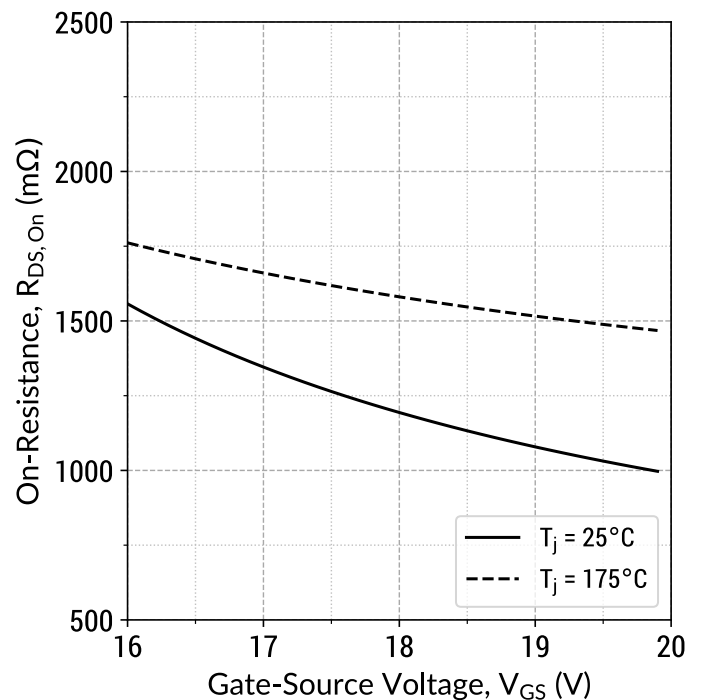
$R_{DS(ON)} = f(T_j, I_D); t_P = 250\ \mu\text{s}; V_{GS} = 20\text{ V}$

Figure 7: Normalized On-State Resistance v/s Temperature



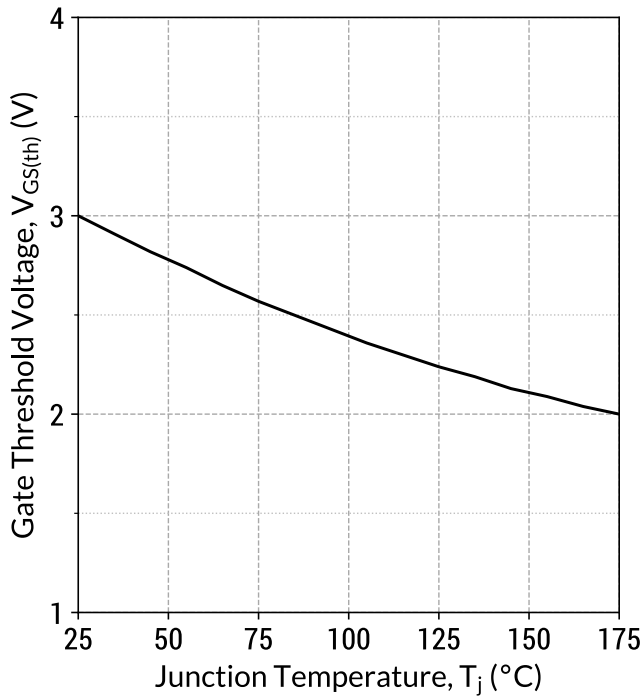
$R_{DS(ON)} = f(T_j); t_P = 250\ \mu\text{s}; I_D = 2\text{ A}; V_{GS} = 20\text{ V}$

Figure 8: On-State Resistance v/s Gate Voltage



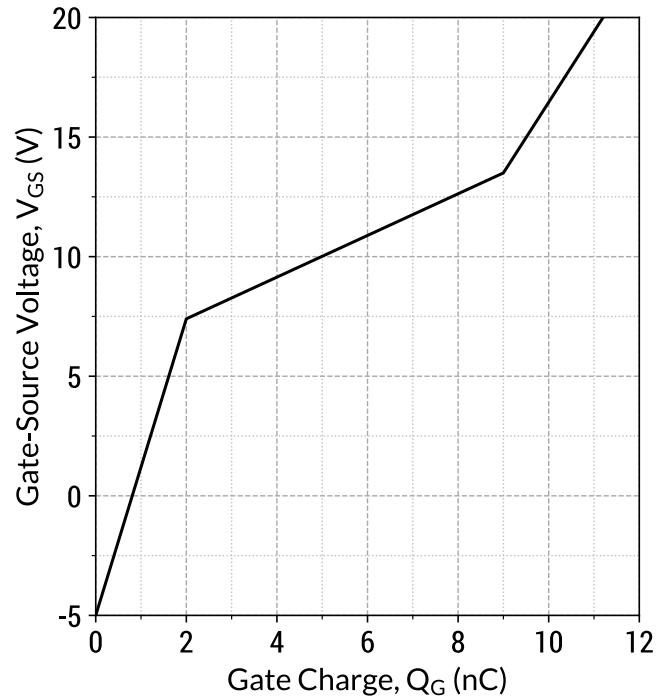
$R_{DS(ON)} = f(T_j, V_{GS}); t_P = 250\ \mu\text{s}; I_D = 2\text{ A}$

Figure 9: Threshold Voltage Characteristics



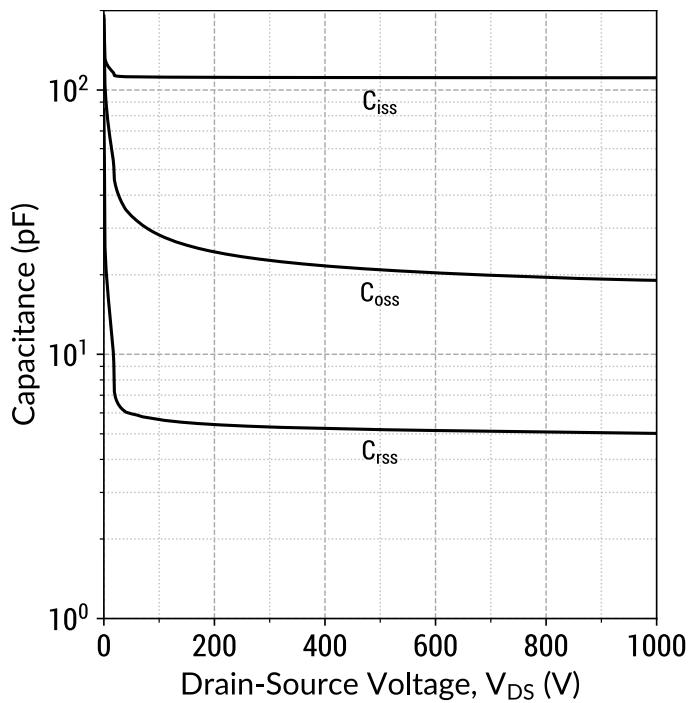
$V_{GS(th)} = f(T_j); V_{DS} = V_{GS}; I_D = 2.0 \text{ mA}$

Figure 10: Gate Charge Characteristics



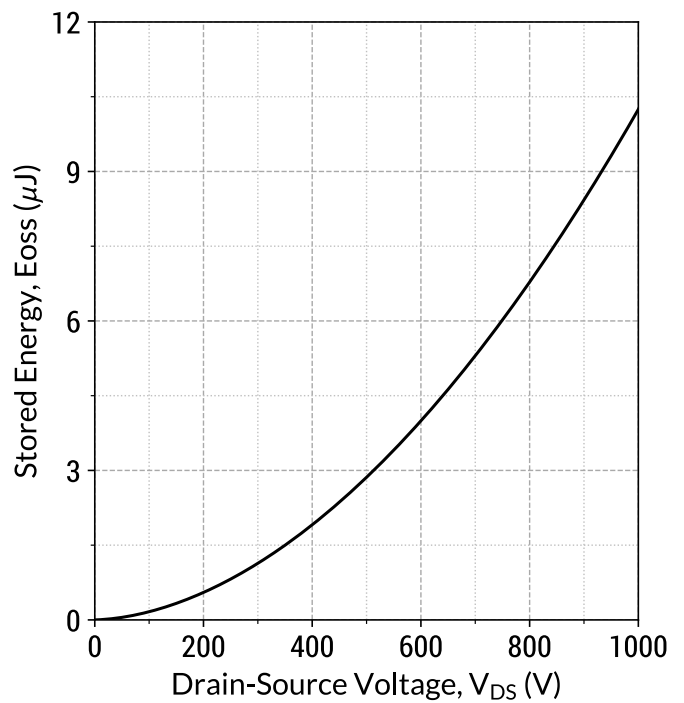
$I_D = 2 \text{ A}; V_{DS} = 1000 \text{ V}; T_c = 25^\circ\text{C}$

Figure 11: Capacitance v/s Drain-Source Voltage



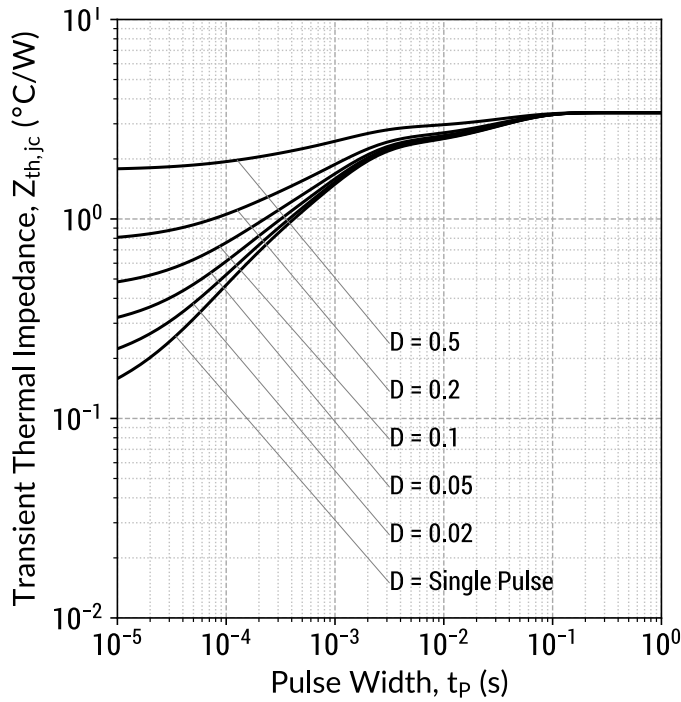
$f = 1 \text{ MHz}; V_{AC} = 25 \text{ mV}$

Figure 12: Output Capacitor Stored Energy



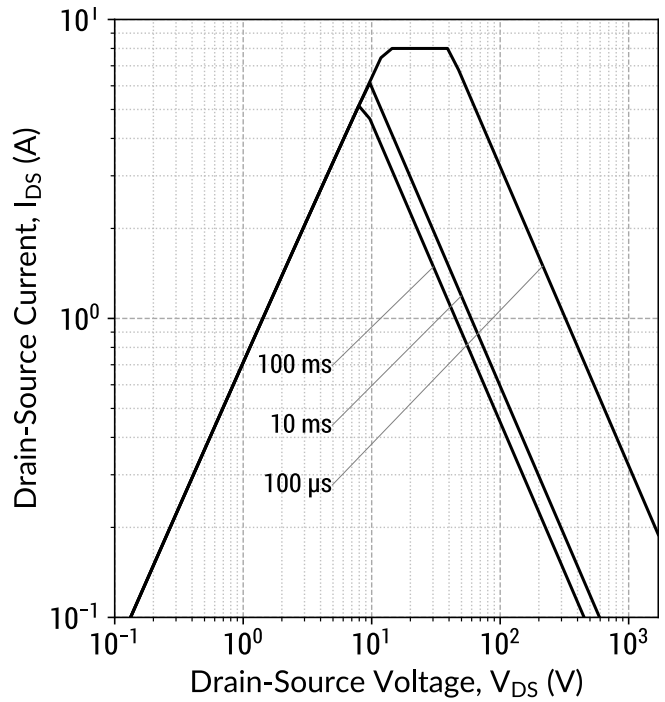
$E_{oss} = f(V_{DS})$

Figure 13: Transient Thermal Impedance



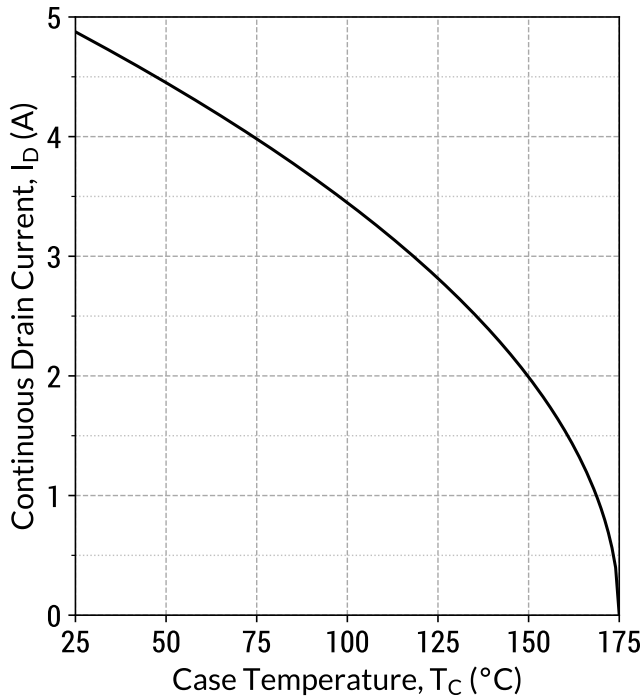
$$Z_{th,jc} = f(t_p, D); D = t_p/T$$

Figure 14: Safe Operating Area ($T_c = 25^\circ\text{C}$)



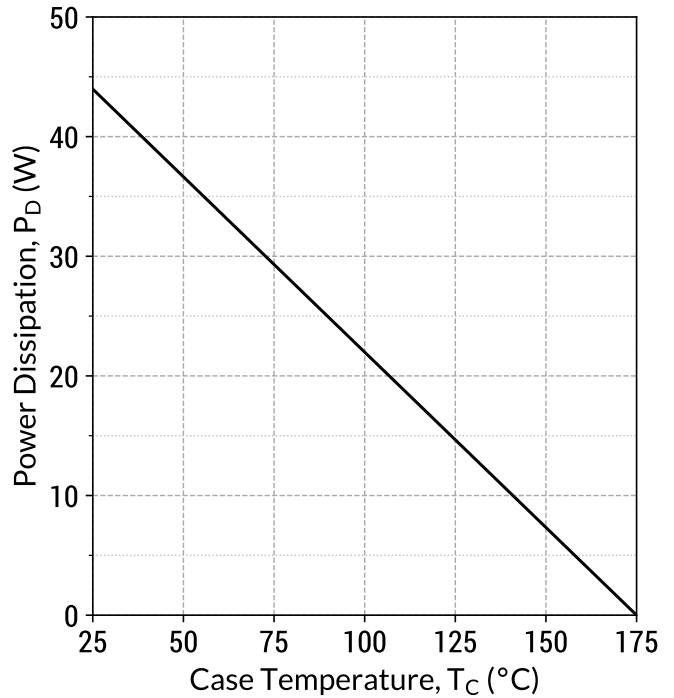
$$I_D = f(V_{DS}, t_p); T_j \leq 175^\circ\text{C}; D = 0$$

Figure 15: Current De-rating Curve



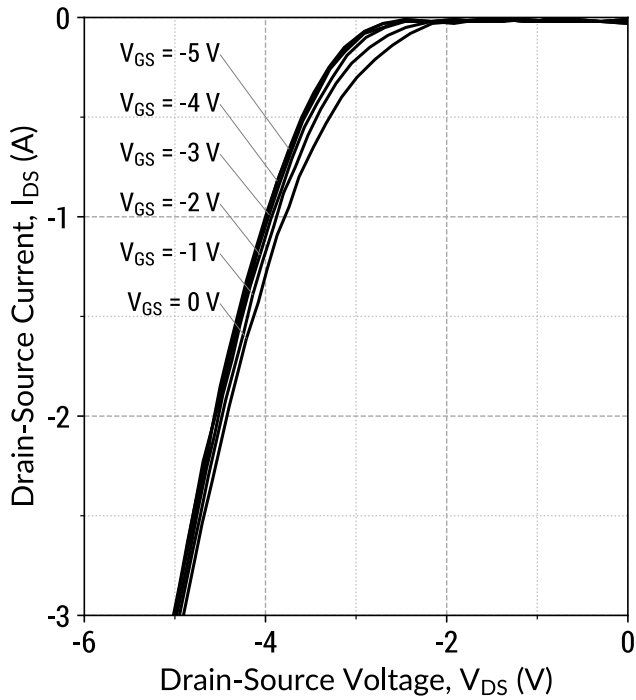
$$I_D = f(T_C); T_j \leq 175^\circ\text{C}$$

Figure 16: Power De-rating Curve



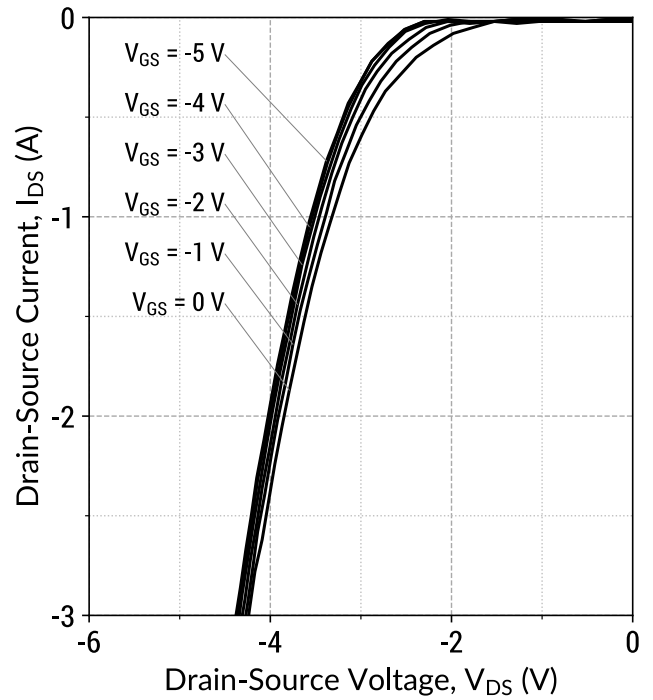
$$P_D = f(T_C); T_j \leq 175^\circ\text{C}$$

Figure 17: Body Diode Characteristics ($T_j = 25^\circ\text{C}$)



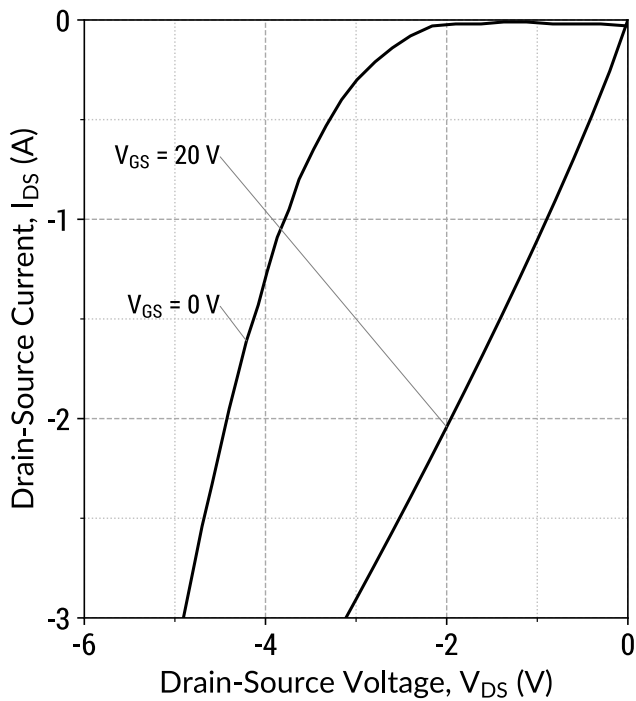
$I_D = f(V_{DS}, V_{GS}); t_P = 250 \mu\text{s}$

Figure 18: Body Diode Characteristics ($T_j = 175^\circ\text{C}$)



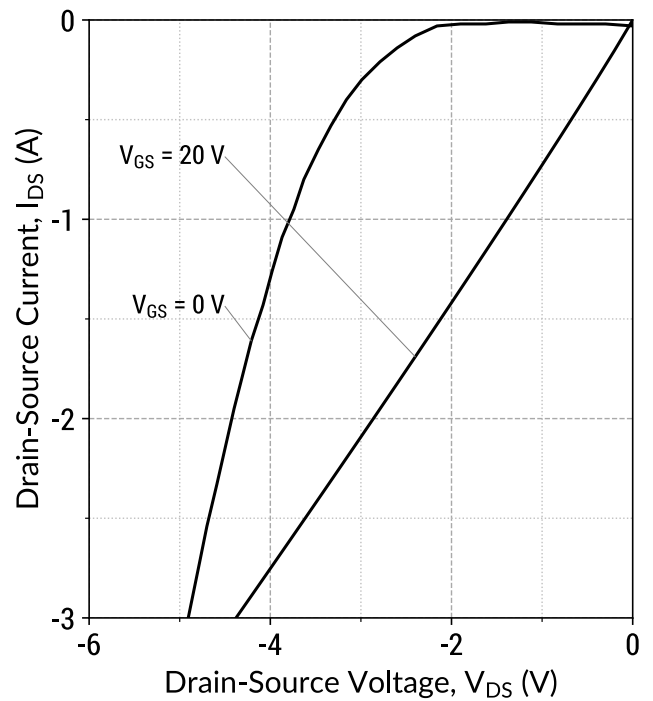
$I_D = f(V_{DS}, V_{GS}); t_P = 250 \mu\text{s}$

Figure 19: Third Quadrant Characteristics ($T_j = 25^\circ\text{C}$)



$I_D = f(V_{DS}, V_{GS}); t_P = 250 \mu\text{s}$

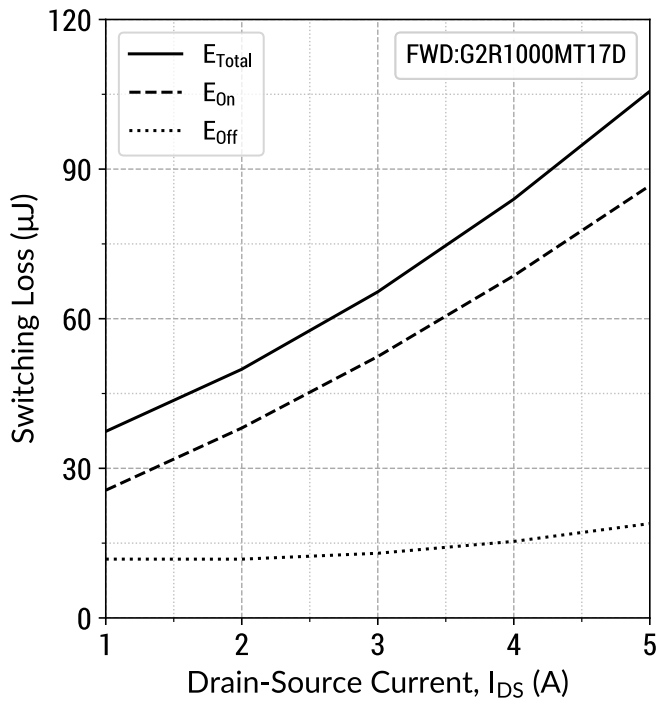
Figure 20: Third Quadrant Characteristics ($T_j = 175^\circ\text{C}$)



$I_D = f(V_{DS}, V_{GS}); t_P = 250 \mu\text{s}$

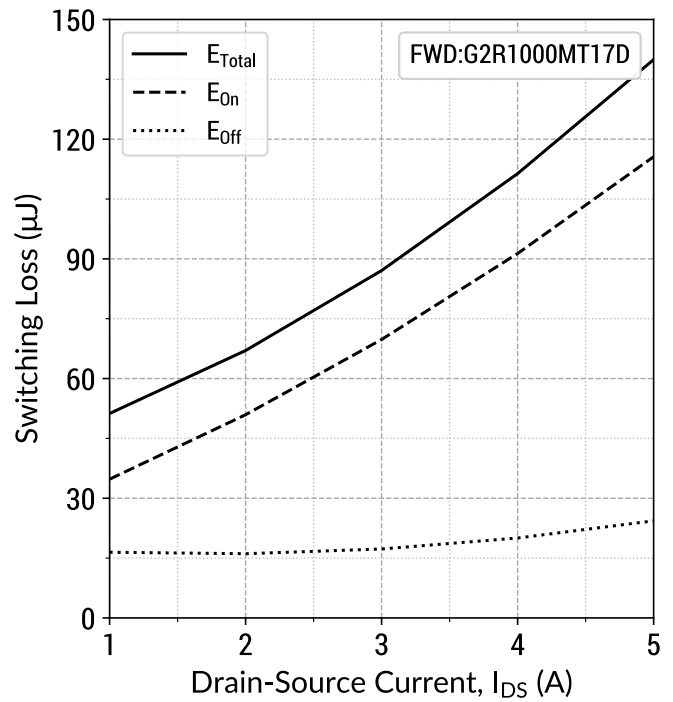


Figure 21: Inductive Switching Energy v/s Drain Current ($V_{DD} = 1000V$)



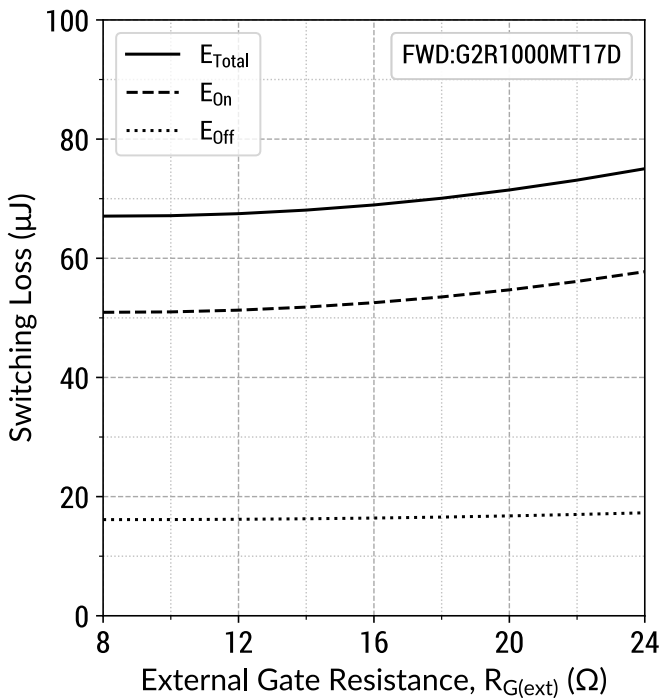
$T_j = 25^\circ C$; $V_{GS} = -5/+20V$; $R_{G(ext)} = 8 \Omega$; $L = 1000.0\mu H$

Figure 22: Inductive Switching Energy v/s Drain Current ($V_{DD} = 1200V$)



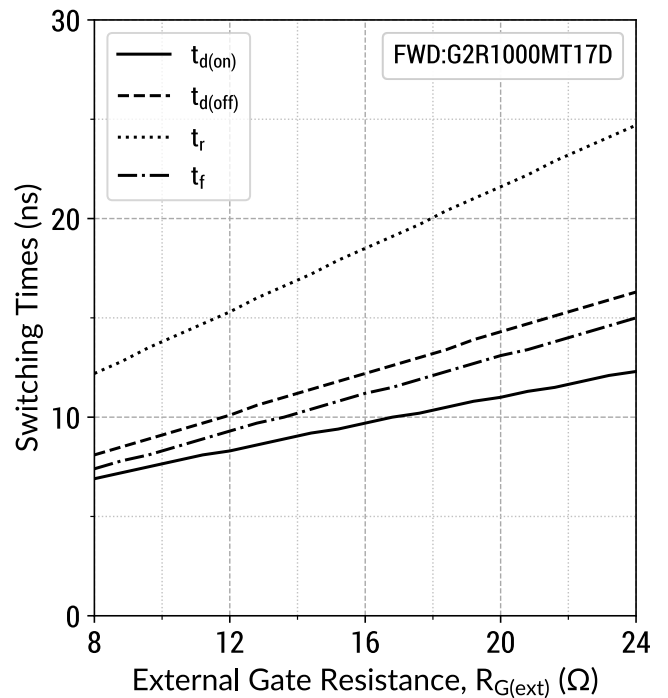
$T_j = 25^\circ C$; $V_{GS} = -5/+20V$; $R_{G(ext)} = 8 \Omega$; $L = 1000.0\mu H$

Figure 23: Inductive Switching Energy v/s $R_{G(ext)}$ ($V_{DD} = 1200V$)



$T_j = 25^\circ C$; $V_{GS} = -5/+20V$; $I_{DS} = 2 A$; $L = 1000.0\mu H$

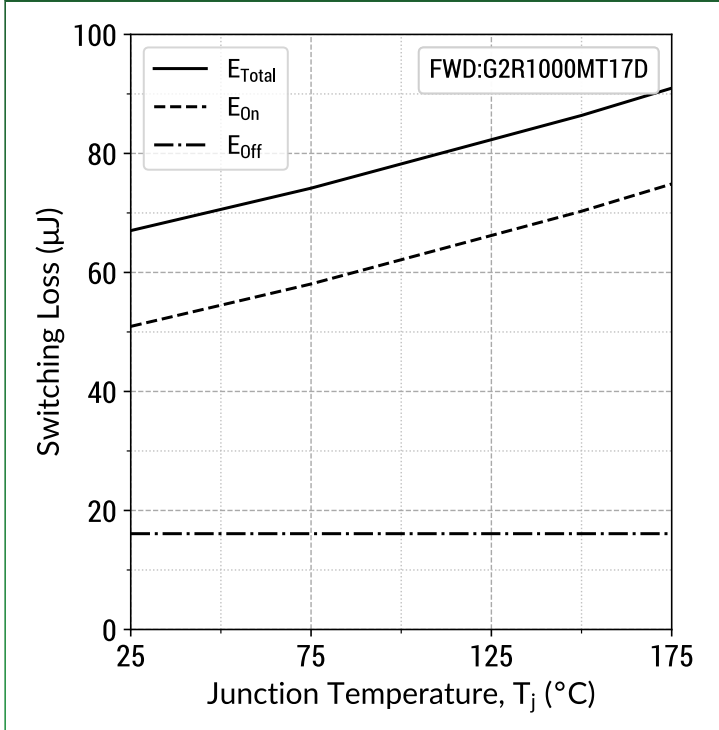
Figure 24: Switching Time v/s $R_{G(ext)}$ ($V_{DD} = 1200V$)



$T_j = 25^\circ C$; $V_{GS} = -5/+20V$; $I_{DS} = 2 A$; $L = 1000.0\mu H$

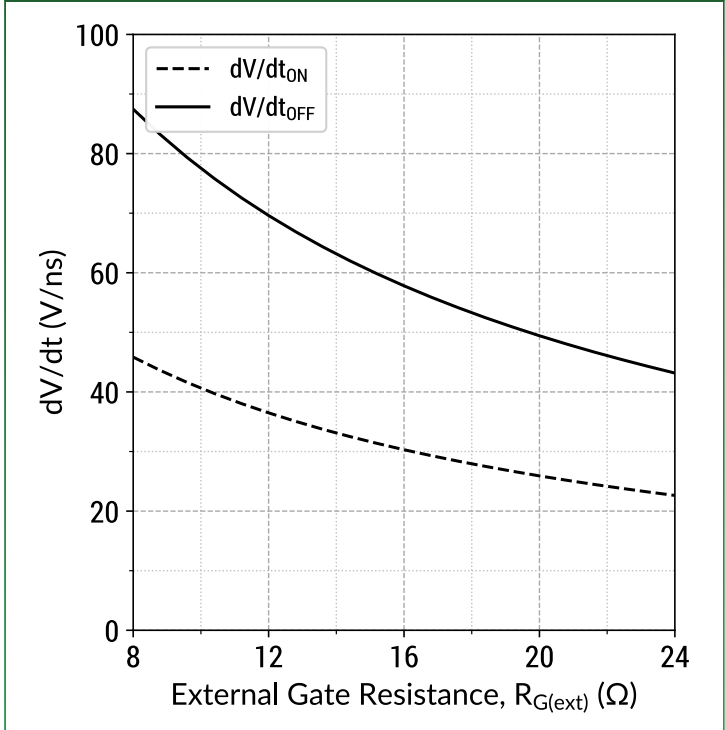


Figure 25: Inductive Switching Energy v/s Temperature
($V_{DD} = 1200V$)



$T_j = 25^\circ C; V_{GS} = -5/+20V; R_{G(ext)} = 8 \Omega; I_{DS} = 2 A; L = 1000.0\mu H$

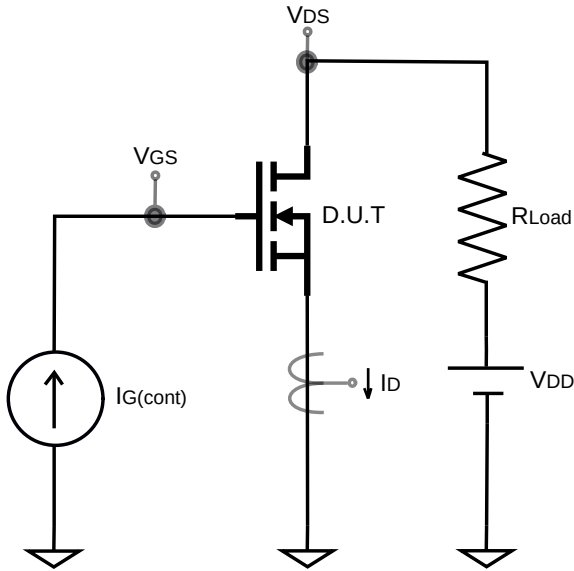
Figure 26: dV/dt v/s $R_{G(ext)}$
($V_{DD} = 1200V$)



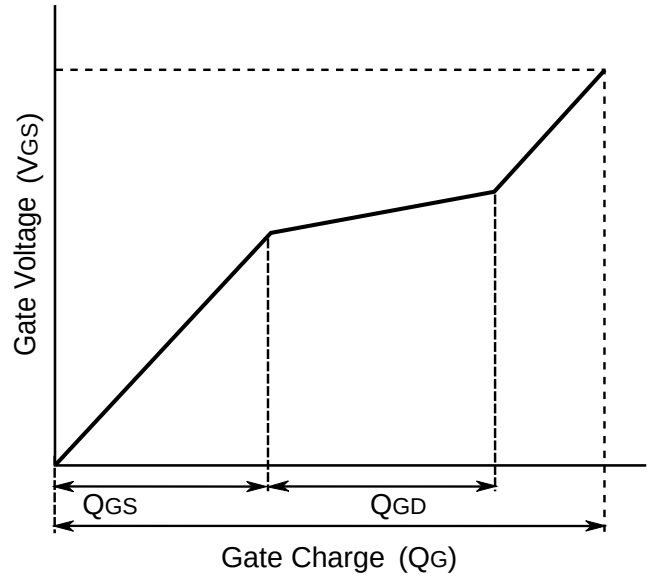
$T_j = 25^\circ C; V_{GS} = -5/+20V; I_{DS} = 2 A; L = 1000.0\mu H$



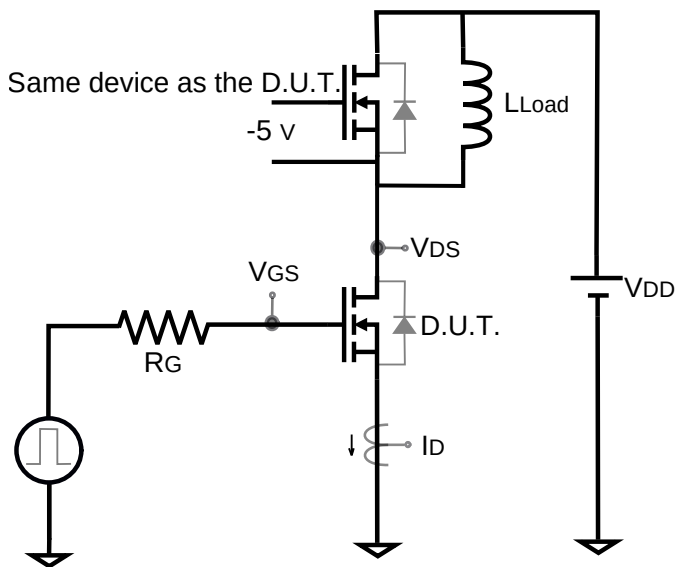
Gate Charge Circuit



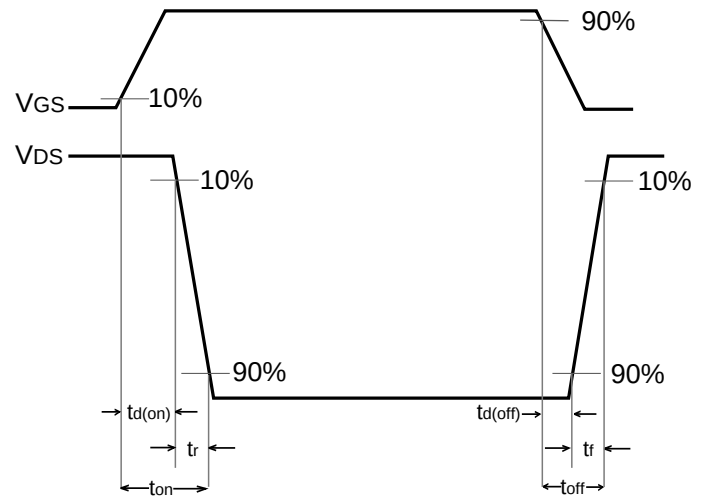
Gate Charge Waveform



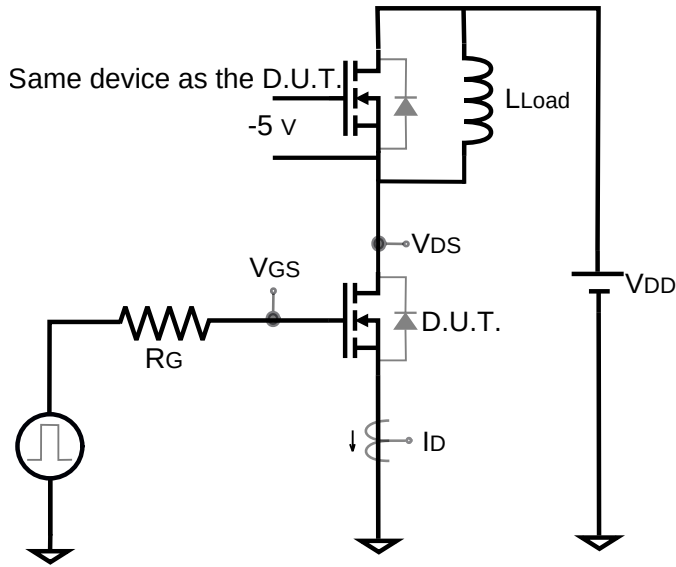
Switching Time Circuit



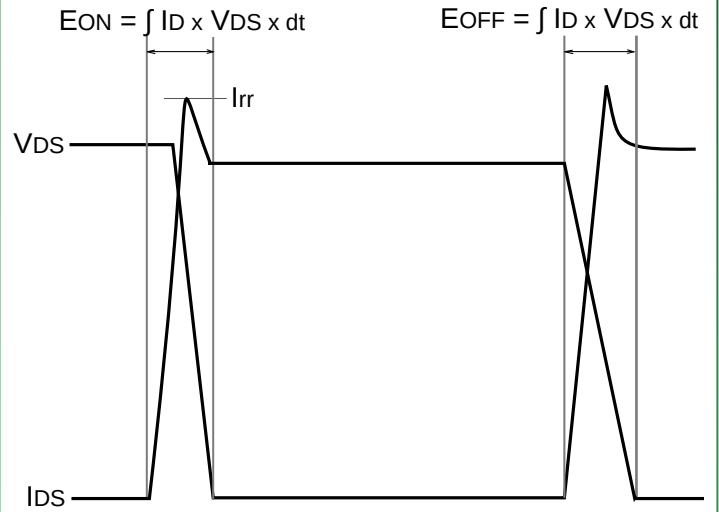
Switching Time Waveform



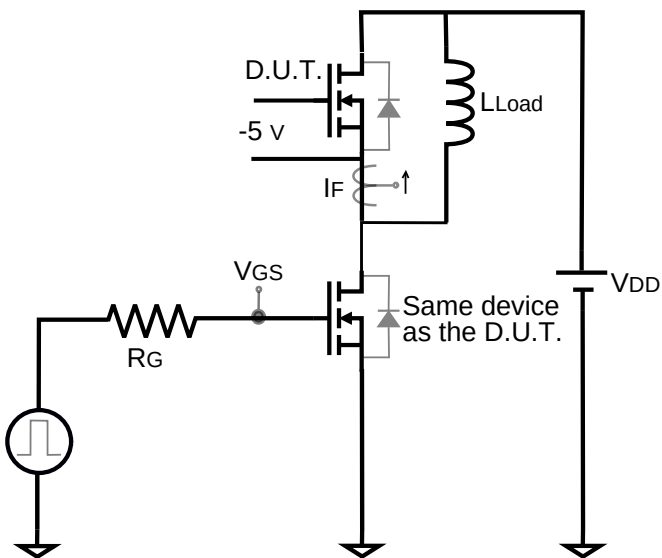
Switching Energy Circuit



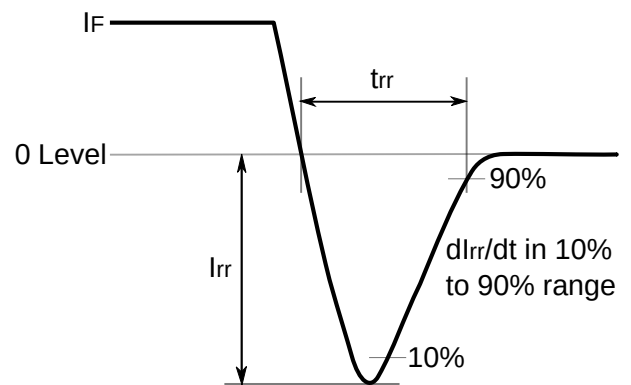
Switching Energy Waveform



Reverse Recovery Circuit

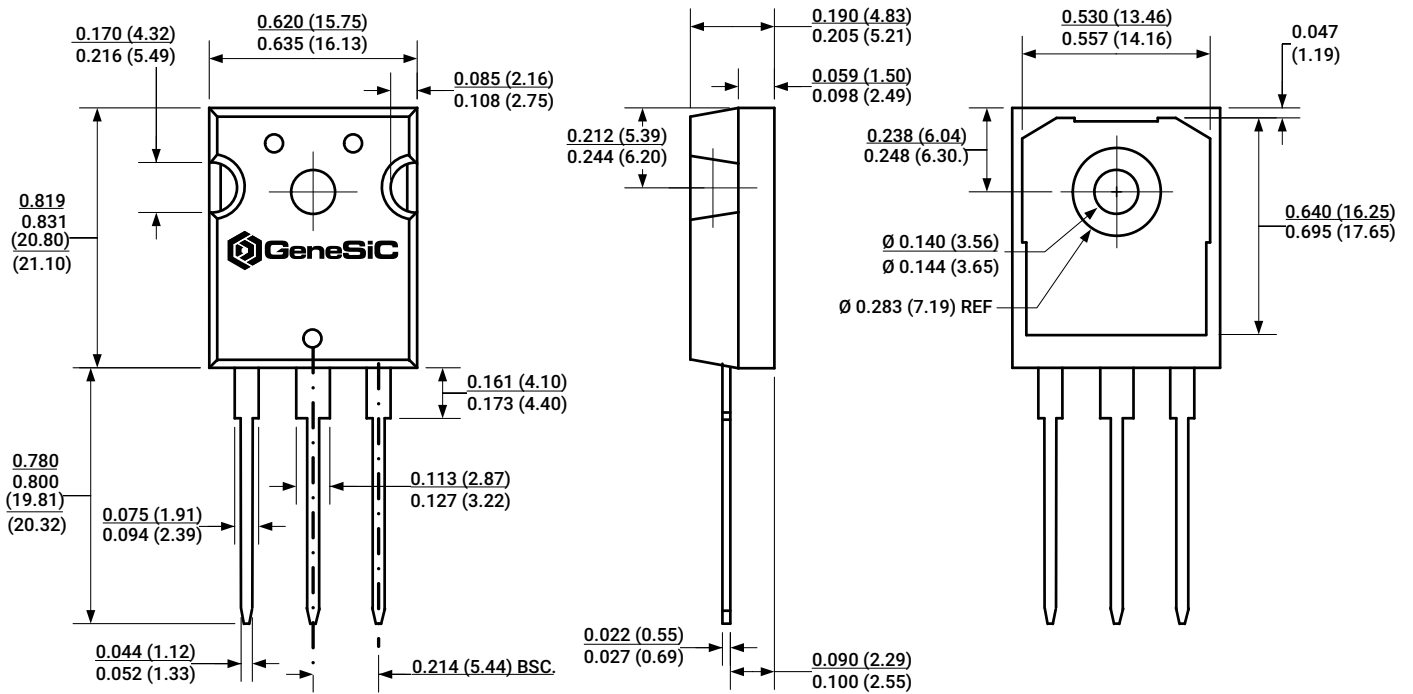


Reverse Recovery Waveform

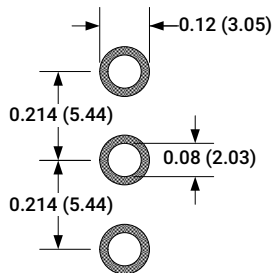


Package Dimensions

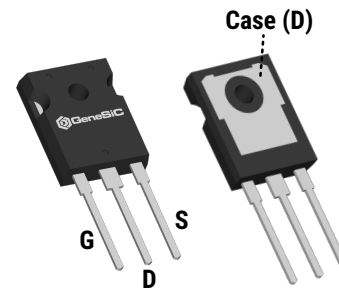
TO-247-3 Package Outline



Recommended Solder Pad Layout



Package View



NOTE

1. CONTROLLED DIMENSION IS INCH. DIMENSION IN BRACKET IS MILLIMETER.
2. DIMENSIONS DO NOT INCLUDE END FLASH, MOLD FLASH, MATERIAL PROTRUSIONS.

Compliance

RoHS Compliance

The levels of RoHS restricted materials in this product are below the maximum concentration values (also referred to as the threshold limits) permitted for such substances, or are used in an exempted application, in accordance with EU Directive 2011/65/EC (RoHS 2), as adopted by EU member states on January 2, 2013 and amended on March 31, 2015 by EU Directive 2015/863. RoHS Declarations for this product can be obtained from your GeneSiC representative.

REACH Compliance

REACH substances of high concern (SVHCs) information is available for this product. Since the European Chemical Agency (ECHA) has published notice of their intent to frequently revise the SVHC listing for the foreseeable future, please contact a GeneSiC representative to insure you get the most up-to-date REACH SVHC Declaration. REACH banned substance information (REACH Article 67) is also available upon request.

Disclaimer

GeneSiC Semiconductor, Inc. reserves right to make changes to the product specifications and data in this document without notice. GeneSiC disclaims all and any warranty and liability arising out of use or application of any product. No license, express or implied to any intellectual property rights is granted by this document.

Unless otherwise expressly indicated, GeneSiC products are not designed, tested or authorized for use in life-saving, medical, aircraft navigation, communication, air traffic control and weapons systems, nor in applications where their failure may result in death, personal injury and/or property damage.

Related Links

- SPICE Models: https://www.genesicsemi.com/sic-mosfet/G2R1000MT17D/G2R1000MT17D_SPICE.zip
- PLECS Models: https://www.genesicsemi.com/sic-mosfet/G2R1000MT17D/G2R1000MT17D_PLECS.zip
- CAD Models: https://www.genesicsemi.com/sic-mosfet/G2R1000MT17D/G2R1000MT17D_3D.zip
- Gate Driver Reference: <https://www.genesicsemi.com/technical-support>
- Evaluation Boards: <https://www.genesicsemi.com/technical-support>
- Reliability: <https://www.genesicsemi.com/reliability>
- Compliance: <https://www.genesicsemi.com/compliance>
- Quality Manual: <https://www.genesicsemi.com/quality>

Revision History

- Rev 21/May: Updated minimum Vth to 2V
- Supersedes: Rev 20/Jun, Rev 20/Aug, Rev 21/Feb



www.genesicsemi.com/sic-mosfet/