

High Performance Generation 5.0 Schottky Rectifier, 10 A

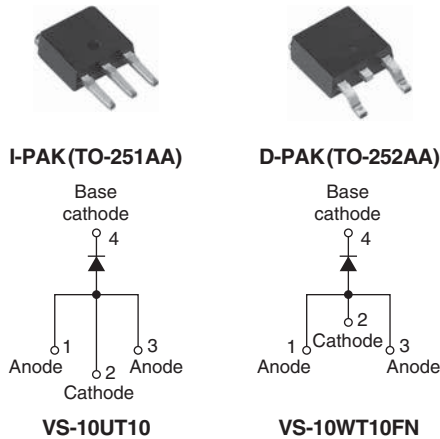

FEATURES

- 175 °C high performance Schottky diode
- Very low forward voltage drop
- Extremely low reverse leakage
- Optimized V_F vs. I_R trade off for high efficiency
- Increased ruggedness for reverse avalanche capability
- RBSOA available
- Negligible switching losses
- Submicron trench technology
- Compliant to RoHS Directive 2002/95/EC
- Designed and qualified according to JEDEC-JESD47

RoHS
COMPLIANT

PRODUCT SUMMARY	
Package	I-PAK (TO-251AA), D-PAK (TO-252AA)
$I_{F(AV)}$	10 A
V_R	100 V
V_F at I_F	0.66 V
I_{RM} max.	4 mA at 125 °C
T_J max.	175 °C
Diode variation	Single die
E_{AS}	54 mJ

APPLICATIONS

- High efficiency SMPS
- High frequency switching
- Output rectification
- Reverse battery protection
- Freewheeling
- DC/DC systems
- Increased power density systems

MAJOR RATINGS AND CHARACTERISTICS			
SYMBOL	CHARACTERISTICS	VALUES	UNITS
V_{RRM}		100	V
V_F	10 Apk, $T_J = 125$ °C (typical)	0.615	V
T_J	Range	- 55 to 175	°C

VOLTAGE RATINGS				
PARAMETER	SYMBOL	TEST CONDITIONS	VS-10UT10 VS-10WT10FN	UNITS
Maximum DC reverse voltage	V_R	$T_J = 25$ °C	100	V

ABSOLUTE MAXIMUM RATINGS					
PARAMETER	SYMBOL	TEST CONDITIONS		VALUES	UNITS
Maximum average forward current	$I_{F(AV)}$	50 % duty cycle at $T_C = 159$ °C, rectangular waveform		10	A
Maximum peak one cycle non-repetitive surge current	I_{FSM}	5 μ s sine or 3 μ s rect. pulse	Following any rated load condition and with rated V_{RRM} applied (1)	610	A
		10 ms sine or 6 ms rect. pulse		110	
Non-repetitive avalanche energy	E_{AS}	$T_J = 25$ °C, $I_{AS} = 3$ A, $L = 12$ mH		54	mJ
Repetitive avalanche current	I_{AR}	Limited by frequency of operation and time pulse duration so that $T_J < T_J$ max. I_{AS} at T_J max. as a function of time pulse (see fig. 8)		I_{AS} at T_J max.	A

Note

(1) Measured connecting 2 anode pins



ELECTRICAL SPECIFICATIONS								
PARAMETER	SYMBOL	TEST CONDITIONS	TYP.	MAX.	UNITS			
Forward voltage drop	$V_{FM}^{(1)(2)}$	5 A	0.630	-	V			
		10 A				$T_J = 25\text{ }^\circ\text{C}$	0.735	0.810
		20 A					0.840	0.890
		5 A	$T_J = 125\text{ }^\circ\text{C}$	0.530			-	
		10 A		0.615		0.660		
		20 A		0.730		0.770		
Reverse leakage current	$I_{RM}^{(1)}$	$T_J = 25\text{ }^\circ\text{C}$	-	50	μA			
		$T_J = 125\text{ }^\circ\text{C}$	-	4	mA			
Junction capacitance	C_T	$V_R = 5\text{ V}_{DC}$ (test signal range 100 kHz to 1 MHz), $25\text{ }^\circ\text{C}$	400	-	pF			
Series inductance	L_S	Measured lead to lead 5 mm from package body	8.0	-	nH			
Maximum voltage rate of change	dV/dt	Rated V_R	-	10 000	V/ μs			

Notes

- (1) Pulse width < 300 μs , duty cycle < 2 %
- (2) Only 1 anode pin connected

THERMAL - MECHANICAL SPECIFICATIONS				
PARAMETER	SYMBOL	TEST CONDITIONS	VALUES	UNITS
Maximum junction and storage temperature range	T_J, T_{Stg}		- 55 to 175	$^\circ\text{C}$
Maximum thermal resistance, junction to case	R_{thJC}	DC operation	2	$^\circ\text{C/W}$
Typical thermal resistance, case to heatsink	R_{thCS}		0.3	
Approximate weight			0.3	g
			0.01	oz.
Marking device		Case style I-PAK	10UT10	
		Case style D-PAK	10WT10FN	

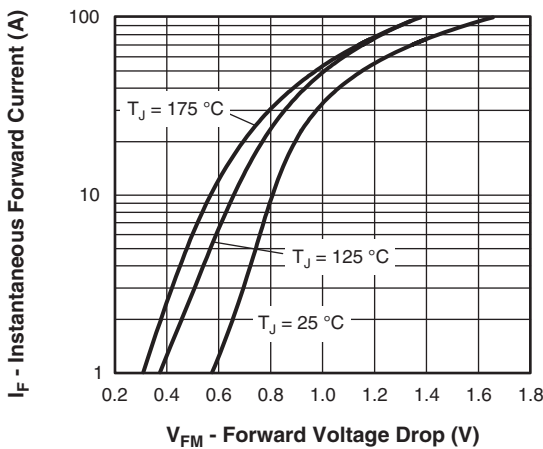

Fig. 1 - Maximum Forward Voltage Drop Characteristics

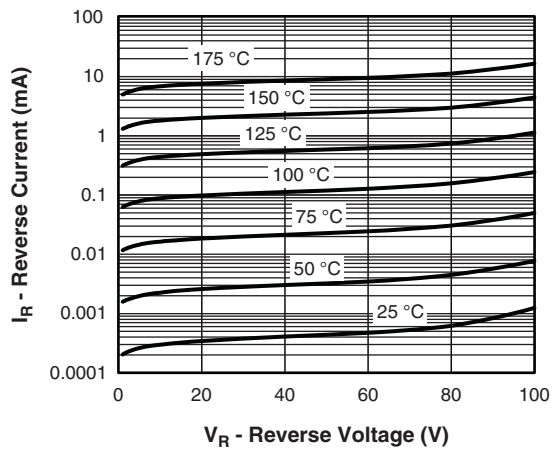

Fig. 2 - Typical Values of Reverse Current vs. Reverse Voltage

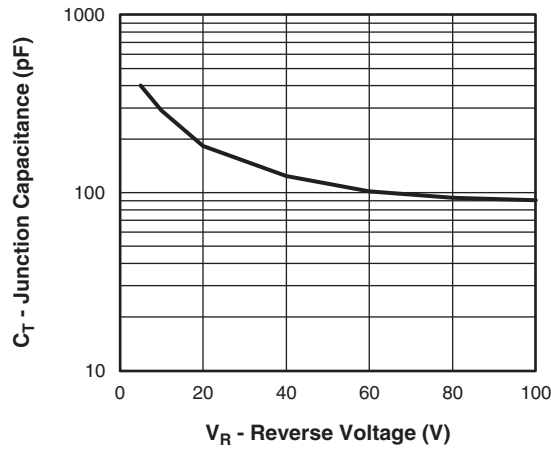

Fig. 3 - Typical Junction Capacitance vs. Reverse Voltage

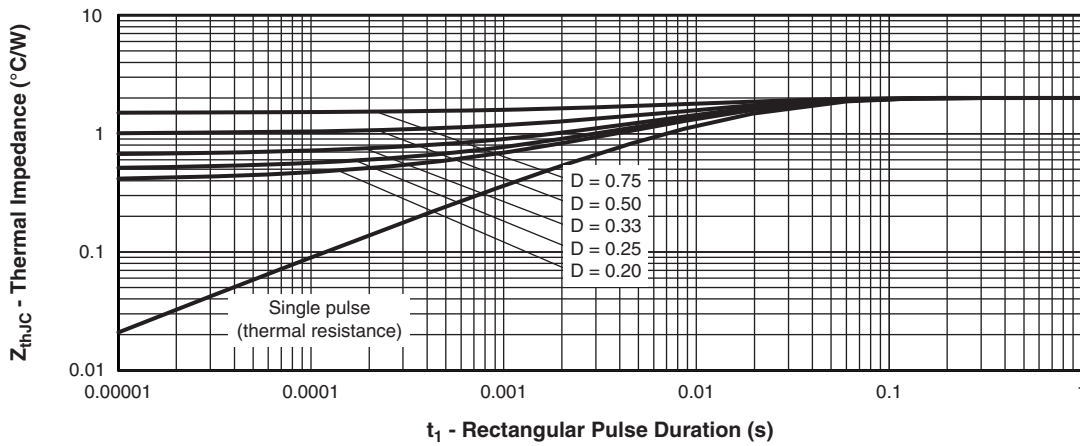

Fig. 4 - Maximum Thermal Impedance Z_{thJC} Characteristics

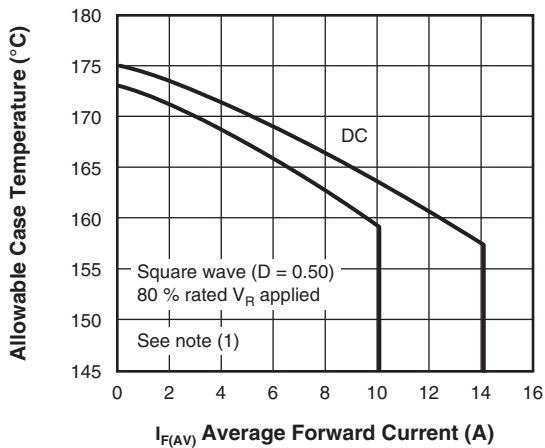

Fig. 5 - Maximum Allowable Case Temperature vs. Average Forward Current

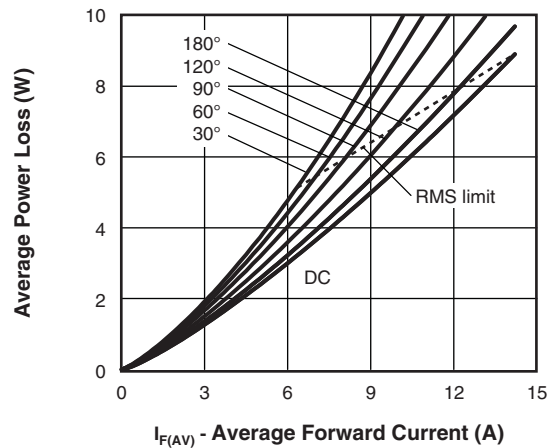

Fig. 6 - Forward Power Loss Characteristics

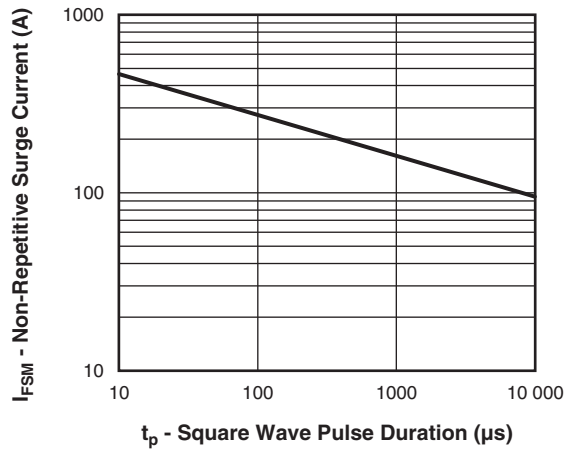

Fig. 7 - Maximum Non-Repetitive Surge Current

Note

- (1) Formula used: $T_C = T_J - (P_d + P_{d_{REV}}) \times R_{thJC}$;
 P_d = Forward power loss = $I_{F(AV)} \times V_{FM}$ at $(I_{F(AV)}/D)$ (see fig. 6);
 $P_{d_{REV}}$ = Inverse power loss = $V_{R1} \times I_R (1 - D)$; I_R at $V_{R1} = 80\%$ rated V_R

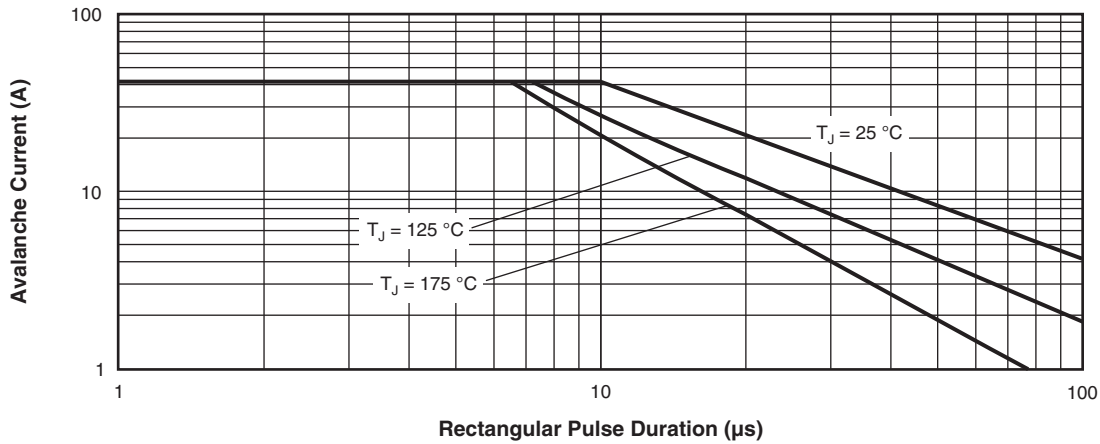

Fig. 8 - Reverse Bias Safe Operating Area (Avalanche Current vs. Rectangular Pulse Duration)

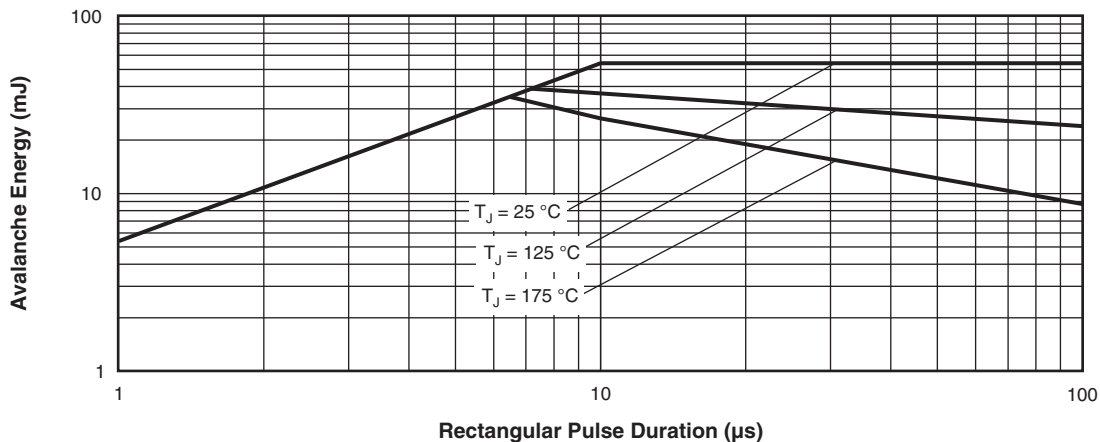
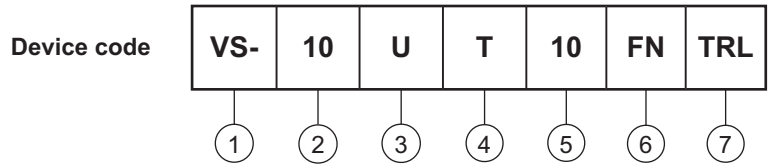

Fig. 9 - Reverse Bias Safe Operating Area (Avalanche Energy vs. Rectangular Pulse Duration)



ORDERING INFORMATION TABLE



- 1** - Vishay Semiconductors product
- 2** - Current rating (10 A)
- 3** - Package:
 - U = I-PAK
 - W = D-PAK
- 4** - T = Trench
- 5** - Voltage code (100 V)
- 6** - TO-252AA (D-PAK)
- 7** - D-PAK, I-PAK:
 - None = Tube (75 pieces)
 - D-PAK only:
 - TR = Tape and reel
 - TRL = Tape and reel (left oriented)
 - TRR = Tape and reel (right oriented)

LINKS TO RELATED DOCUMENTS		
Dimensions	I-PAK (TO-251AA)	www.vishay.com/doc?95024
	D-PAK (TO-252AA)	www.vishay.com/doc?95448
Part marking information	I-PAK (TO-251AA)	www.vishay.com/doc?95025
	D-PAK (TO-252AA)	www.vishay.com/doc?95059
Packaging information		www.vishay.com/doc?95033
SPIICE model		www.vishay.com/doc?95026

I-PAK - S

DIMENSIONS FOR I-PAK - S in millimeters

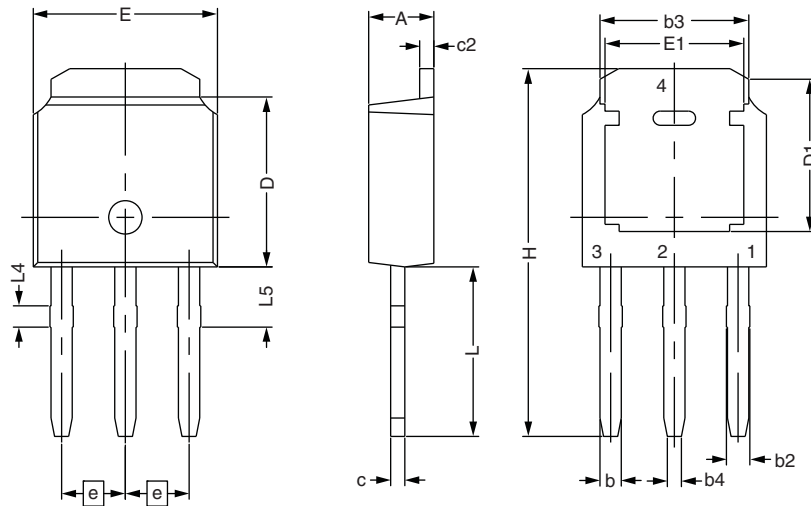

SYMBOL	DIMENSIONAL REQUIREMENTS		
	MIN.	NOM.	MAX.
E	6.40	6.60	6.70
L	3.98	4.13	4.28
L4	0.66	0.76	0.86
L5	1.96	2.16	2.36
D	6.00	6.10	6.20
H	11.05	11.25	11.45
b	0.64	0.76	0.88
b2	0.77	0.84	1.14
b3	5.21	5.34	5.46
b4	0.41	0.51	0.61
e	2.286 BSC		
A	2.20	2.30	2.38
c	0.40	0.50	0.60
c2	0.40	0.50	0.60
D1	5.30	-	-
E1	4.40	-	-



Disclaimer

ALL PRODUCT, PRODUCT SPECIFICATIONS AND DATA ARE SUBJECT TO CHANGE WITHOUT NOTICE TO IMPROVE RELIABILITY, FUNCTION OR DESIGN OR OTHERWISE.

Vishay Intertechnology, Inc., its affiliates, agents, and employees, and all persons acting on its or their behalf (collectively, "Vishay"), disclaim any and all liability for any errors, inaccuracies or incompleteness contained in any datasheet or in any other disclosure relating to any product.

Vishay makes no warranty, representation or guarantee regarding the suitability of the products for any particular purpose or the continuing production of any product. To the maximum extent permitted by applicable law, Vishay disclaims (i) any and all liability arising out of the application or use of any product, (ii) any and all liability, including without limitation special, consequential or incidental damages, and (iii) any and all implied warranties, including warranties of fitness for particular purpose, non-infringement and merchantability.

Statements regarding the suitability of products for certain types of applications are based on Vishay's knowledge of typical requirements that are often placed on Vishay products in generic applications. Such statements are not binding statements about the suitability of products for a particular application. It is the customer's responsibility to validate that a particular product with the properties described in the product specification is suitable for use in a particular application. Parameters provided in datasheets and/or specifications may vary in different applications and performance may vary over time. All operating parameters, including typical parameters, must be validated for each customer application by the customer's technical experts. Product specifications do not expand or otherwise modify Vishay's terms and conditions of purchase, including but not limited to the warranty expressed therein.

Except as expressly indicated in writing, Vishay products are not designed for use in medical, life-saving, or life-sustaining applications or for any other application in which the failure of the Vishay product could result in personal injury or death. Customers using or selling Vishay products not expressly indicated for use in such applications do so at their own risk. Please contact authorized Vishay personnel to obtain written terms and conditions regarding products designed for such applications.

No license, express or implied, by estoppel or otherwise, to any intellectual property rights is granted by this document or by any conduct of Vishay. Product names and markings noted herein may be trademarks of their respective owners.

Material Category Policy

Vishay Intertechnology, Inc. hereby certifies that all its products that are identified as RoHS-Compliant fulfill the definitions and restrictions defined under Directive 2011/65/EU of The European Parliament and of the Council of June 8, 2011 on the restriction of the use of certain hazardous substances in electrical and electronic equipment (EEE) - recast, unless otherwise specified as non-compliant.

Please note that some Vishay documentation may still make reference to RoHS Directive 2002/95/EC. We confirm that all the products identified as being compliant to Directive 2002/95/EC conform to Directive 2011/65/EU.

Vishay Intertechnology, Inc. hereby certifies that all its products that are identified as Halogen-Free follow Halogen-Free requirements as per JEDEC JS709A standards. Please note that some Vishay documentation may still make reference to the IEC 61249-2-21 definition. We confirm that all the products identified as being compliant to IEC 61249-2-21 conform to JEDEC JS709A standards.