



Part Number: D3I0102N

Electrical Specifications

Frequency Range (GHz):	1.0 – 2.0
Isolation (dB):	18 MIN
Insertion Loss (dB):	0.5 MAX
VSWR:	1.3:1 MIN
Forward Power (W):	50 AVG 75 PK
Reflective Power (W):	10 AVG

Mechanical/Environmental Specifications

Connector Type:	Type-N
Connector Body:	Nickel plated brass
Connector Pin:	Gold plated copper
Load Body:	Brass
Magnetic Shunt:	Nickel plated CRS
Operational Temp:	10°C to +55°C
Weight (oz)	15 MAX

D3I0102N Dimensions

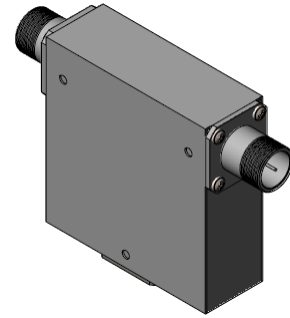
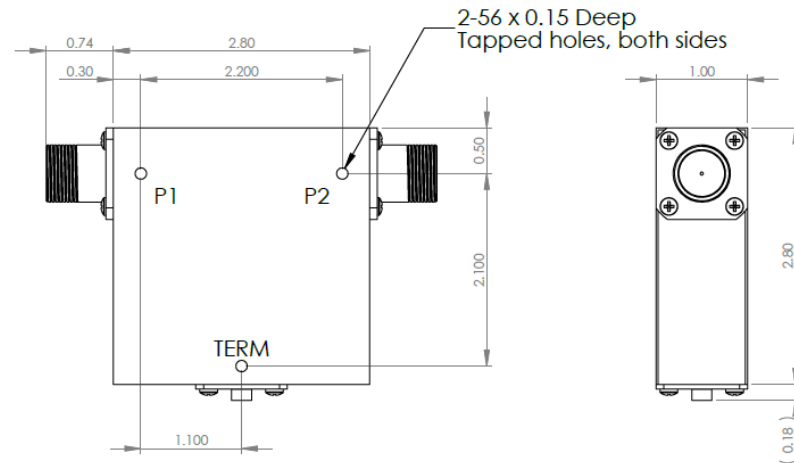

D3I0102N-3 Dimensions

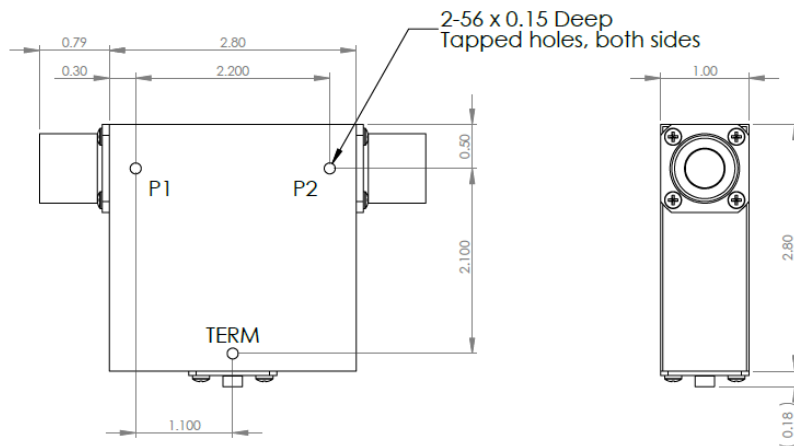

Dimensions are in inches
Tolerance

XX	±0.03
XXX	±0.010

Type of Device	PN Suffix	Connector Configuration Input / Output	PN Example
Single and Dual Junction Isolator, 2-Port Device Input / Output	N/A	Female / Female	D3I0102N
	-1	Male / Female	D3I0102N-1
	-2	Female / Male	D3I0102N-2
	-3	Male / Male	D3I0102N-3



MEASURED DATA

Part Number: D3I0102N, +25°C

