

M / P SERIES STEP MOTORS

- Size 17
- Size 23
- Size 34
- Size 42



M / P SERIES STEP MOTORS



Construction
Model Numbers
Options

MS17HD
1.8°
Size 17

ML23HS
/ PL23HS
1.8°
Size 23

ML34HD
/ PL34HD
1.8°
Size 34

ML42HS
/ PL42HS
1.8°
Size 42

Technical
& Conversion
Charts

Index

PowerPlus Technology.....	3
M / P Series Step Motors.....	4
Model Number System.....	5
Custom Motors.....	6
Size 17 - 1.8° - MS17HD Series.....	7
Size 23 - 1.8° - ML23HS / PL23HS Series.....	11
Size 34 - 1.8° - ML34HD / PL34HD Series.....	15
Size 42 - 1.8° - ML42HS / PL42HS Series.....	19
Technical Information.....	23
Conversion Factors.....	24

MOONS' also offers NEMA size 8, 11, 14 and 24 motors, and 3 phase step motors.

PowerPlus Technology

Size 23 and larger motors are available with MOONS' PowerPlus technology. This technology provides 25% to 40% more torque across the entire speed range of the motor. The increased torque is a result of higher motor efficiency, and is available without increasing the drive voltage or current.

■ Typical Applications

Machine Upgrades

Changing existing machines to PowerPlus motors can be a quick path to new models with higher performance. Because the motor, drive and mechanical parts remain the same, benefits include:

- **Faster new product introduction**
- **Reduced engineering costs**
- **Easy production phase in**
- **Reduced spare parts inventory**

Correct stalling problems with existing machines

Problems with occasional machine stalling are often due to unexpected field conditions that require more torque. These include: low temperature, dirt, and customers using machines in unexpected ways. Using PowerPlus motors can be a quick effective solution.

Overcome drive or power supply limitations in new designs

Often a higher current drive or higher voltage power supply can provide needed extra torque. However, in many designs the drive current cannot be increased without switching to a larger, more expensive drive. Increasing drive voltage can be impractical, expensive, or may not be allowed for safety reasons. In these cases using PowerPlus motors can be especially useful.

Conventional Motor

Some of the flux linking the rotor to the stator is outside the stator teeth. This stray flux adds little to motor torque.

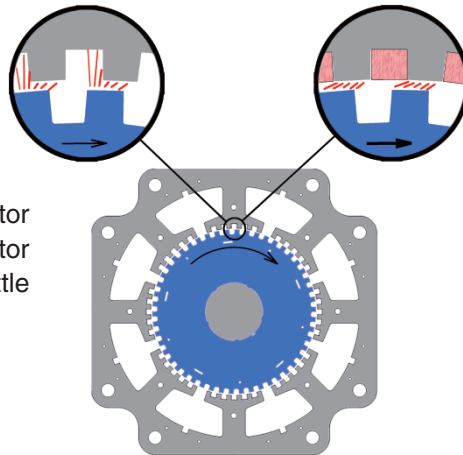

PowerPlus Technology

Magnets placed between the stator teeth redirect most of the stray flux into the stator teeth. This produces additional torque with the same input power.

M / P Series Step Motors

■ M / P Series step motors from MOONS' include a number of improvements for greater performance and value:

- Size 17, 23, 34..... and now size 42 motors
- PowerPlus technology: boosts efficiency and performance at all speeds
- Lower inertia rotors provide faster acceleration
- High voltage insulation for use with high voltage, high performance drives
- Low loss stators have better high speed performance
- Standard windings with high fill for more low speed torque
- Updated model numbering includes a wider range of windings and standard options

■ Basic Structure

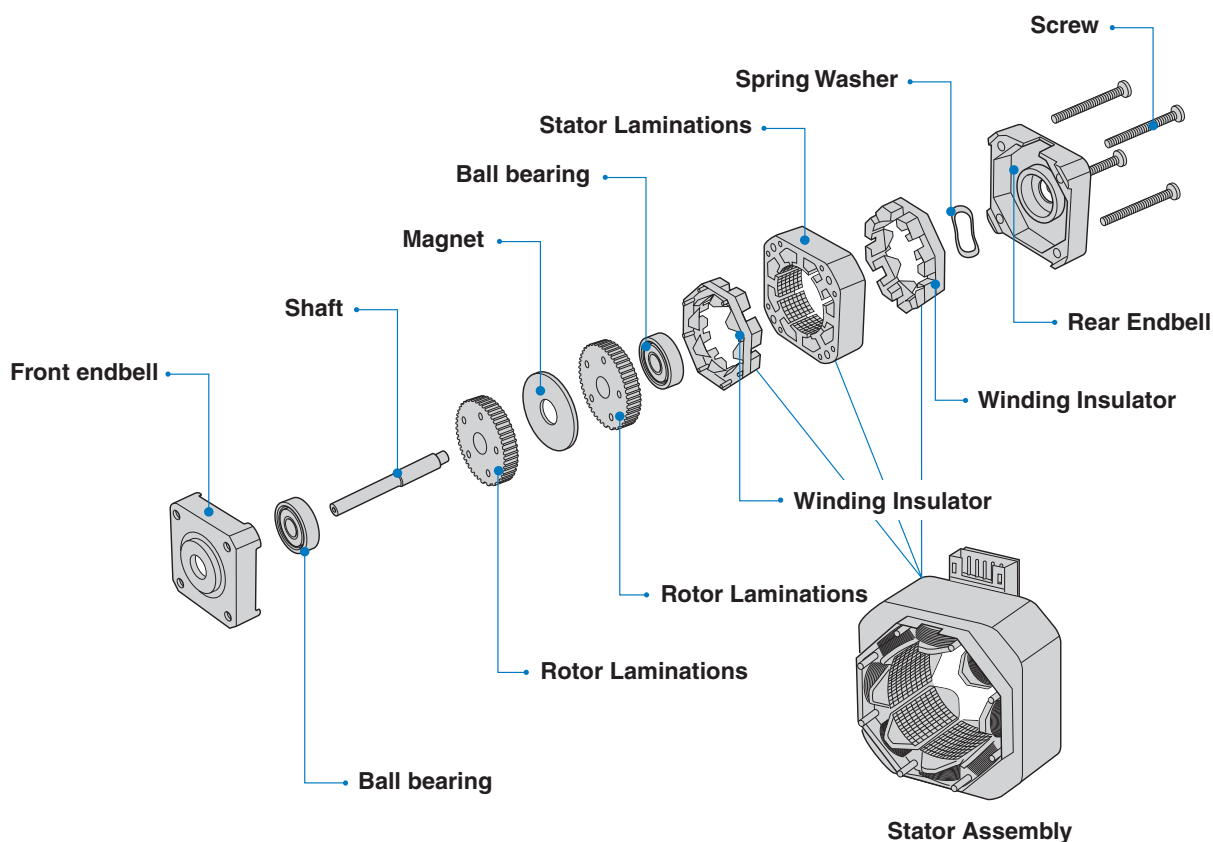

Construction
Model Numbers
Options

MS17HD
1.8°
Size 17

ML23HS
/ PL23HS
1.8°
Size 23

ML34HD
/ PL34HD
1.8°
Size 34

ML42HS
/ PL42HS
1.8°
Size 42

Technical
& Conversion
Charts

M / P Series Model Numbering System

M S 17 HD 2 P 4 040 -M

Stator - Series

- M** Standard Step Motor
- P** PowerPlus Step Motor

Rotor

- S** Standard Inertia Size 17
- L** Lower Inertia Size 23, 34, 42

Frame Size

17, 23, 34, 42

Motor Technology

HD or HS Hybrid Step Motor, 2 Phase 1.8 degree

Length Code

Traditional Stacks 1/2 1 2 3

MS17HD	Length Code	4	2	6	B
	Basic Motor Length (Max. mm)	34.3	39.8	48.3	62.8
ML23HS	Length Code	0	8	A	
	Basic Motor Length (Max. mm)	39	55	77	
ML34HD	Length Code		0	1	2
	Basic Motor Length (Max. mm)		67	97	126
ML42HS	Length Code		0	2	3
	Basic Motor Length (Max. mm)		100	151	202

Connection Construction / IP Rating

- L** Leads IP40
- P** Plug In Connector - Standard IP40

Number of connections / Winding Type

- 4** Bipolar
- 6** Unipolar (can be used bipolar)
- 8** Can be connected any way

Winding Current

Current rating x 100. 050 = 0.5 amps, 500 = 5 amps
X## for 11 to 19 amps: X10= 11 amps, X40 = 14 amps

Options

- Omit** No Options
- E** Standard English rear shaft
- M** Standard Metric rear shaft

Construction
Model Numbers
Options

MS17HD
1.8°
Size 17

ML23HS
/ PL23HS
1.8°
Size 23

ML34HD
/ PL34HD
1.8°
Size 34

ML42HS
/ PL42HS
1.8°
Size 42

Technical
& Conversion
Charts

Custom Motors

■ **MOONS' provides motors to meet the needs of many applications. Common modifications include:**

- Corrosion resistant motors. These are often used in outdoor equipment where humidity and temperature changes can cause corrosion.
- Sealed motors to keep out dust and water
- Special shaft sizes and features
- Pulleys, gears and couplings mounted on the shaft
- Encoders and other feedback devices
- Special lead lengths or cables, with many different connectors

■ **Press Fit Pulley & Gears**

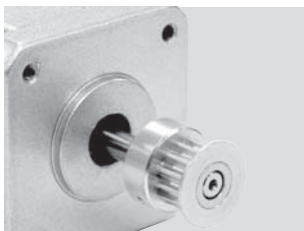

Metal Pulley



Plastic Pulley

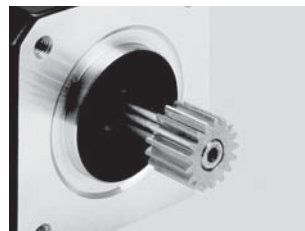

Gear

■ **Shaft Options**



Worm Shaft



Hollow Shaft

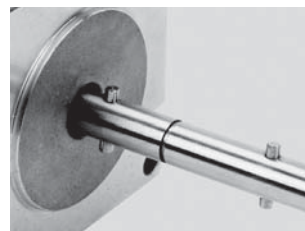

Dowel



Single Flat



Double Flat



Key Way

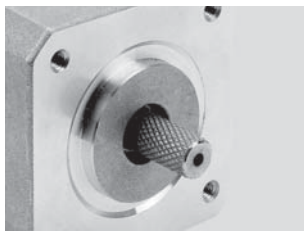

Knurl

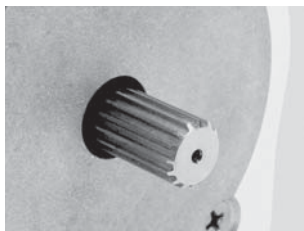

Hobbed Gear

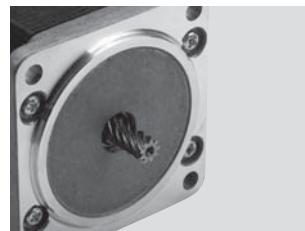

Helical Cut

Construction
Model Numbers
Options

MS17HD
1.8"
Size 17

ML23HS
/ PL23HS
1.8"
Size 23

ML34HD
/ PL34HD
1.8"
Size 34

ML42HS
/ PL42HS
1.8"
Size 42

Technical
& Conversion
Charts

MS17HD Series:1.8° - Size 17

- Phases 2
- Steps / Revolution 200
- Step Accuracy ±5%
- Shaft Load (20,000 Hours at 1000 RPM)
 - Axial 25 N (5.6 Lbs.) Push
 - 65 N (15 Lbs.) Pull
 - Radial 29 N (6.5 Lbs.) At Flat Center
- IP Rating 40
- Approvals RoHS
- Operating Temp. -20°C to +40°C
- Insulation Class B, 130°C
- Insulation Resistance 100 MegOhms



MS17HD 4 P 4 040 -M		Options
Basic Motor Length (Max)		Omit No Options
4	34.3 mm (1.35")	-M 5 mm diameter rear shaft with encoder mounting holes
2	39.8 mm (1.57")	
6	48.3 mm (1.90")	
B	62.8 mm (2.47")	
Electrical Connection		Winding
P	Plug-In Connector	### Current rating x 100
Number of Connections		
4	4 Lead - Bipolar	
6	6 Lead - Unipolar (or Bipolar)	

■ Dimensions: mm (in)

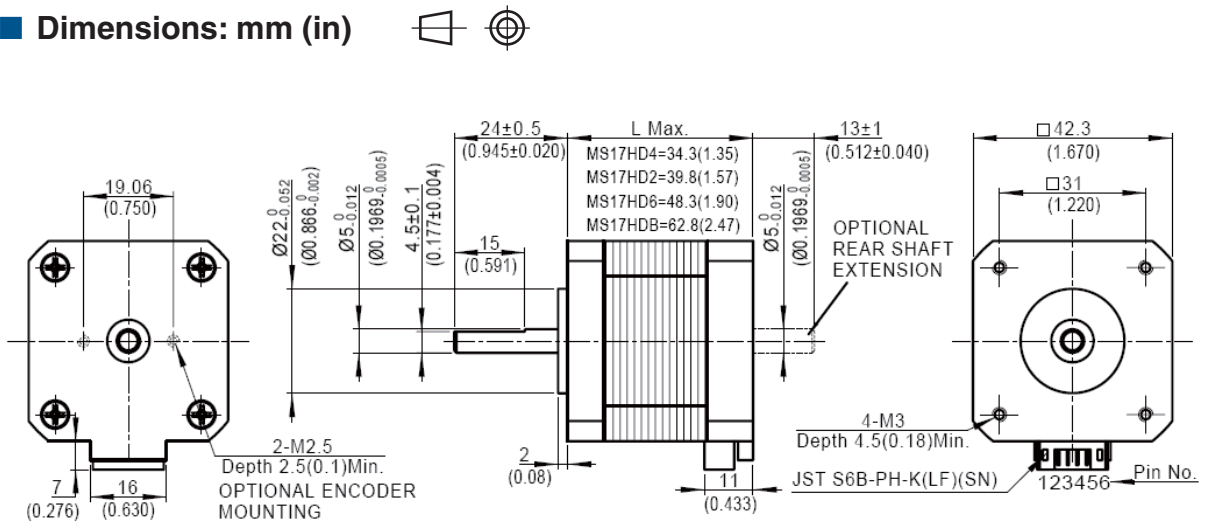

ML23HS / PL23HS 1.8° Size 23

ML34HD / PL34HD 1.8° Size 34

ML42HS / PL42HS 1.8° Size 42

Technical & Conversion Charts

MS17HD - 4 Lead Bi-Polar

Length	Model Number	Connect P=Plug L=Leads	Mounted			Winding		Detent Torque		Rotor Inertia		Motor Weight	
			Rated Current	Holding Torque		Ohms	mH	mNm	oz-in	g cm2	oz-in2	kg	Lbs
			Amps	Nm Typ.	oz-in Typ.	±10% @20°C	Typ.						
34.3 mm (1.35 in.) Short	^ MS17HD4P4040	p	0.4	0.34	48	30	51	12	1.7	38	0.21	0.21	0.46
	^ MS17HD4P4065	p	0.65	0.32	45	8.7	15.4						
	^ MS17HD4P4100	p	1	0.33	47	4.2	7.5						
	^ MS17HD4P4150	p	1.5	0.32	45	1.7	2.9						
39.8 mm (1.57 in.) 1 Stack	^ MS17HD2P4040	p	0.4	0.48	68	24	56	15	2.1	57	0.31	0.28	0.62
	^ MS17HD2P4100	p	1	0.48	68	3.9	8.9						
	^ MS17HD2P4150	p	1.5	0.50	71	1.98	4.3						
	^ MS17HD2P4200	p	2	0.48	68	1.04	2.2						
48.3 mm (1.9 in.) 2 Stack	^ MS17HD6P4050	p	0.5	0.67	95	24	53	25	3.5	82	0.45	0.36	0.79
	^ MS17HD6P4100	p	1	0.63	89	4.9	11.5						
	^ MS17HD6P4150	p	1.5	0.62	88	2.2	4.9						
	^ MS17HD6P4200	p	2	0.63	89	1.3	2.9						
62.8 mm (2.47 in.) 3 Stack	^ MS17HDBP4100	p	1	0.82	120	5.6	14.6	30	4.2	123	0.67	0.6	1.3
	^ MS17HDBP4150	p	1.5	0.88	120	3	7.7						
	^ MS17HDBP4200	p	2	0.83	120	1.49	3.8						

^ Preferred model

MS17HD - 6 Lead Uni-Polar

Length	Model Number	Connect P=Plug L=Leads	Mounted			Winding		Detent Torque		Rotor Inertia		Motor Weight	
			Rated Current	Holding Torque		Ohms	mH	mNm	oz-in	g cm2	oz-in2	kg	Lbs
			Amps	Nm Typ.	oz-in Typ.	±10% @20°C	Typ.						
34.3 mm (1.35 in.) Short	MS17HD4P6038	p	0.38	0.26	37	31	27	12	1.7	38	0.21	0.21	0.46
	MS17HD4P6085	p	0.85	0.24	34	5.1	4.5						
	MS17HD4P6120	p	1.2	0.25	35	2.9	2.5						
39.8 mm (1.57 in.) 1 Stack	MS17HD2P6040	p	0.4	0.38	54	28	31	15	2.1	57	0.31	0.28	0.62
	MS17HD2P6085	p	0.85	0.38	54	6	6.7						
	MS17HD2P6130	p	1.3	0.38	54	2.5	2.8						
48.3 mm (1.9 in.) 2 Stack	MS17HD6P6040	p	0.4	0.48	68	29	33	25	3.5	82	0.45	0.36	0.79
	MS17HD6P6080	p	0.8	0.49	69	7.6	8.6						
	MS17HD6P6130	p	1.3	0.51	72	3.2	3.6						
	MS17HD6P6200	p	2	0.50	71	1.3	1.4						

^ Preferred model

Mating Connector With Leads (order separately) Dimensions: mm (in)

4 Lead Part Number 4634 1402 00723

6 Lead Part Number 4634 1402 00922

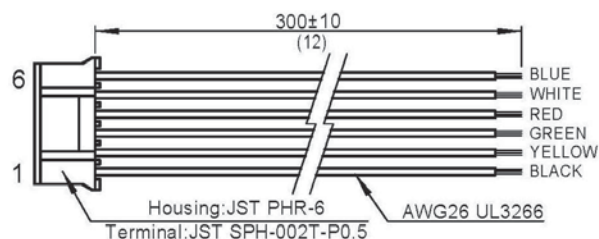
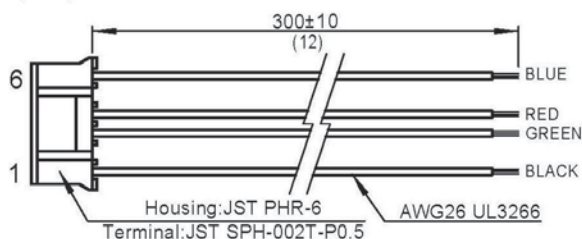

Construction
Model Numbers
Options

MS17HD
1.8°
Size 17

ML23HS
/ PL23HS
1.8°
Size 23

ML34HD
/ PL34HD
1.8°
Size 34

ML42HS
/ PL42HS
1.8°
Size 42

Technical
& Conversion
Charts

Dynamic Torque Curves

MS17HD4 - Bipolar

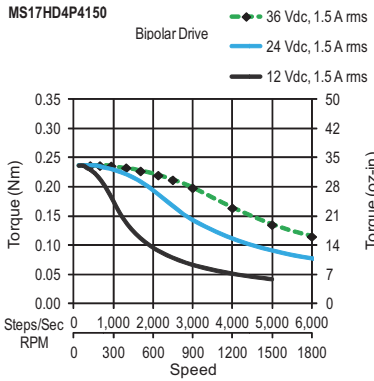
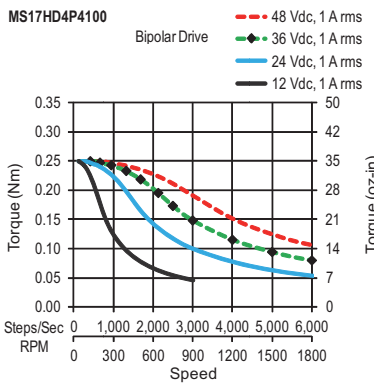
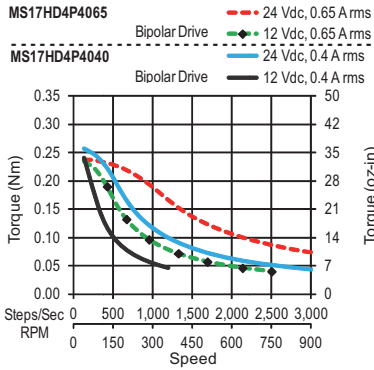

MS17HD2 - Bipolar

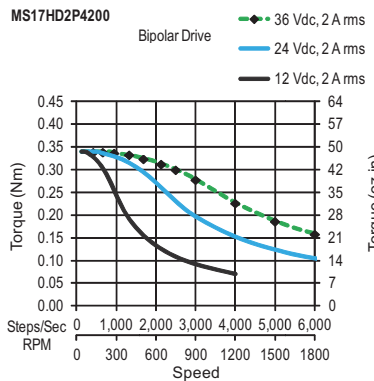
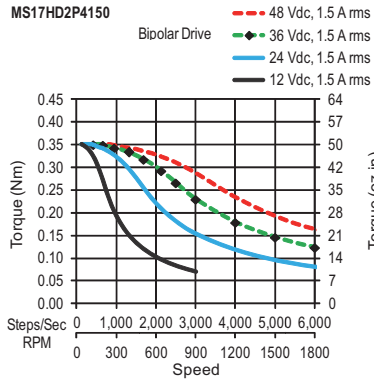
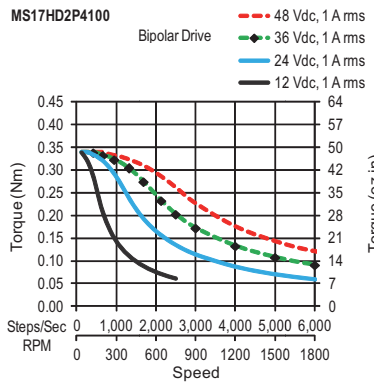
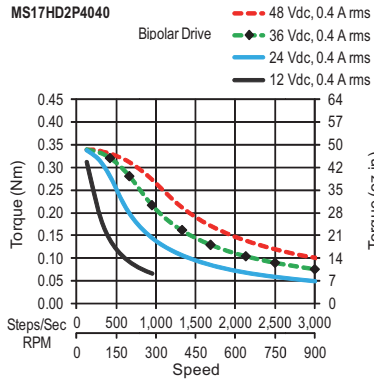

MS17HD6 - Bipolar

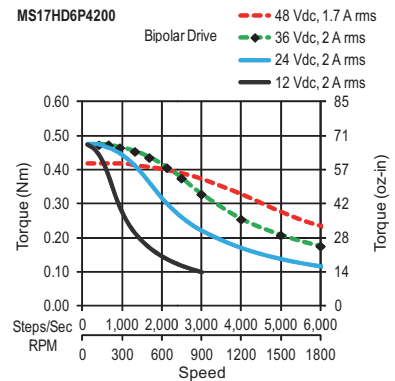
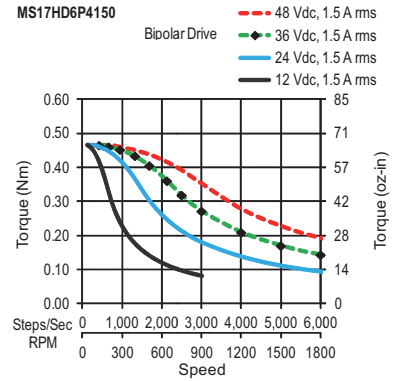
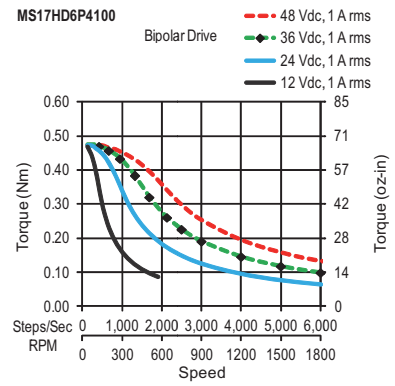
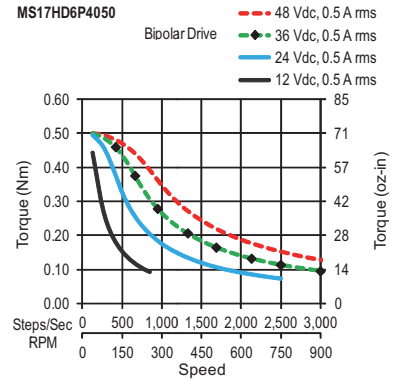

MS17HD
1.8°
Size 17

ML23HS
/ PL23HS
1.8°
Size 23

ML34HD
/ PL34HD
1.8°
Size 34

ML42HS
/ PL42HS
1.8°
Size 42

Technical
& Conversion
Charts

Dynamic Torque Curves

MS17HDB - Bipolar

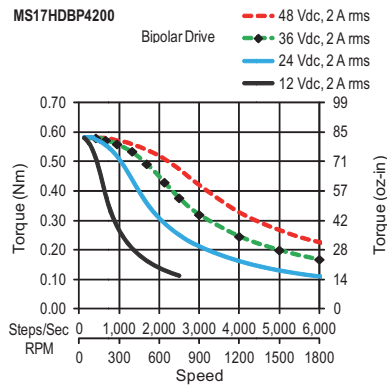
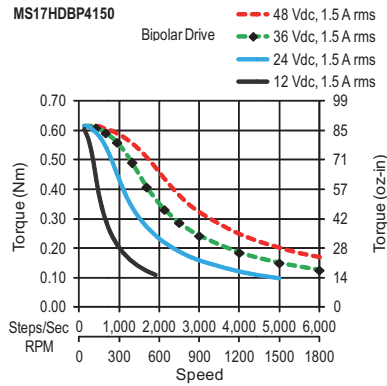
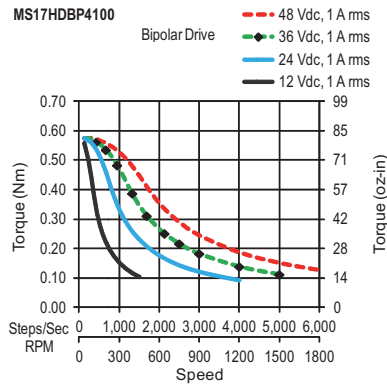

MS17HD4 - Unipolar

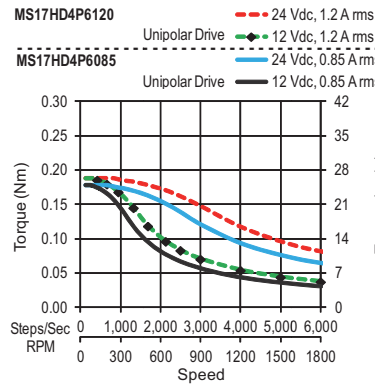
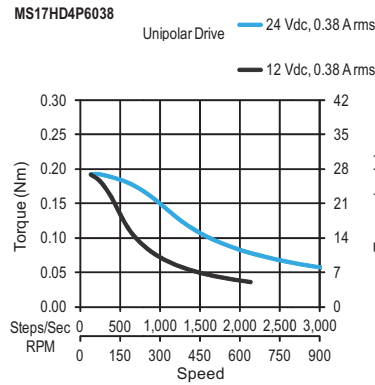

MS17HD6 - Unipolar

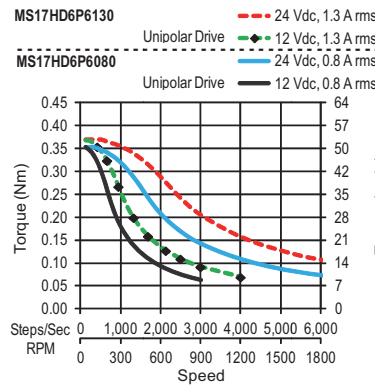

MS17HD2 - Unipolar

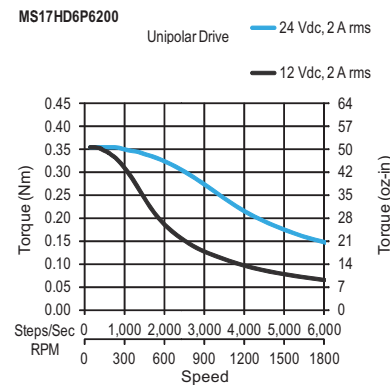
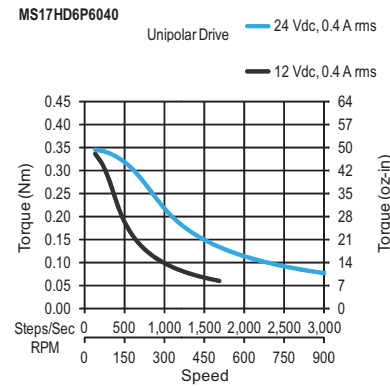
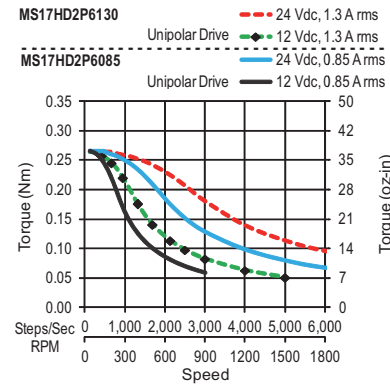
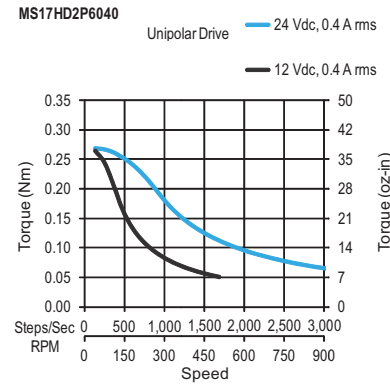

Construction
Model Numbers
Options

MS17HD
1.8°
Size 17

ML23HS
/ PL23HS
1.8°
Size 23

ML34HD
/ PL34HD
1.8°
Size 34

ML42HS
/ PL42HS
1.8°
Size 42

Technical
& Conversion
Charts

ML23HS / PL23HS Series:1.8° - Size 23

- Phases 2
- Steps / Revolution 200
- Step Accuracy ±5%
- Shaft Load (20,000 Hours at 1000 RPM)
 - Axial 40 N (9 Lbs.) Push
 - 130 N (30 Lbs.) Pull
 - Radial 70 N (15.5 Lbs.) At Flat Center
- IP Rating 40
- Approvals RoHS
- Operating Temp. -20°C to +40°C
- Insulation Class B, 130°C
- Insulation Resistance 100 MegOhms



M L23HS 0 P 4 100 -E

Motor Technology		Options	
M	High Torque Step Motor	Omit	No Options
P	PowerPlus Step Motor	-E	0.25 inch diameter rear shaft with encoder mounting holes
Basic Motor Length (Max)		Winding	
0	39 mm (1.54")	###	Current rating x 100
8	55 mm (2.17")	Number of Connections	
A	77 mm (3.03")	4	4 Lead - Bipolar
Electrical Connection		6	6 Lead - Unipolar (or Bipolar)
L	Leads	8	8 Lead - Connect as Needed
P	Plug-In Connector		

■ Dimensions: mm (in)

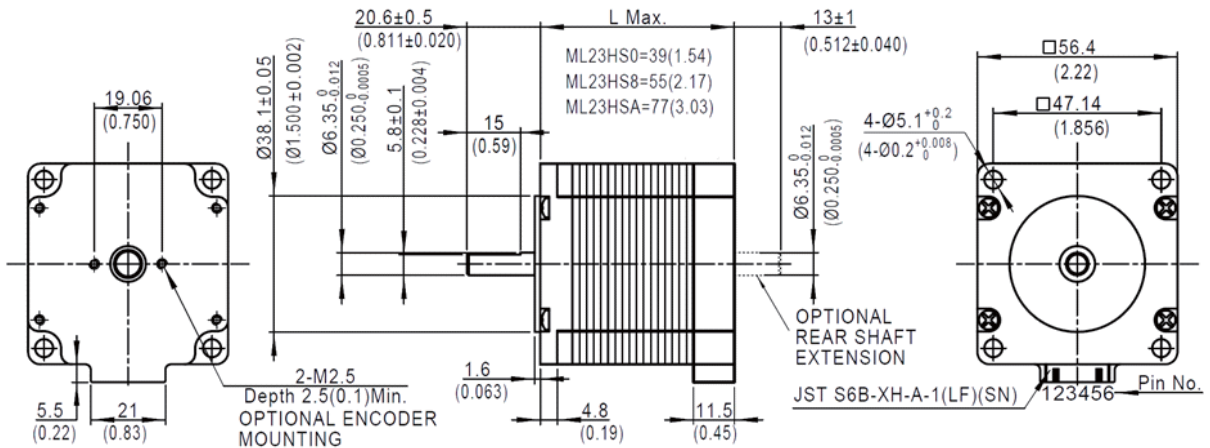

Motors with leads: Lead wire is 22 AWG UL3266, 300 ± 10 (12 ± .5) long

■ ML23HS - 4 Lead Bi-Polar

Length	Model Number	Connect	Mounted			Winding		Detent Torque		Rotor Inertia		Motor Weight	
			Rated Current	Holding Torque		Ohms	mH	Torque		Inertia		Weight	
	Single Shaft	P=Plug L=Leads	Amps	Nm Typ.	oz-in Typ.	±10% @20°C	Typ.	mNm	oz-in	g cm2	oz-in2	kg	Lbs
39 mm (1.54 in.) Short	^ ML23HS0P4100	p	1	0.82	120	6.3	15.9	28	4	120	0.66	0.42	0.93
	^ ML23HS0P4160	p	1.6	0.83	120	2.6	6.5						
	^ ML23HS0P4220	p	2.2	0.84	120	1.39	3.5						
	^ ML23HS0L4350	L	3.5	0.82	120	0.56	1.3						
55 mm (2.17 in.) 1 Stack	^ ML23HS8P4100	p	1	1.50	210	7.6	33	45	6.4	220	1.2	0.6	1.3
	^ ML23HS8P4150	p	1.5	1.50	210	3.1	13.6						
	^ ML23HS8P4220	p	2.2	1.50	210	1.6	6.9						
	^ ML23HS8L4360	L	3.6	1.50	210	0.63	2.6						
	^ ML23HS8L4550	L	5.5	1.50	210	0.28	1.03						
77 mm (3.03 in.) 2 Stack	^ ML23HSAP4100	p	1	2.30	330	8.8	39	75	11	390	2.1	1	2.2
	^ ML23HSAP4150	p	1.5	2.30	330	4.3	18.5						
	^ ML23HSAP4200	p	2	2.30	330	2.3	9.8						
	^ ML23HSAP4300	p	3	2.30	330	1.1	4.5						
	^ ML23HSAL4500	L	5	2.30	330	0.39	1.53						

^ Preferred model

■ PL23HS - PowerPlus - 4 Lead Bi-Polar

Length	Model Number	Connect	Mounted			Winding		Detent Torque		Rotor Inertia		Motor Weight	
			Rated Current	Holding Torque		Ohms	mH	Torque		Inertia		Weight	
	Single Shaft	P=Plug L=Leads	Amps	Nm Typ.	oz-in Typ.	±10% @20°C	Typ.	mNm	oz-in	g cm2	oz-in2	kg	Lbs
55 mm (2.17 in.) 1 Stack	^ PL23HS8P4100	p	1	2.30	330	7.6	26	100	14	220	1.2	0.65	1.4
	^ PL23HS8P4150	p	1.5	2.20	310	3.1	10.7						
	^ PL23HS8P4220	p	2.2	2.30	330	1.6	5.4						
	^ PL23HS8L4360	L	3.6	2.30	330	0.63	2						
	^ PL23HS8L4550	L	5.5	2.20	310	0.28	0.8						
77 mm (3.03 in.) 2 Stack	^ PL23HSAP4100	p	1	3.30	470	8.8	32	150	21	390	2.1	1.1	2.4
	^ PL23HSAP4150	p	1.5	3.40	480	4.3	15.2						
	^ PL23HSAP4200	p	2	3.30	470	2.3	8.1						
	^ PL23HSAP4300	P	3	3.30	470	1.1	3.7						
	^ PL23HSAL4500	L	5	3.30	470	0.39	1.27						

^ Preferred model

■ Mating Connector With Leads (order separately) Dimensions: mm (in)

4 Lead Part Number 4634 1402 01891

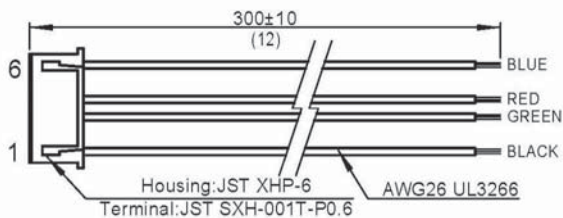

Construction
Model Numbers
Options

MS17HD
1.8°
Size 17

ML23HS
/ PL23HS
1.8°
Size 23

ML34HD
/ PL34HD
1.8°
Size 34

ML42HS
/ PL42HS
1.8°
Size 42

Technical
& Conversion
Charts

Dynamic Torque Curves

ML23HS0 - Bipolar

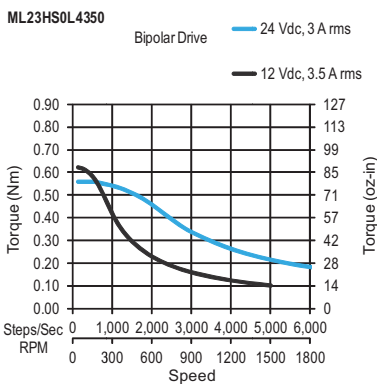
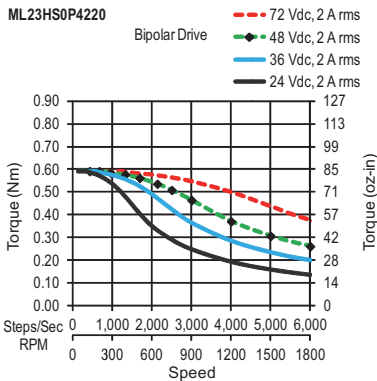
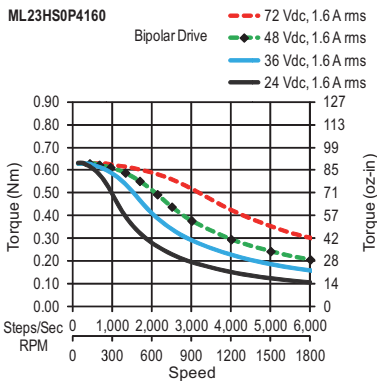
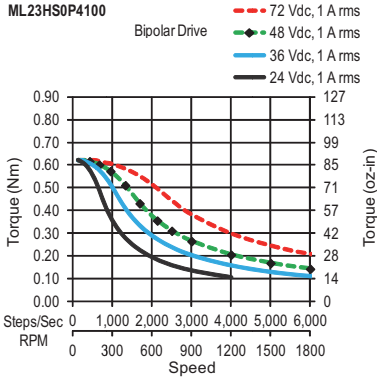

ML23HS8 - Bipolar

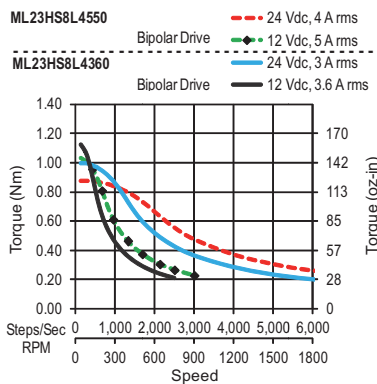
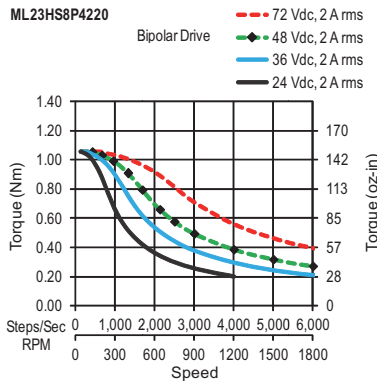
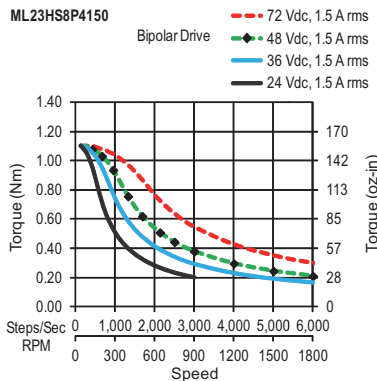
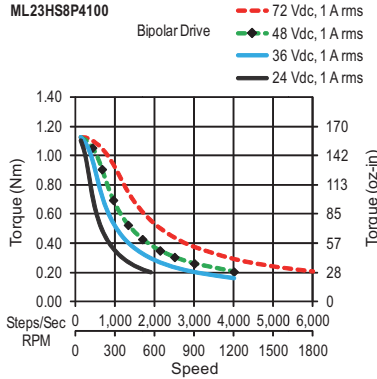

ML23HSA - Bipolar

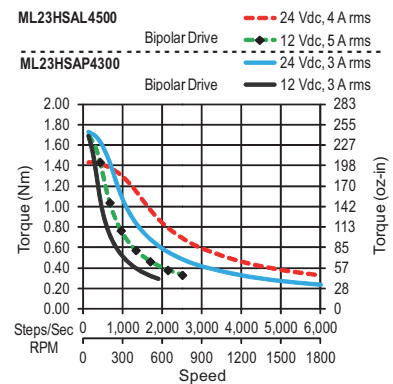
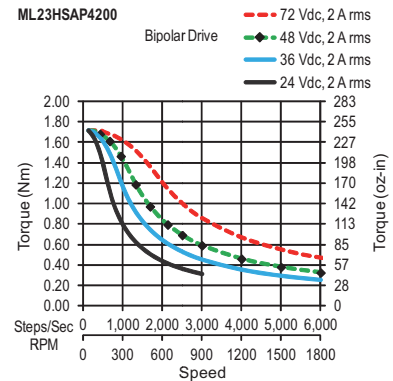
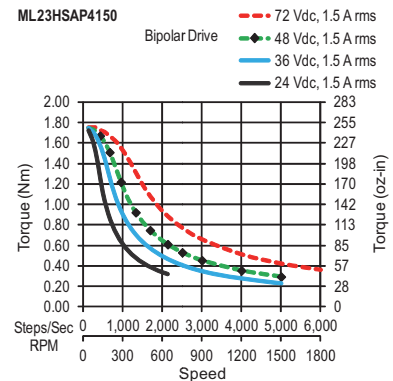
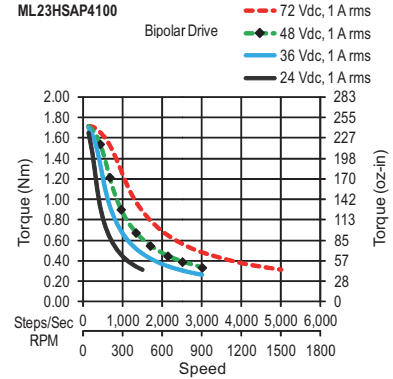

MS17HD
1.8°
Size 17

ML23HS
/ PL23HS
1.8°
Size 23

ML34HD
/ PL34HD
1.8°
Size 34

ML42HS
/ PL42HS
1.8°
Size 42

Technical
& Conversion
Charts

Dynamic Torque Curves

PowerPlus PL23HS8 - Bipolar

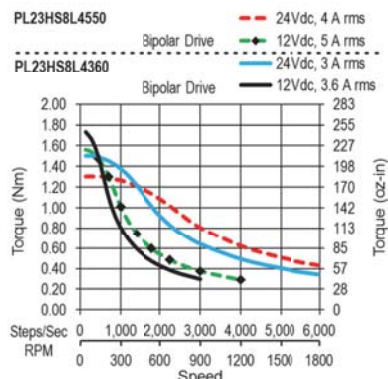
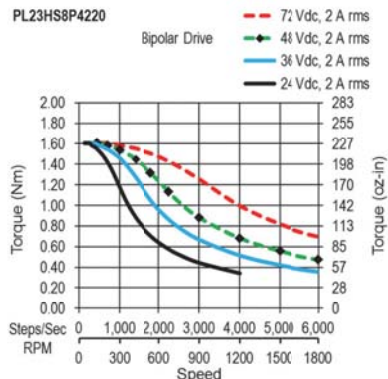
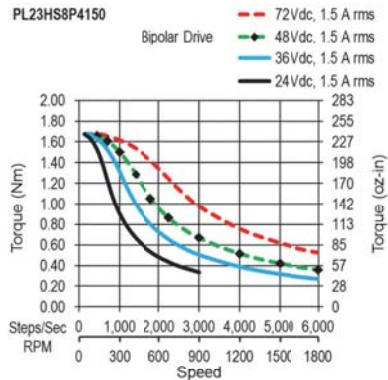
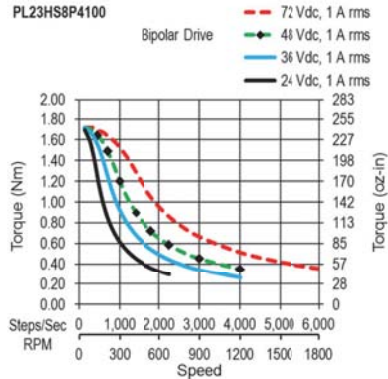

PowerPlus PL23HSA - Bipolar

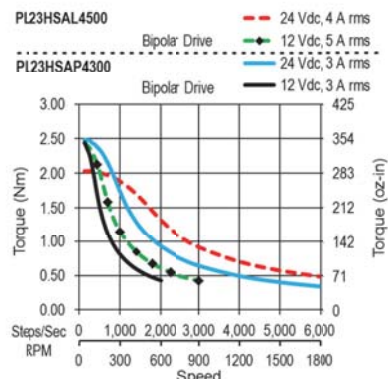
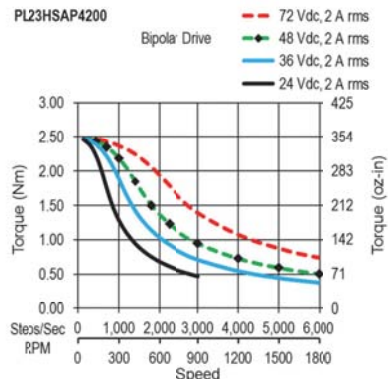
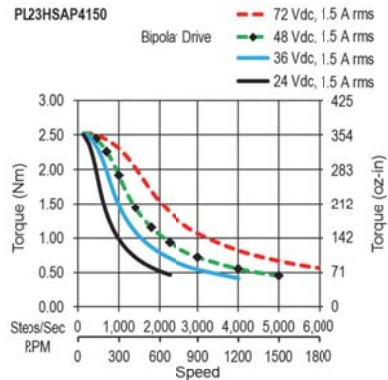
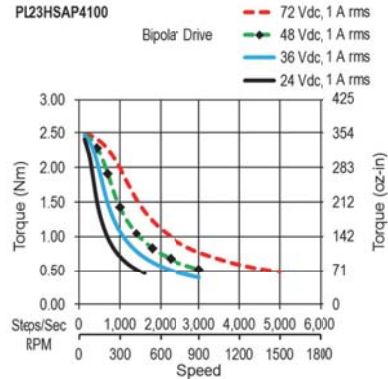

Construction
Model Numbers
Options

MS17HD
1.8°
Size 17

ML23HS
/ PL23HS
1.8°
Size 23

ML34HD
/ PL34HD
1.8°
Size 34

ML42HS
/ PL42HS
1.8°
Size 42

Technical
& Conversion
Charts

ML34HD / PL34HD Series: 1.8° - Size 34

- Phases 2
- Steps / Revolution 200
- Step Accuracy ±5%
- Shaft Load (20,000 Hours at 1000 RPM)
 - Axial 65 N (15 Lbs.) Push
 - 155 N (35 Lbs.) Pull
 - Radial 220 N (50 Lbs.) At Flat Center
- IP Rating 40
- Approvals RoHS
- Operating Temp. -20°C to +40°C
- Insulation Class B, 130°C
- Insulation Resistance 100 MegOhms



Construction
Model Numbers
Options

MS17HD
1.8°
Size 17

ML23HS
/ PL23HS
1.8°
Size 23

ML34HD
/ PL34HD
1.8°
Size 34

ML42HS
/ PL42HS
1.8°
Size 42

Technical
& Conversion
Charts

M L34HD 0 L 8 350 -E

Motor Technology

- M** High Torque Step Motor
- P** PowerPlus Step Motor

Basic Motor Length (Max)

0	67 mm (2.64")	1 Stack
1	97 mm (3.82")	2 Stack
2	126 mm (4.96")	3 Stack

Electrical Connection

L Leads

Option

- Omit No Options
- E** 0.375 inch diameter rear shaft with encoder mounting holes

Winding

- ###** Current rating x 100
- X##** for 11 to 19 amps:
X10= 11 amps, X40 = 14 amps

Number of Connections

- 4** 4 Lead - Bipolar
- 8** 8 Lead - Connect as Needed

■ Dimensions: mm (in)

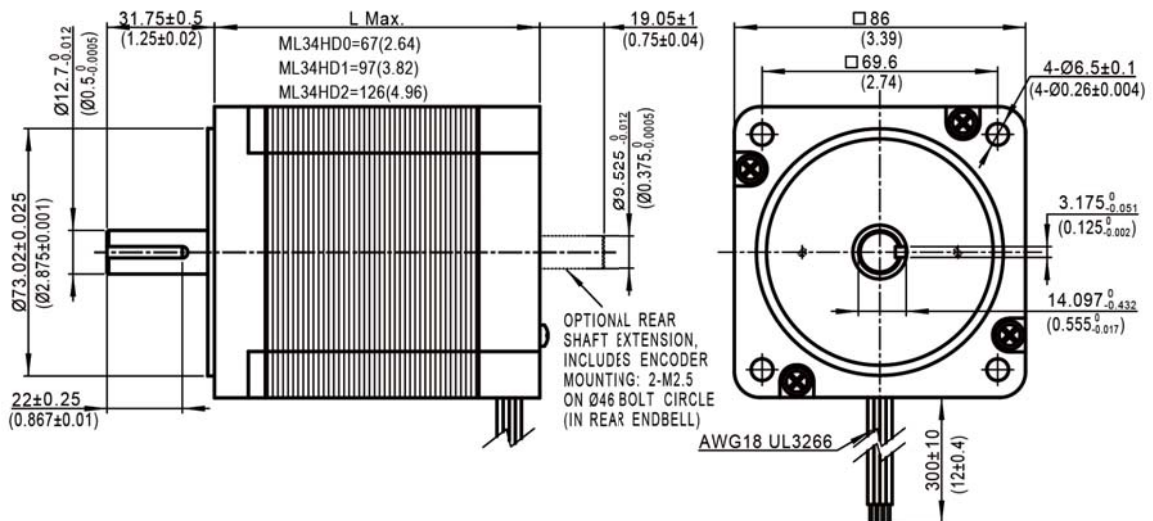
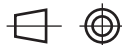

■ ML34HD - 4 Lead & 8 Lead

Length	Model Number	Connect	Mounted			Winding		Detent Torque		Rotor Inertia		Motor Weight		
			Rated Current	Holding Torque		Ohms	mH	mNm	oz-in	g cm2	oz-in2	kg	Lbs	
			Amps	Nm Typ.	oz-in Typ.	±10% @20°C	Typ.							
4 Lead	67 mm (2.64 in.) 1 Stack	^ ML34HD0L4160	L	1.6	3.7	520	3.9	42	90	13	950	5.2	1.6	3.5
		ML34HD0L4350	L	3.5	3.8	540	0.95	9.5						
		ML34HD0L4500	L	5	3.8	540	0.48	4.5						
		ML34HD0L4700	L	7	3.8	540	0.26	2.4						
		ML34HD0L4X00	L	10	3.8	540	0.138	1.13						
	97 mm (3.82 in.) 2 Stack	^ ML34HD1L4200	L	2	7.2	1000	3.6	50	150	21	1600	8.8	2.7	6
		ML34HD1L4350	L	3.5	7.2	1000	1.34	15.9						
		ML34HD1L4500	L	5	7.2	1000	0.61	8						
		ML34HD1L4700	L	7	7.2	1000	0.36	4						
		ML34HD1L4X00	L	10	7.2	1000	0.188	2						
	126 mm (4.96 in.) 3 Stack	^ ML34HD2L4200	L	2	10.0	1400	4.1	63	200	28	2350	13	3.8	8.4
		ML34HD2L4350	L	3.5	10.0	1400	1.44	20						
ML34HD2L4500		L	5	10.0	1400	0.72	9.4							
ML34HD2L4700		L	7	10.0	1400	0.38	5							
ML34HD2L4X00		L	10	10.0	1400	0.22	2.3							
8 Lead	67 mm (2.64 in.) 1 Stack	^ ML34HD0L8350	L-Series	3.5	3.8	540	0.98	9.5	90	13	950	5.2	1.6	3.5
			L-Parallel	7	3.8	540	0.25	2.4						
		^ ML34HD0L8500	L-Series	5	3.8	540	0.5	4.5						
			L-Parallel	10	3.8	540	0.126	1.13						
	97 mm (3.82 in.) 2 Stack	^ ML34HD1L8350	L-Series	3.5	7.2	1000	1.37	15.9	150	21	1600	8.8	2.7	6
			L-Parallel	7	7.2	1000	0.34	4						
		^ ML34HD1L8500	L-Series	5	7.2	1000	0.71	8						
			L-Parallel	10	7.2	1000	0.177	2						
	126 mm (4.96 in.) 3 Stack	^ ML34HD2L8350	L-Series	3.5	10.0	1400	1.48	20	200	28	2350	13	3.8	8.4
			L-Parallel	7	10.0	1400	0.37	5						
		^ ML34HD2L8500	L-Series	5	10.0	1400	0.82	9.4						
			L-Parallel	10	10.0	1400	0.21	2.3						

^ Preferred model

■ PL34HD - PowerPlus - 4 Lead & 8 Lead

Length	Model Number	Connect	Mounted			Winding		Detent Torque		Rotor Inertia		Motor Weight		
			Rated Current	Holding Torque		Ohms	mH	mNm	oz-in	g cm2	oz-in2	kg	Lbs	
			Amps	Nm Typ.	oz-in Typ.	±10% @20°C	Typ.							
4 Lead	67 mm (2.64 in.) 1 Stack	^ PL34HD0L4160	L	1.6	4.7	670	3.9	33	135	19	950	5.2	1.6	3.5
		PL34HD0L4350	L	3.5	4.8	670	0.95	7.6						
		PL34HD0L4500	L	5	4.8	670	0.48	3.6						
		PL34HD0L4700	L	7	4.8	670	0.26	1.89						
		PL34HD0L4X00	L	10	4.8	670	0.138	0.91						
	97 mm (3.82 in.) 2 Stack	^ PL34HD1L4200	L	2	9.0	1300	3.6	40	225	32	1600	8.8	2.7	6
		PL34HD1L4350	L	3.5	9.0	1300	1.34	12.8						
		PL34HD1L4500	L	5	9.0	1300	0.61	6.4						
		PL34HD1L4700	L	7	9.0	1300	0.36	3.2						
		PL34HD1L4X00	L	10	9.0	1300	0.188	1.6						
	126 mm (4.96 in.) 3 Stack	^ PL34HD2L4200	L	2	12.7	1800	4.1	51	300	42	2350	13	3.8	8.4
		PL34HD2L4350	L	3.5	12.3	1700	1.44	16.1						
PL34HD2L4500		L	5	12.3	1700	0.72	7.5							
PL34HD2L4700		L	7	12.3	1700	0.38	4							
PL34HD2L4X00		L	10	12.3	1700	0.22	1.87							
8 Lead	67 mm (2.64 in.) 1 Stack	^ PL34HD0L8350	L-Series	3.5	4.8	670	0.98	7.6	135	19	950	5.2	1.6	3.5
			L-Parallel	7	4.8	670	0.25	1.89						
		^ PL34HD0L8500	L-Series	5	4.8	670	0.5	3.6						
			L-Parallel	10	4.8	670	0.126	0.91						
	97 mm (3.82 in.) 2 Stack	^ PL34HD1L8350	L-Series	3.5	9.0	1300	1.37	12.8	225	32	1600	8.8	2.7	6
			L-Parallel	7	9.0	1300	0.34	3.2						
		^ PL34HD1L8500	L-Series	5	9.0	1300	0.71	6.4						
			L-Parallel	10	9.0	1300	0.177	1.6						
	126 mm (4.96 in.) 3 Stack	^ PL34HD2L8350	L-Series	3.5	12.3	1700	1.48	16.1	300	42	2350	13	3.8	8.4
			L-Parallel	7	12.3	1700	0.37	4						
		^ PL34HD2L8500	L-Series	5	12.3	1700	0.82	7.5						
			L-Parallel	10	12.3	1700	0.21	1.87						

^ Preferred model

Construction
Model Numbers
Options

MS17HD
1.8"
Size 17

ML23HS
/ PL23HS
1.8"
Size 23

ML34HD
/ PL34HD
1.8"
Size 34

ML42HS
/ PL42HS
1.8"
Size 42

Technical
& Conversion
Charts

Dynamic Torque Curves

Construction
Model Numbers
Options

MS17HD
1.8°
Size 17

ML23HS
/ PL23HS
1.8°
Size 23

ML34HD
/ PL34HD
1.8°
Size 34

ML42HS
/ PL42HS
1.8°
Size 42

Technical
& Conversion
Charts

ML34HD0

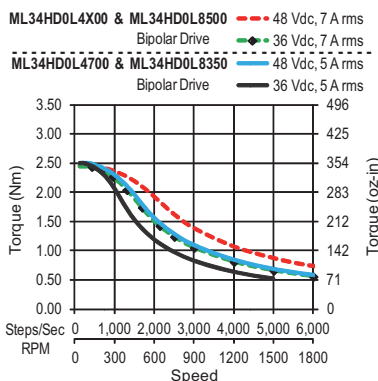
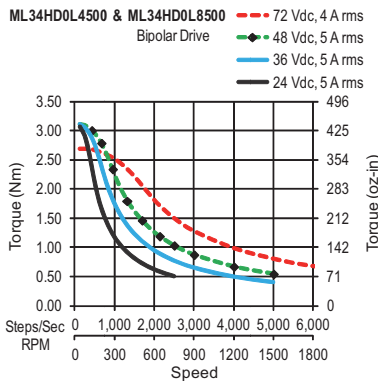
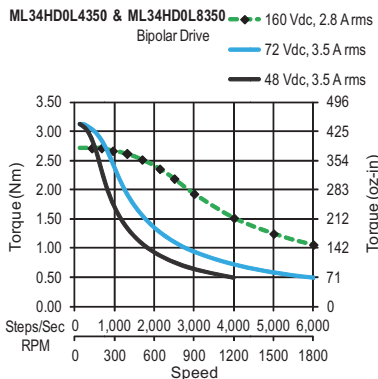
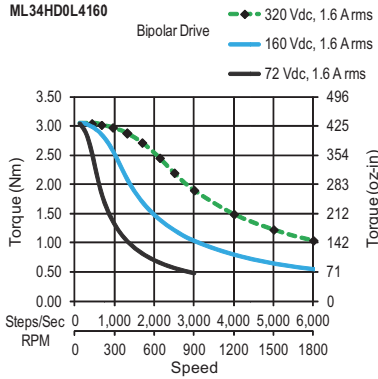

ML34HD1

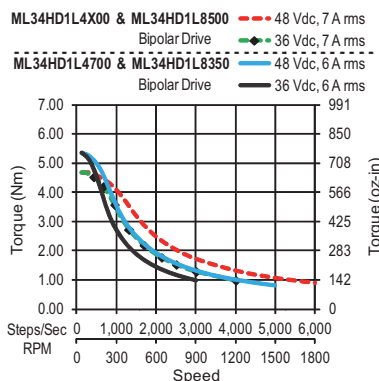
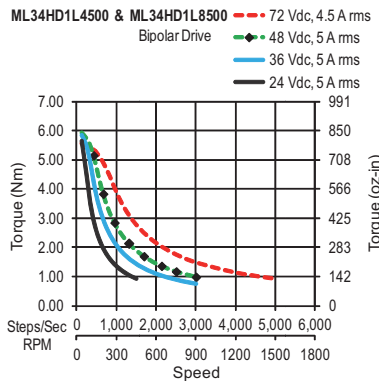
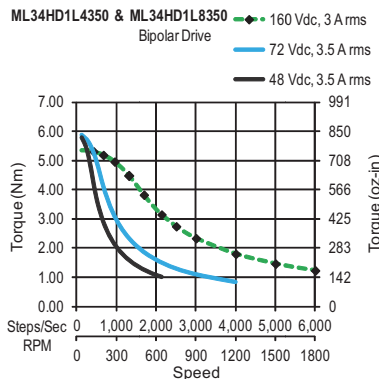
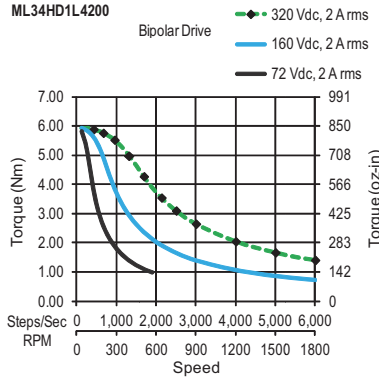

ML34HD2

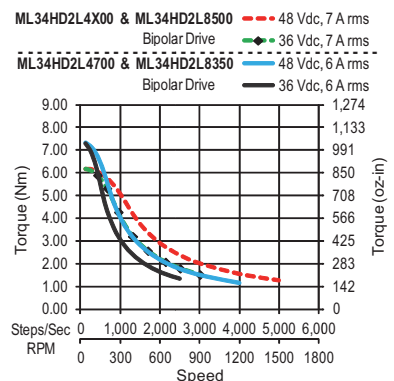
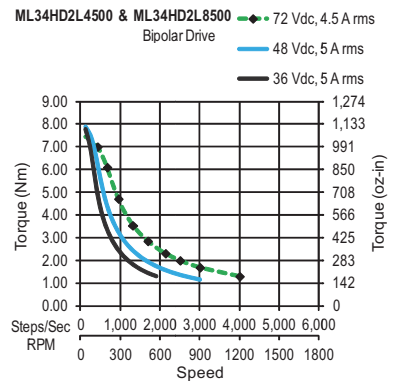
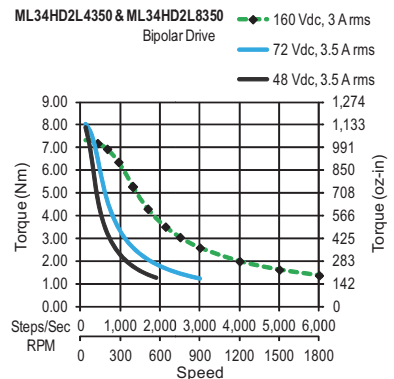
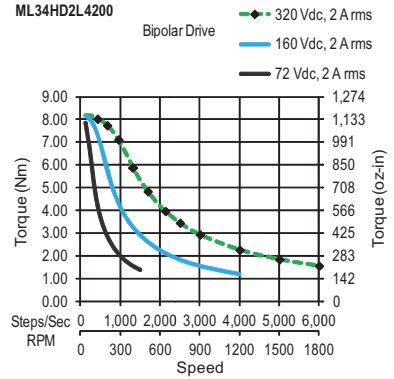

Dynamic Torque Curves

PowerPlus PL34HD0

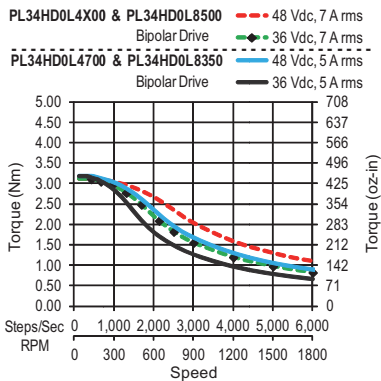
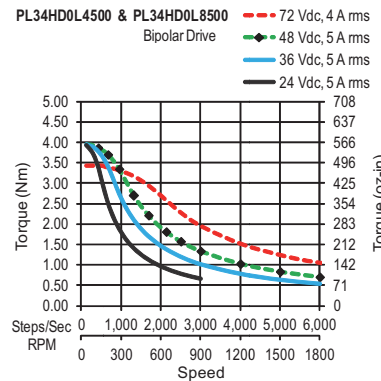
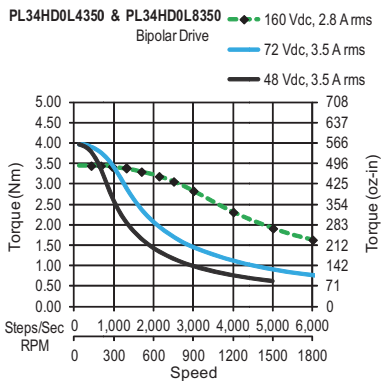
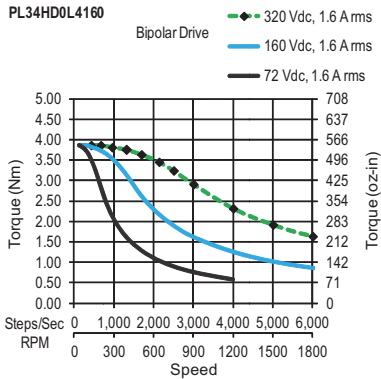

PowerPlus PL34HD1

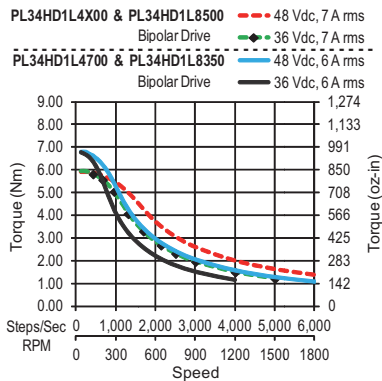
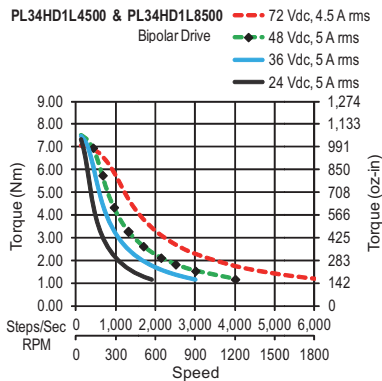
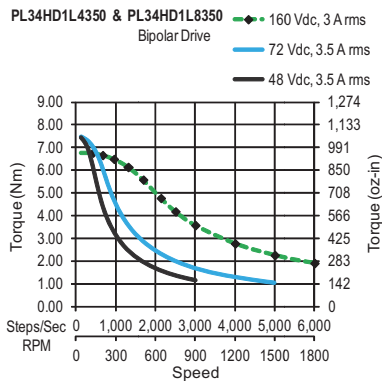
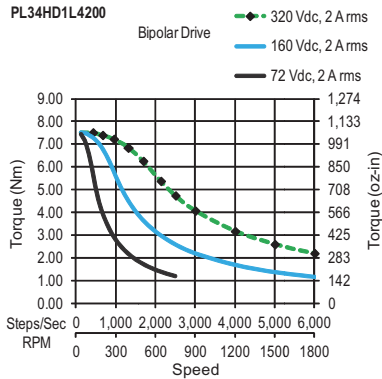

PowerPlus PL34HD2

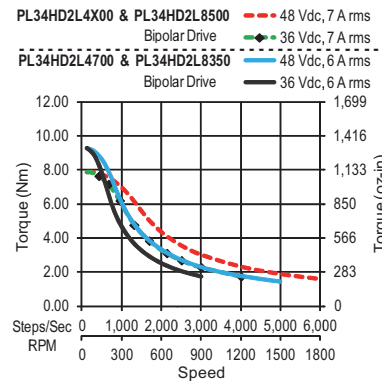
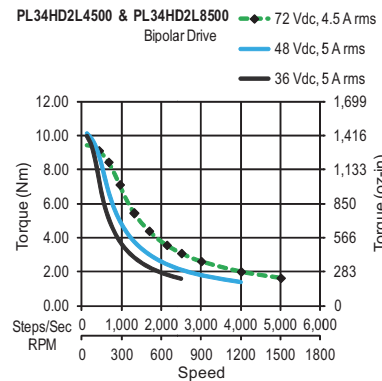
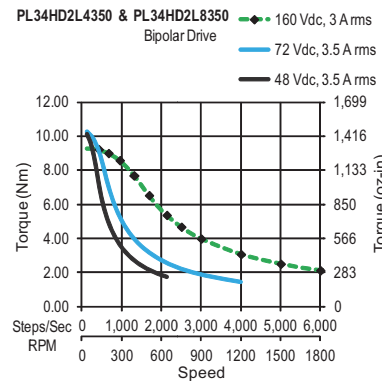
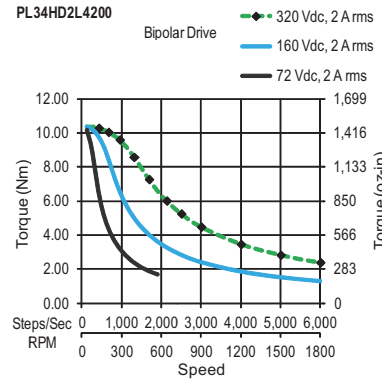

Construction Model Numbers Options

MS17HD 1.8" Size 17

ML23HS / PL23HS 1.8" Size 23

ML34HD / PL34HD 1.8" Size 34

ML42HS / PL42HS 1.8" Size 42

Technical & Conversion Charts

ML42HS / PL42HS Series:1.8° - Size 42

- Phases 2
- Steps / Revolution 200
- Step Accuracy ±5%
- Shaft Load (20,000 Hours at 1000 RPM)
 - Axial 550 N (125 Lbs.) Push & Pull
 - Radial 450 N (100 Lbs.) At Keyway Center
- IP Rating 40
- Approvals RoHS
- Operating Temp. -20°C to +40°C
- Insulation Class B, 130°C
- Insulation Resistance 100 MegOhms



Construction / Model Numbers Options

MS17HD 1.8° Size 17

ML23HS / PL23HS 1.8° Size 23

ML34HD / PL34HD 1.8° Size 34

ML42HS / PL42HS 1.8° Size 42

Technical & Conversion Charts

M L42HS 0 L 8 350

Motor Technology

- M** High Torque Step Motor
- P** PowerPlus Step Motor

Basic Motor Length (Max)

- 0** 100 mm (3.94")
- 2** 151 mm (5.95")
- 3** 202 mm (7.95")

Electrical Connection

L Leads

Winding

Current rating x 100
X## for 11 to 19 amps:
 X10= 11 amps, X40 = 14 amps

Number of Connections

- 4** 4 Lead - Bipolar
- 8** 8 Lead - Connect as Needed

■ Dimensions: mm (in)

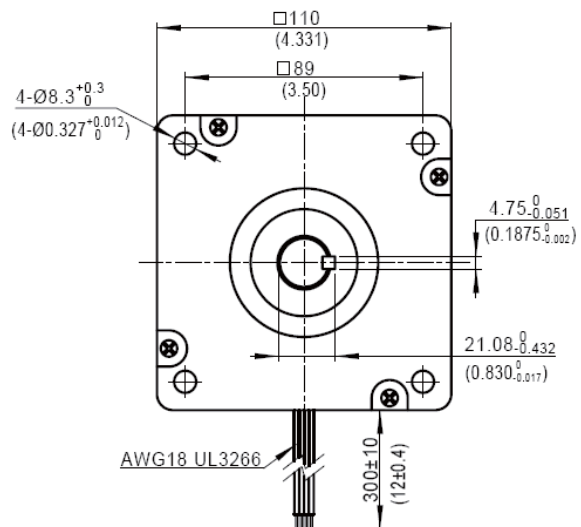
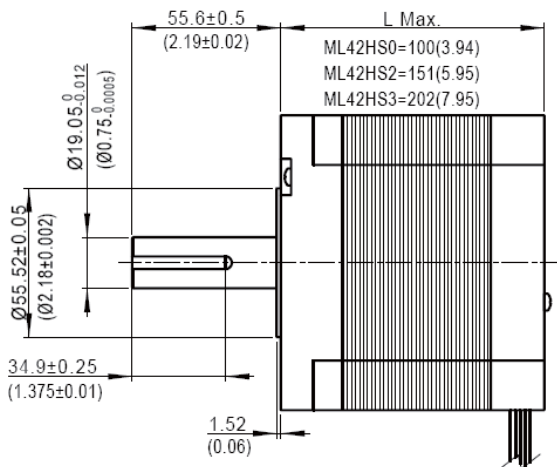
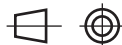

ML42HD - 4 Lead & 8 Lead

Length	Model Number	Connect	Mounted			Winding		Detent Torque		Rotor Inertia		Motor Weight		
			Rated Current	Holding Torque		Ohms ±10% @20°C	mH Typ.	mNm	oz-in	g cm2	oz-in2	kg	Lbs	
				Amps	Nm Typ.									oz-in Typ.
4 Lead	100 mm (3.94 in.) 1 Stack	L	2.1	12	1700	4.1	78	300	42	5500	30	5	11	
			4.2	12	1700	1.16	19.8							
			6	12	1700	0.61	10.1							
			8.4	12	1700	0.31	5							
			12	12	1700	0.167	2.5							
	151 mm (5.94 in.) 2 Stack	L	2.4	22	3100	4.2	90	600	85	10900	60	8.3	18	
			6	22	3100	0.75	14.5							
			8	22	3100	0.41	8.5							
			12	22	3100	0.177	3.6							
			16	22	3100	0.116	2.1							
	202 mm (7.95 in.) 3 Stack	L	2.7	31	4400	4.2	100	800	110	16200	89	11.6	26	
			6	31	4400	1.02	22							
8			32	4500	0.55	13								
12			31	4400	0.24	5.5								
16			32	4500	0.152	3.2								
8 Lead	100 mm (3.94 in.) 1 Stack	L-Series	4.2	12	1700	1.19	19.8	300	42	5500	30	5	11	
		L-Parallel	8.4	12	1700	0.3	5							
		L-Series	6	12	1700	0.64	10.1							
		L-Parallel	12	12	1700	0.159	2.5							
		L-Series	6	22	3100	0.68	14.5							
		L-Parallel	12	22	3100	0.17	3.6							
	151 mm (5.94 in.) 2 Stack	L	L-Series	8	22	3100	0.43	8.5	600	85	10900	60	8.3	18
			L-Parallel	16	22	3100	0.108	2.1						
			L-Series	6	31	4400	0.91	22						
			L-Parallel	12	31	4400	0.23	5.5						
			L-Series	8	32	4500	0.58	13						
			L-Parallel	16	32	4500	0.144	3.2						

^ Preferred model

PL42HS - PowerPlus - 4 Lead & 8 Lead

Length	Model Number	Connect	Mounted			Winding		Detent Torque		Rotor Inertia		Motor Weight		
			Rated Current	Holding Torque		Ohms ±10% @20°C	mH Typ.	mNm	oz-in	g cm2	oz-in2	kg	Lbs	
				Amps	Nm Typ.									oz-in Typ.
4 Lead	100 mm (3.94 in.) 1 Stack	L	2.1	16	2300	4.1	60	450	64	5500	30	5	11	
			4.2	16	2300	1.16	15.4							
			6	16	2300	0.61	7.8							
			8.4	16	2300	0.31	3.8							
			12	16	2300	0.167	1.96							
	151 mm (5.94 in.) 2 Stack	L	2.4	28	4000	4.2	69	900	130	10900	60	8.3	18	
			6	28	4000	0.75	11.1							
			8	29	4100	0.41	6.5							
			12	28	4000	0.177	2.8							
			16	29	4100	0.116	1.62							
	202 mm (7.95 in.) 3 Stack	L	2.7	40	5700	4.2	77	1200	170	16200	89	11.6	26	
			6	41	5800	1.02	17.1							
8			42	5900	0.55	10								
12			41	5800	0.24	4.3								
16			42	5900	0.152	2.5								
8 Lead	100 mm (3.94 in.) 1 Stack	L-Series	4.2	16	2300	1.19	15.4	450	64	5500	30	5	11	
		L-Parallel	8.4	16	2300	0.3	3.8							
		L-Series	6	16	2300	0.64	7.8							
		L-Parallel	12	16	2300	0.159	1.96							
		L-Series	6	28	4000	0.68	11.1							
		L-Parallel	12	28	4000	0.17	2.8							
	151 mm (5.94 in.) 2 Stack	L	L-Series	8	29	4100	0.43	6.5	900	130	10900	60	8.3	18
			L-Parallel	16	29	4100	0.108	1.62						
			L-Series	6	41	5800	0.91	17.1						
			L-Parallel	12	41	5800	0.23	4.3						
			L-Series	8	42	5900	0.58	10						
			L-Parallel	16	42	5900	0.144	2.5						

^ Preferred model

Construction
Model Numbers
Options

MS17HD
1.8"
Size 17

ML23HS
/ PL23HS
1.8"
Size 23

ML34HD
/ PL34HD
1.8"
Size 34

ML42HS
/ PL42HS
1.8"
Size 42

Technical
& Conversion
Charts

Dynamic Torque Curves

Construction
Model Numbers
Options

MS17HD
1.8°
Size 17

ML23HS
/ PL23HS
1.8°
Size 23

ML34HD
/ PL34HD
1.8°
Size 34

ML42HS
/ PL42HS
1.8°
Size 42

Technical
& Conversion
Charts

ML42HS0

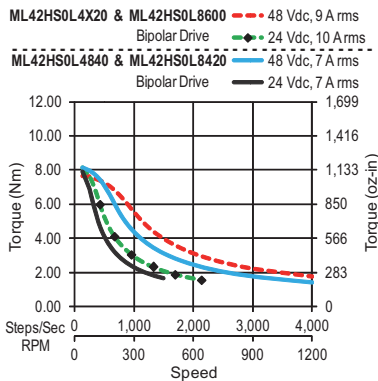
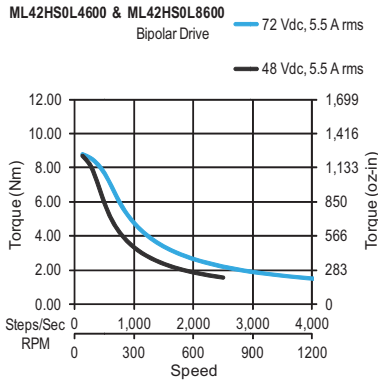
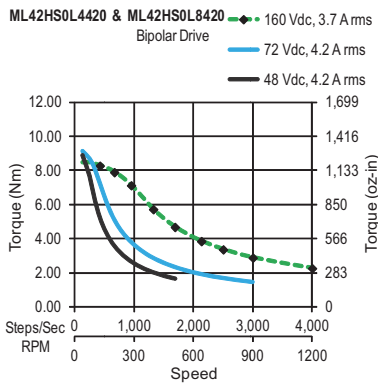
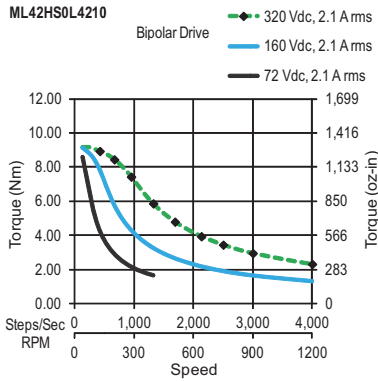

ML42HS2

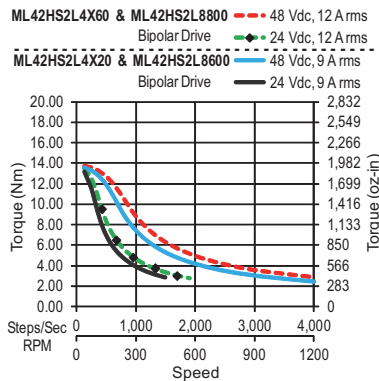
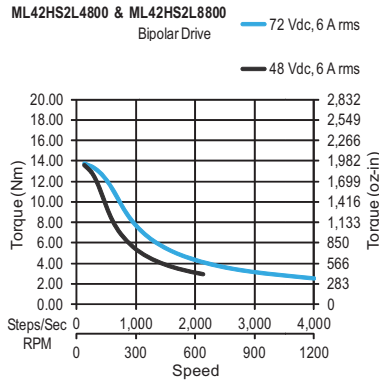
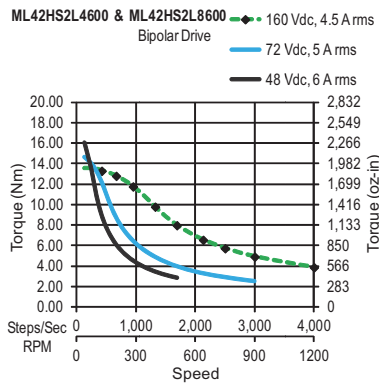
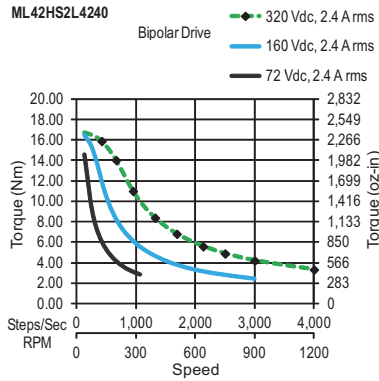

ML42HS3

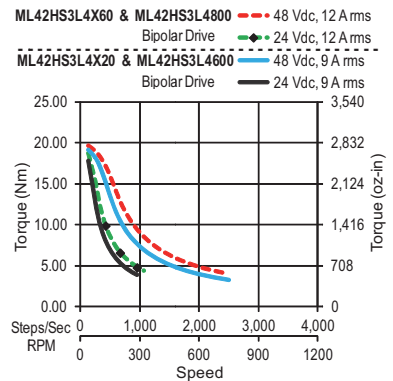
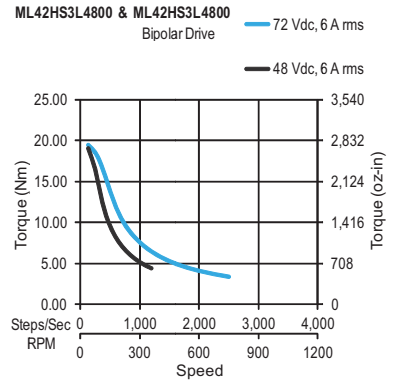
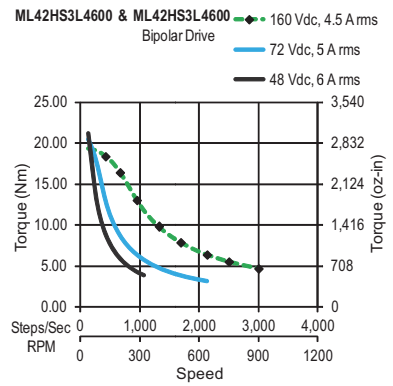
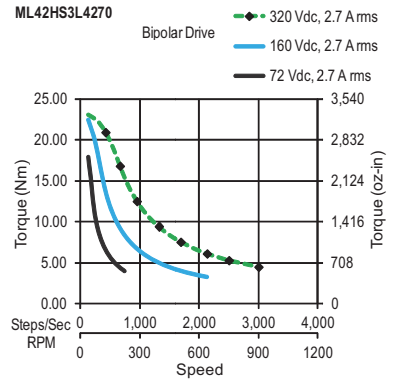

Dynamic Torque Curves

PowerPlus PL42HS0

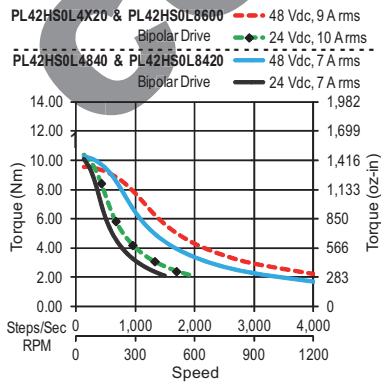
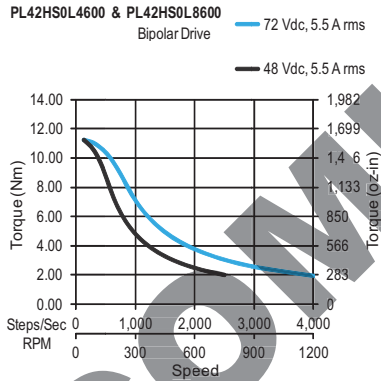
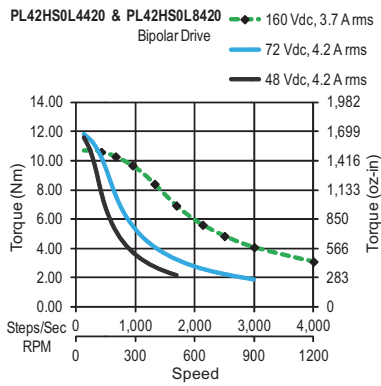
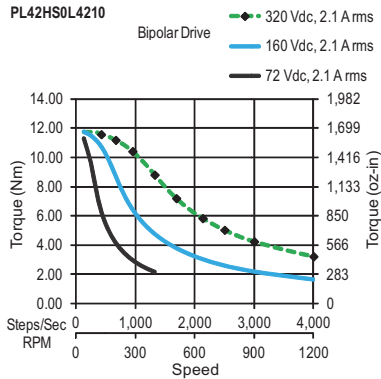

PowerPlus PL42HS2

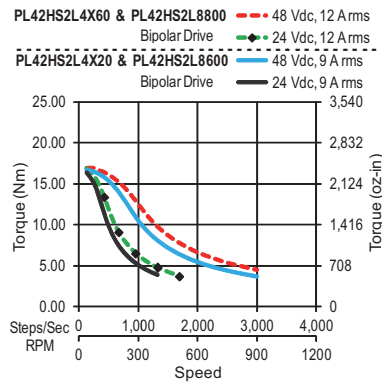
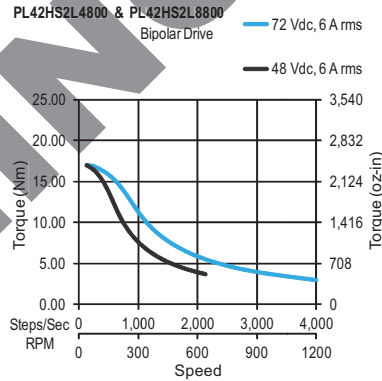
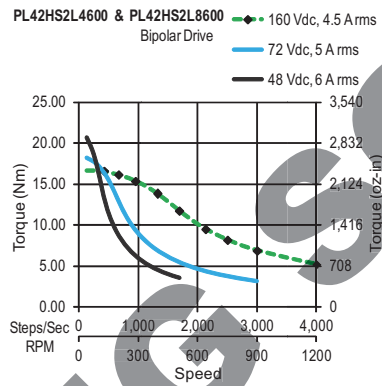
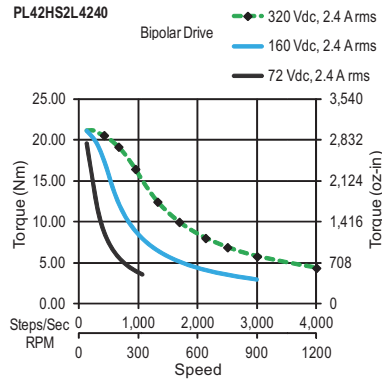

PowerPlus PL42HS3

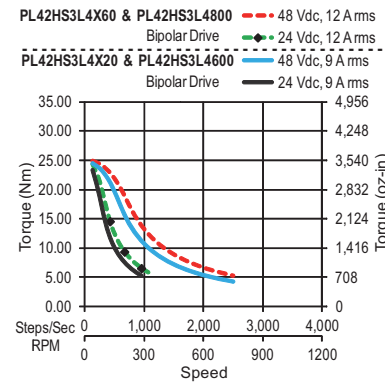
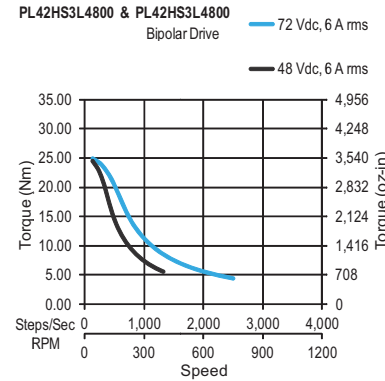
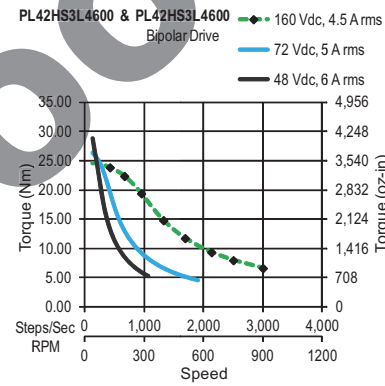
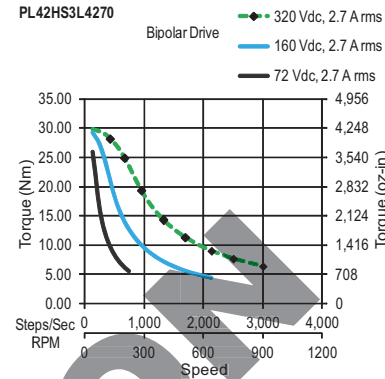

Construction
Model Numbers
Options

MS17HD
1.8"
Size 17

ML23HS
/ PL23HS
1.8"
Size 23

ML34HD
/ PL34HD
1.8"
Size 34

ML42HS
/ PL42HS
1.8"
Size 42

Technical
& Conversion
Charts

Technical Information

Step Sequence

Bipolar, Full step

STEP	Phase 1		Phase 2		
	A	C	B	D	
1	+	-	+	-	
2	-	+	+	-	
3	-	+	-	+	
4	+	-	-	+	

CW(clockwise) & CCW(counter clockwise) rotation when seen from the flange side of the motor

Unipolar, Full step

STEP	Phase 1			Phase 2			
	A	O	C	B	M	D	
1	-	+		-	+		
2		+	-	-	+		
3		+	-		+	-	
4	-	+			+	-	

CW(clockwise) & CCW(counter clockwise) rotation when seen from the flange side of the motor

Schematic Diagrams

----- 4 Lead (Bipolar) -----

Lead Connector
Color Pin #

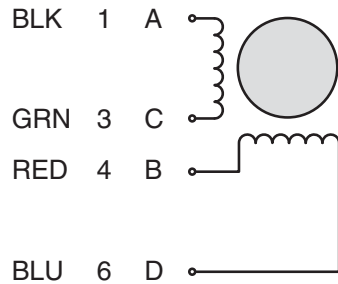

----- 6 Lead (Unipolar) -----

Lead Connector
Color Pin #

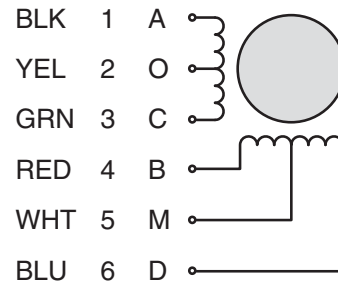

----- 8 Lead -----

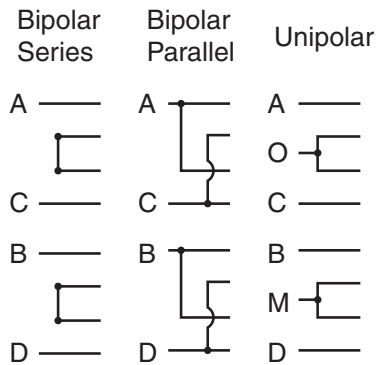

Lead Connector
Color Pin #

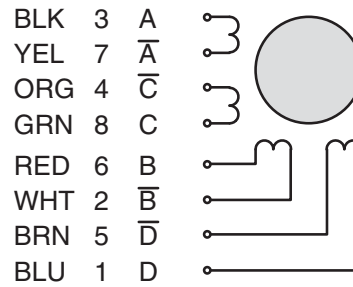

Construction
Model Numbers
Options

MS17HD
1.8°
Size 17

ML23HS
/ PL23HS
1.8°
Size 23

ML34HD
/ PL34HD
1.8°
Size 34

ML42HS
/ PL42HS
1.8°
Size 42

Technical
& Conversion
Charts

Conversion Factors

Length

A \ B	mm	cm	m	inch	feet
mm	=====	0.1	0.001	0.03937	0.003281
cm	10	=====	0.01	0.3937	0.03281
m	1000	100	=====	39.37	3.281
inch	25.4	2.54	0.0254	=====	0.08333
feet	304.8	30.48	0.3048	12	=====

Multiply "A" units
by conversion factor
to obtain "B" units

Force

A \ B	g	kgf	oz	lb	Newton
g	=====	0.001	0.03527	0.002205	0.0098
kgf	1000	=====	35.27	2.205	9.807
oz	28.35	0.02835	=====	0.0625	0.278
lb	453.6	0.4536	16	=====	4.448
Newton	102	0.102	3.597	0.2248	=====

Torque

	Nm	Ncm	mNm	kgm*	kgcm*	gcm*	oz-in	lb-ft	lb-in
Nm	=====	100	1000	0.102	10.2	10200	141.6	0.7376	8.851
Ncm	0.01	=====	10	0.00102	0.102	102	1.416	0.007376	0.08851
mNm	0.001	0.1	=====	0.000102	0.0102	10.2	0.1416	0.000738	0.008851
kgm*	9.807	980.7	9807	=====	100	100000	1389	7.233	86.8
kgcm*	0.09807	9.807	98.07	0.01	=====	1000	13.89	0.07233	0.868
gcm*	9.81E-05	0.009807	0.09807	0.00001	0.001	=====	0.01389	7.23E-05	0.000868
oz-in	0.007062	0.7062	7.062	0.00072	0.07201	72.01	=====	0.00521	0.0625
lb-ft	1.356	135.6	1356	0.1383	13.83	13830	192	=====	12
lb-in	0.113	11.3	113	0.01152	1.152	1152	16	0.0833	=====

Inertia

	kgm ²	kgcm ²	gcm ²	oz-in ²	oz-in-sec ²	lb-in ²	lb-in-sec ²	lb-ft ²	lb-ft-sec ² (slug ft ²)
kgm ²	=====	10000	10000000	54700	142	3420	8.85	23.7	0.738
kgcm ²	0.00001	=====	1000	5.47	0.0142	0.342	0.000885	0.00237	7.38E-05
gcm ²	1E-07	0.001	=====	0.00547	1.42E-05	0.000342	8.85E-07	2.37E-06	7.38E-08
oz-in ²	1.83E-05	0.1829	183	=====	0.00259	0.0625	0.000162	0.000434	1.35E-05
oz-in-sec ²	0.00706	70.62	70600	386	=====	24.1	0.0625	0.168	0.00521
lb-in ²	0.000293	2.926	2930	16	0.0414	=====	0.00259	0.00694	0.000216
lb-in-sec ²	0.113	1130	1130000	6180	1.6	386	=====	2.68	0.0833
lb-ft ²	0.0421	421.4	421000	2300	5.97	144	0.373	=====	0.0318
lb-ft-sec ² (slug ft ²)	1.36	13600	13600000	74100	192	4630	12	32.2	=====

Construction
Model Numbers
Options

MS17HD
1.8"
Size 17

ML23HS
/ PL23HS
1.8"
Size 23

ML34HD
/ PL34HD
1.8"
Size 34

ML42HS
/ PL42HS
1.8"
Size 42

Technical
& Conversion
Charts

Construction
Model Numbers
Options

MS17HD
1.8°
Size 17

ML23HS
/ PL23HS
1.8°
Size 23

ML34HD
/ PL34HD
1.8°
Size 34

ML42HS
/ PL42HS
1.8°
Size 42

Technical
& Conversion
Charts

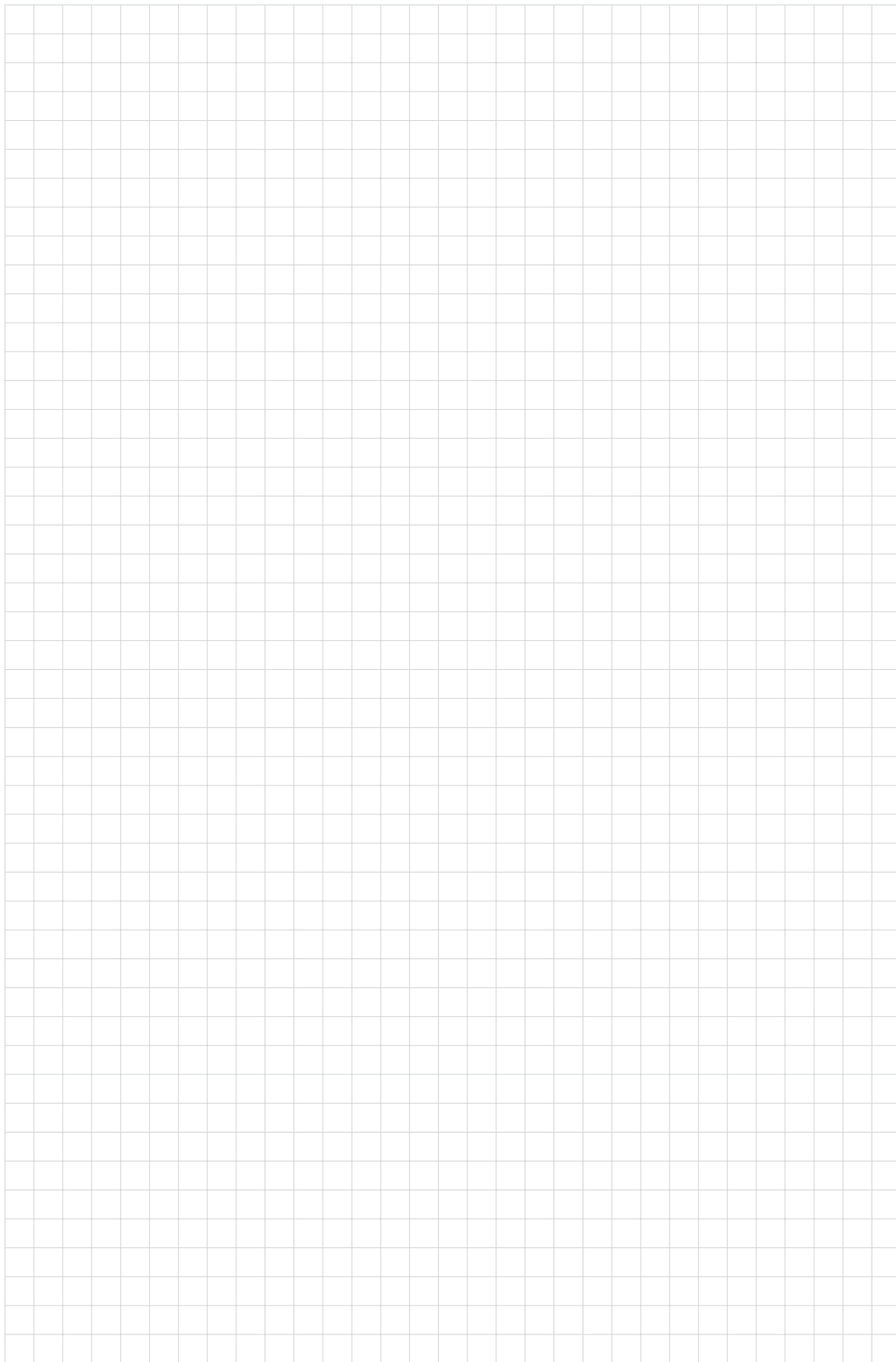

MOONS' Industries was founded in 1994 and has grown to become one of the largest manufactures of step motors in the world. MOONS' growth has been driven by our founding principles of "world class" quality, outstanding value, and customer support.

In addition to hybrid step motors, MOONS' also designs and manufactures:

- **PM Step Motors**
- **Servo Motors**
- **Brushless DC Motors**
- **Motor Drives**
- **Wire Harnesses**
- **Industrial Controls**

MOONS' Headquarters:

168 Mingjia Road, Minhang District
Shanghai 201107, P.R.China
Tel: +86 (0)21 52634688
Fax: +86 (0)21 52634098

Europe Branch:

MOONS' Industries (Europe) S.R.L.
Via TorriBianche n.1
20059 Vimercate(MB) Italy
Tel: +3903962 60 521
Fax: +39 039 96 31 409

U.S. Branch:

MOONS' Industries (America), Inc.
1113 North Prospect Avenue
Itasca, IL 60143 USA
Tel: +16308335940
Fax: +1 630 833 5946

South-East Asia Branch:

MOONS' Industries(South-East Asia)Pte Ltd.
33 Ubi Avenue 3 #08-23 Vertex
Singapore 408868
Tel: +6566341198
Fax: +65 6634 1138

MOONS' headquarters is in Shanghai China

