

8827100 & 88272100
QUICK DISCONNECT CONTACTS

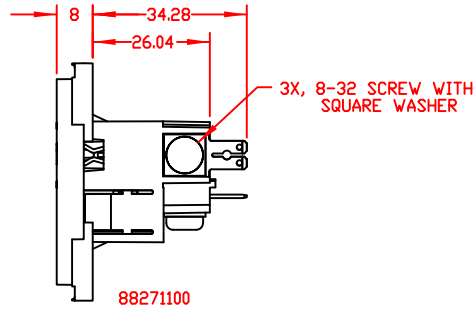

88271100

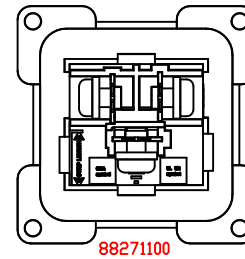

88271100

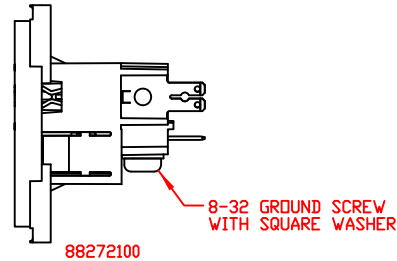

88272100

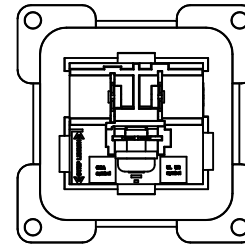

88272100

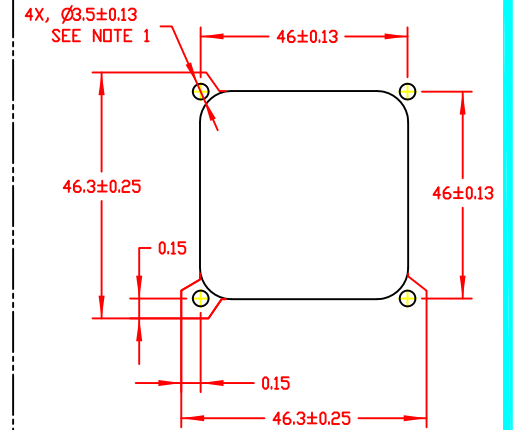

THIS PANEL CUTOUT IS RECOMMENDED WHEN USED IN COMBINATION WITH THE 88052XXX FAMILY OF SOCKETS

NOTES:
1. RECOMMENDED DIAMETER FOR THRU-HOLE (SCREW/NUT COMBINATION) HARDWARE MOUNTING METHOD. OTHER METHODS WILL REQUIRE HOLES WITH DIFFERENT DIMENSIONS AND PARAMETERS.

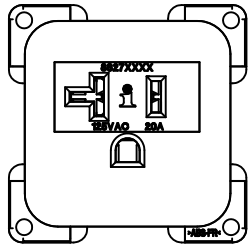

88273100 & 88274100
SOLDER TAB CONTACTS

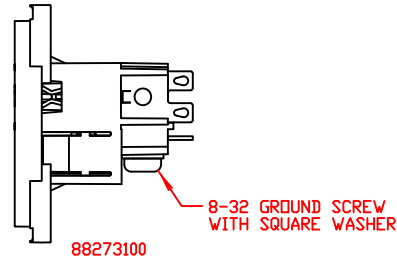

88273100

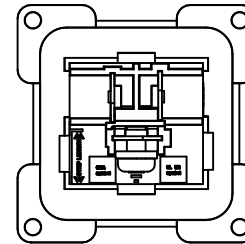

88273100

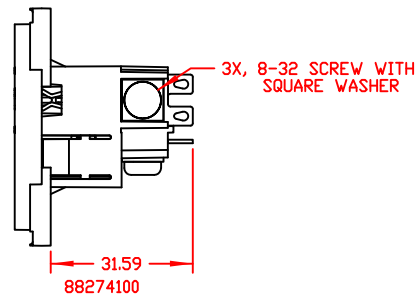

88274100

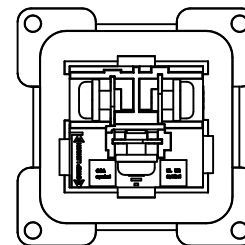

88274100

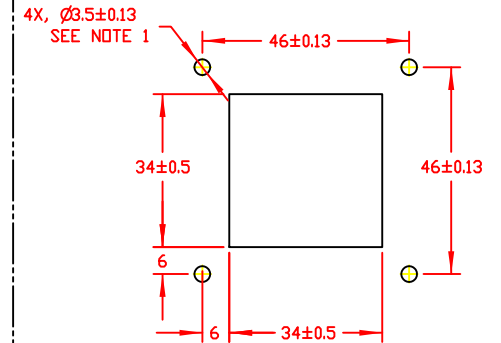

THIS PANEL CUTOUT IS RECOMMENDED FOR ALL OTHER APPLICATIONS

THIS DOCUMENT AND ITS CONTENTS ARE THE PROPRIETARY, CONFIDENTIAL PROPERTY OF INTERPOWER CORPORATION. NO USE OR COPIES MAY BE MADE WITHOUT WRITTEN PERMISSION FROM INTERPOWER.

DIMENSIONS IN: MM

TITLE BLACK NEMA 5-20 SCREW MOUNT ASSEMBLIES

DRAFT BY: BEM DATE: 9-30-13

PART NUMBER: 88271100, 88272100
88273100, 88274100

DRAFTING APPROVAL: SRK DATE: 9-30-13

MATERIAL:

DO NOT SCALE

SHEET 1 OF 1

INTERPOWER CORPORATION

1	2	INITIAL RELEASE	10/08/13	DDF
2D	3D	CHANGE DESCRIPTION	DATE	BY
REV				