

ANT-LTE-MON-SMA-L

Enhanced Low-Band LTE Connectorized Monopole Whip Antenna

The MON-L antenna is a member of Linx’s LTE-MON family of compact rotatable hinged-whip antennas which offer optimized support for a wide range of cellular LTE and IoT applications.

The MON-L antenna provides excellent multiband cellular and cellular IoT performance. It offers better VSWR at the lower LTE frequency bands, including LTE Band 71 (617 MHz to 698 MHz), on a smaller ground plane than competitive products. This equates to better range in a smaller product design.

The hinged design allows for the antenna to be positioned for optimum performance and reduces the potential for damage from impact compared to a fixed whip design.



Features

- Enhanced low-band coverage (LTE B71)
 - Efficiency: 73%
 - VSWR: ≤ 3.3
 - Peak Gain: 3.4 dBi
- Covers all common LTE/4G/3G/2G bands
- Hinged for optimum positioning
- Small, unobtrusive profile, 78.7 mm long
- Extended temperature range to 130 °C
- SMA plug (male pin)

Applications

- Cellular IoT: LTE-M (Cat-M1) and NB-IoT
 - T-Mobile: band 71
 - AT&T: bands 12, 14, 17
 - Verizon: band 13
 - Europe: bands 8, 20
 - Latin America: bands 5, 28
 - Asia Pacific: bands 5, 8, 20, 28
- Worldwide LTE, UMTS and GSM
- Low-power, wide-area (LPWA) applications
 - LoRaWAN®
 - Sigfox®
- Citizens Broadband Radio Service (CBRS)
- ISM: Bluetooth® and ZigBee®
- FirstNet® Public Safety
- Internet of Things (IoT) devices
- Gateways

Ordering Information

Part Number	Description
ANT-LTE-MON-SMA-L	Antenna with SMA plug (male pin)

Available from Linx Technologies and select distributors and representatives.

Electrical Specifications

Select Bands	Frequency Range	VSWR (max.)	Peak Gain (dBi)	Avg. Gain (dBi)	Efficiency (%)
LTE 71	617 MHz to 698 MHz	3.3	3.4	-1.5	73
LTE 12, 13, 14, 17, 26, 28, 29	698 MHz to 803 MHz	2.2	4.8	-0.7	90
LTE 5, 8, 20	791 MHz to 960 MHz	2.6	5.0	-1.1	90
LTE 1, 2, 3, 4, 25, 66	1710 MHz to 2200 MHz	3.2	3.9	-1.6	72
LTE 30, 40	2300 MHz to 2400 MHz	2.3	3.4	-1.2	77
LTE 7, 41	2496 MHz to 2690 MHz	1.9	4.1	-1.1	79
LTE 22, 42, 52, 43, 48, 49	3300 MHz to 3800 MHz	2.2	4.6	-2.4	64
ISM	2400 MHz to 2485 MHz	2.1	3.2	-1.4	74

Polarization	Linear	Impedance	50 Ω
Radiation	Omnidirectional	Connection	SMA Plug (male pin)
Max Power	10 W	Weight	10.0 g (0.35 oz)
Wavelength	1/4-wave	Dimensions	78.7 mm (3.1 in)
Electrical Type	Monopole	Operating Temperature	-40 °C to +130 °C

Electrical specifications and plots measured with a 102 mm x 102 mm (4.0 in x 4.0 in) reference ground plane, edge straight orientation.

Product Dimensions

Figure 1 provides dimensions of the MON-L. The antenna whip can be tilted 180 degrees, and has detents every 45 degrees enabling the antenna to be oriented in any direction. The rotating base allows for continuous positioning through 360 degrees even while installed.

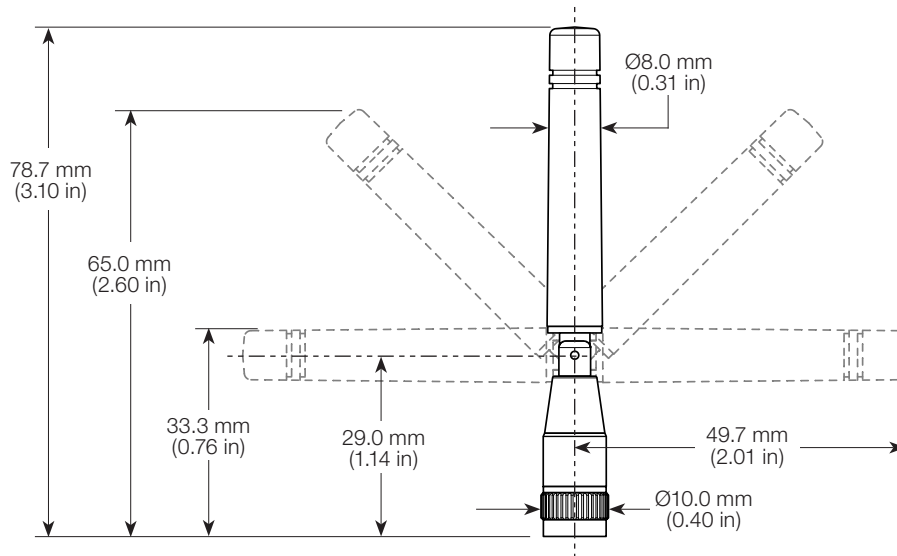

Figure 1. ANT-LTE-MON-SMA-L Antenna Dimensions

Ground Plane

1/4-Wave monopole antennas require an associated ground plane counterpoise for proper operation. The size and location of the ground plane relative to the antenna will affect the overall performance of the antenna in the final design. When used in conjunction with a ground plane smaller than that used to tune the antenna, the center frequency typically will shift higher in frequency and the bandwidth will decrease. The proximity of other circuit elements and packaging near the antenna will also affect the final performance.

For further discussion and guidance on the importance of the ground plane counterpoise, please refer to Linx Application Note, *AN-00501: Understanding Antenna Specifications and Operation*.

Antenna Orientation

The MON-L antenna is characterized in two antenna orientations on a 102 mm x 102 mm ground plane as shown in Figure 2. The two orientations, with the antenna straight and bent 90 degrees, represent the most common orientations in end-product use.

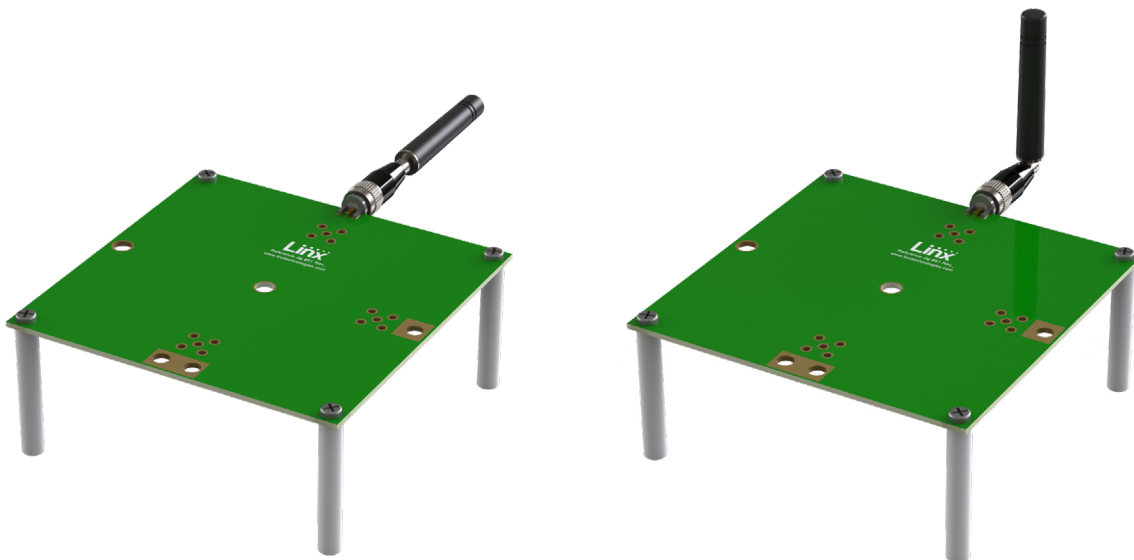

On edge of ground plane, straight

On edge of ground plane, bent 90 degrees

Figure 2. ANT-LTE-MON-SMA-L on Evaluation PCB

Edge of Ground Plane, Straight

The charts on the following pages represent data taken with the antenna oriented at the edge of the ground plane, straight (Edge-Straight), as shown in Figure 3.

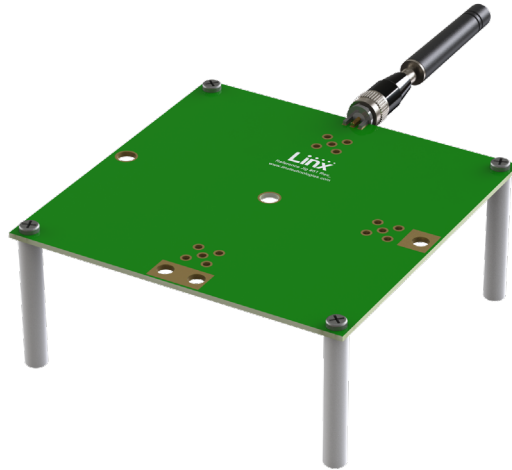

Figure 3. ANT-LTE-MON-SMA-L on Edge of Ground Plane, Straight (Edge-Straight)

VSWR

Figure 4 provides the voltage standing wave ratio (VSWR) across the antenna bandwidth. VSWR describes the power reflected from the antenna back to the radio. A lower VSWR value indicates better antenna performance at a given frequency. Reflected power is also shown on the right-side vertical axis as a gauge of the percentage of transmitter power reflected back from the antenna.

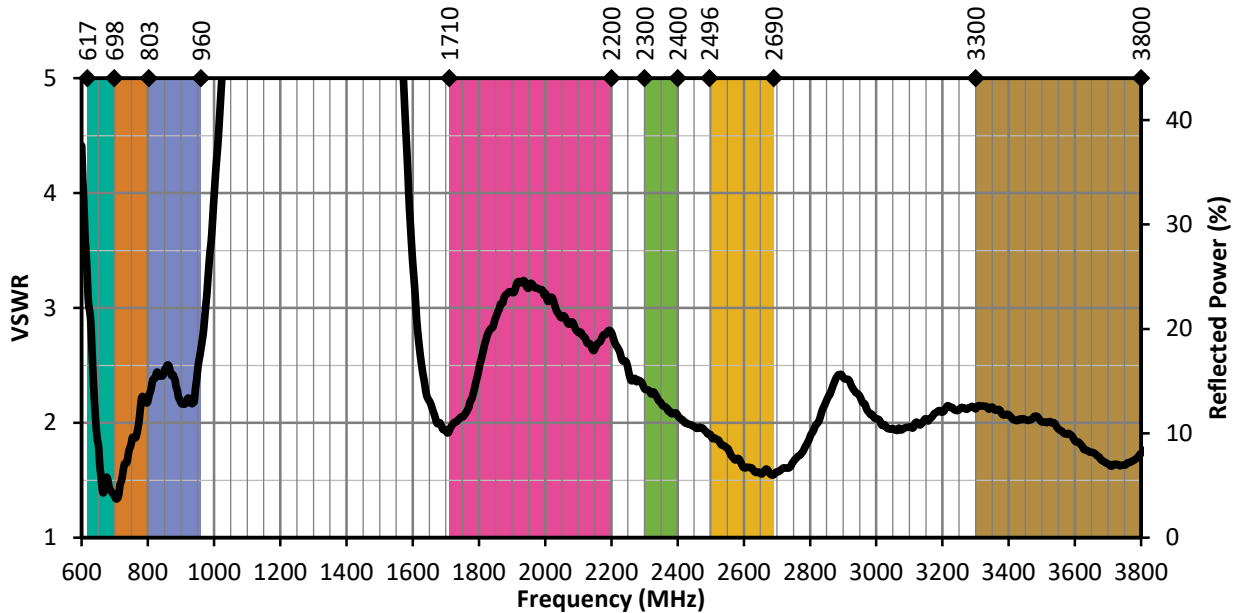

Figure 4. MON-L VSWR, Edge-Straight, with Frequency Band Highlights

Return Loss

Return loss (Figure 5), represents the loss in power at the antenna due to reflected signals. Like VSWR, a lower return loss value indicates better antenna performance at a given frequency.

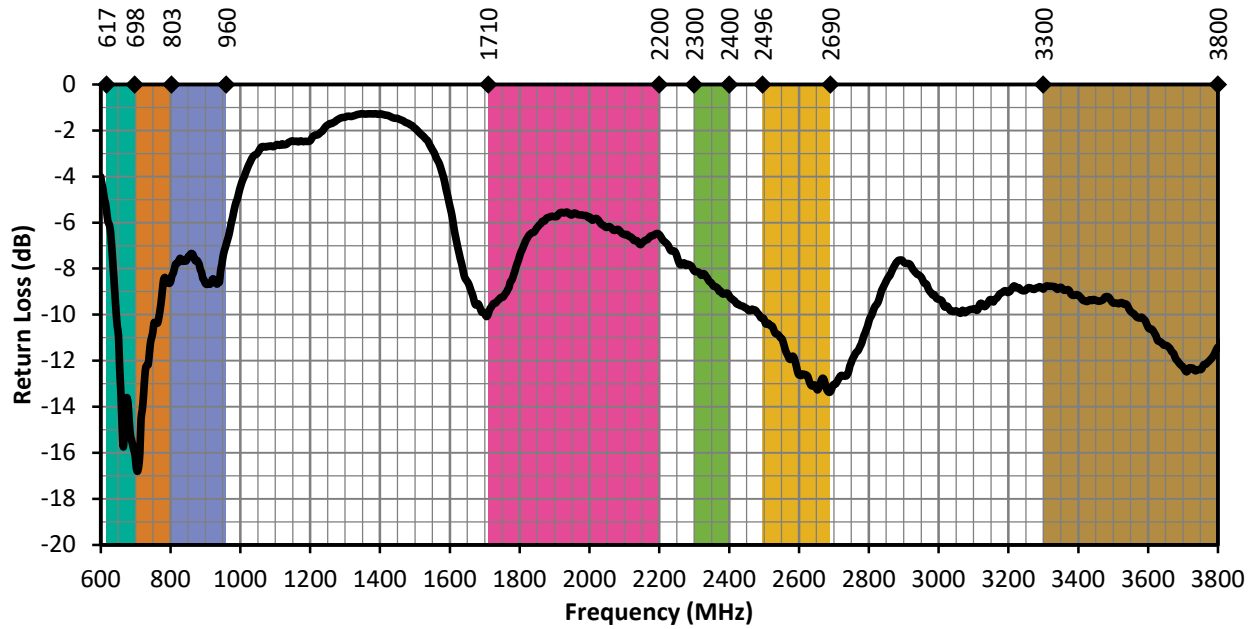

Figure 5. MON-L Return Loss, Edge-Straight, with Frequency Band Highlights

Peak Gain

The peak gain across the antenna bandwidth is shown in Figure 6. Peak gain represents the maximum antenna input power concentration across 3-dimensional space, and therefore peak performance at a given frequency, but does not consider any directionality in the gain pattern.

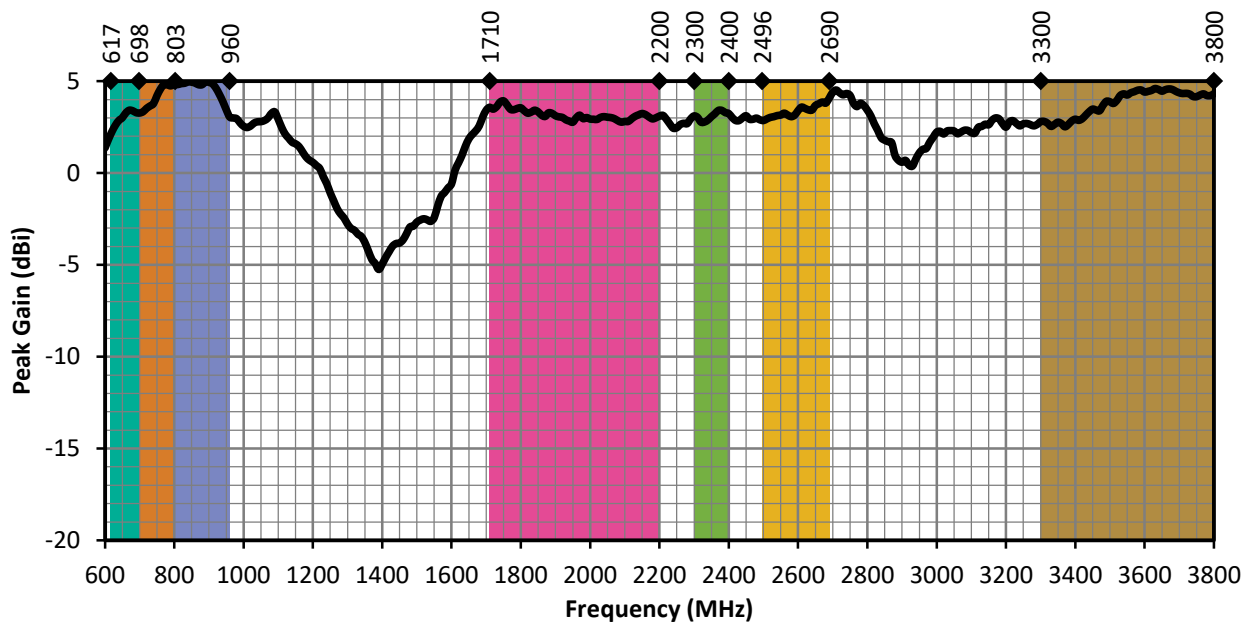

Figure 6. MON-L Peak Gain, Edge-Straight, with Frequency Band Highlights

Average Gain

Average gain (Figure 7), is the average of all antenna gain in 3-dimensional space at each frequency, providing an indication of overall performance without expressing antenna directionality.

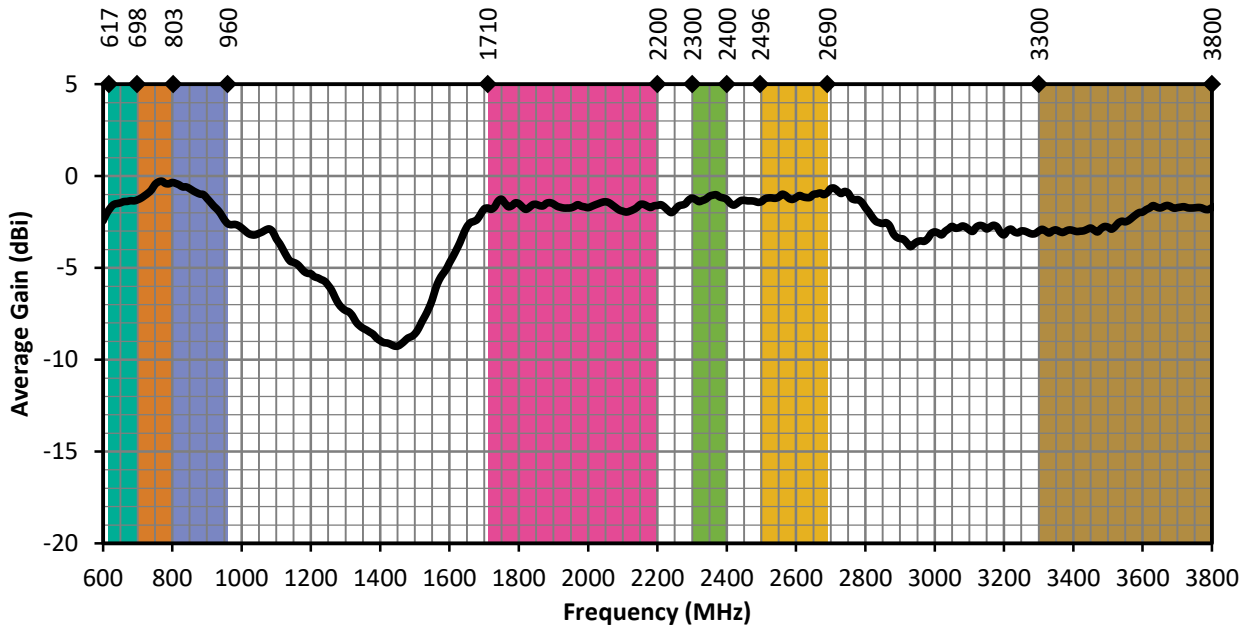

Figure 7. MON-L Antenna Average Gain, Edge-Straight, with Frequency Band Highlights

Radiation Efficiency

Radiation efficiency (Figure 8), shows the ratio of power delivered to the antenna relative to the power radiated at the antenna, expressed as a percentage, where a higher percentage indicates better performance at a given frequency.

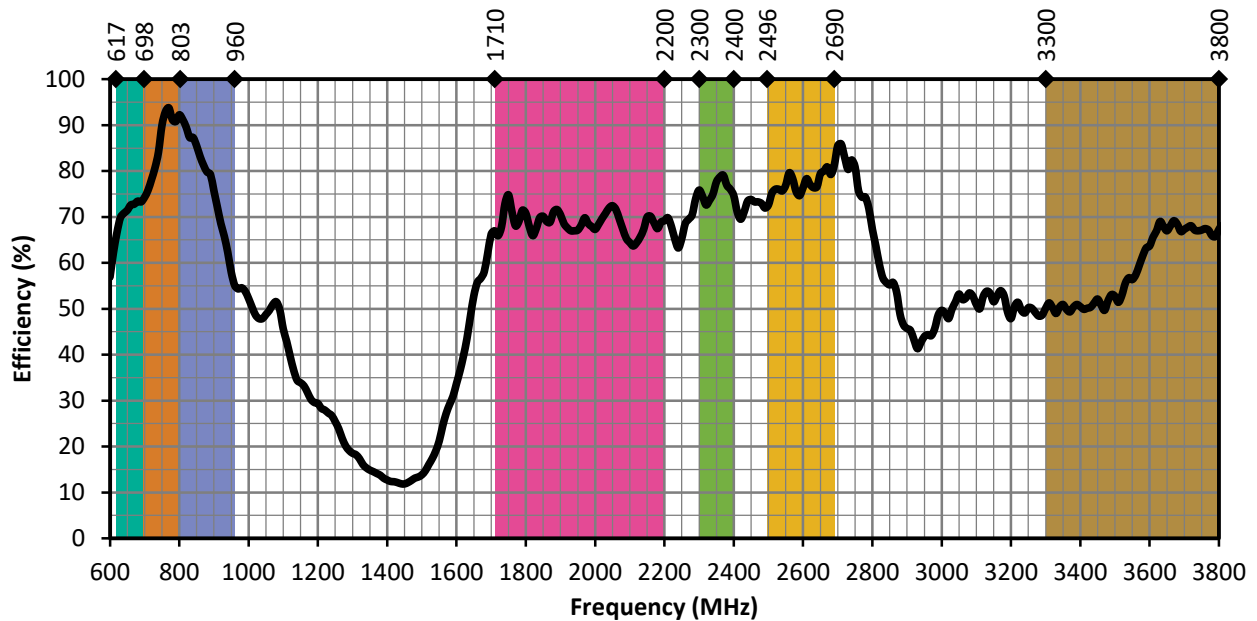
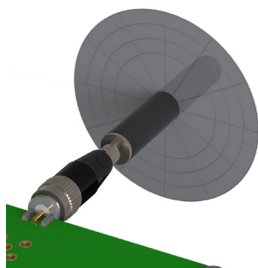

Figure 8. MON-L Antenna Radiation Efficiency, Edge-Straight, with Frequency Band Highlights

Radiation Patterns

Radiation patterns provide information about the directionality and 3-dimensional gain performance of the antenna by plotting gain at specific frequencies in three orthogonal planes. Antenna radiation patterns for an edge straight orientation are shown in Figure 9 using polar plots covering 360 degrees. The antenna graphic at the top of the page provides reference to the plane of the column of plots below it. Note: when viewed with typical PDF viewing software, zooming into radiation patterns is possible to reveal fine detail.

Radiation Patterns - Edge of Ground Plane, Straight



XZ-Plane Gain

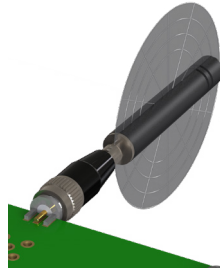

YZ-Plane Gain

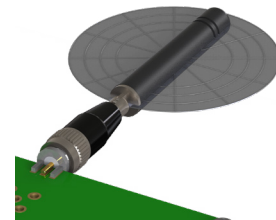

XY-Plane Gain

610 MHz to 700 MHz (660 MHz)

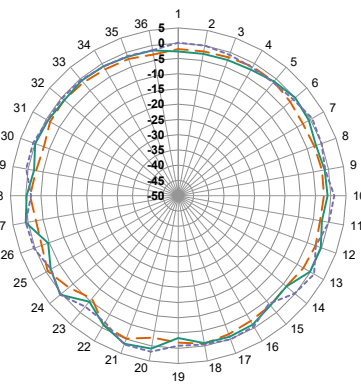

XZ-Plane Gain

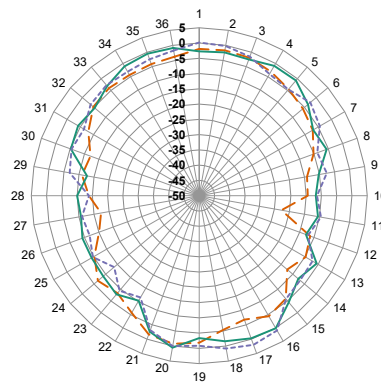

YZ-Plane Gain

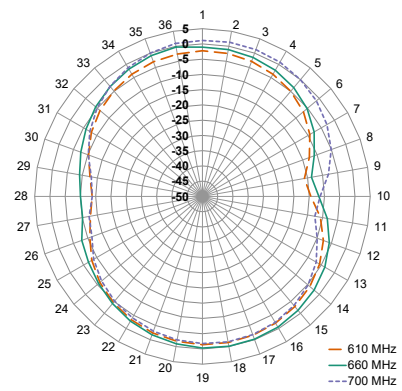

XY-Plane Gain

700 MHz to 800 MHz (750 MHz)

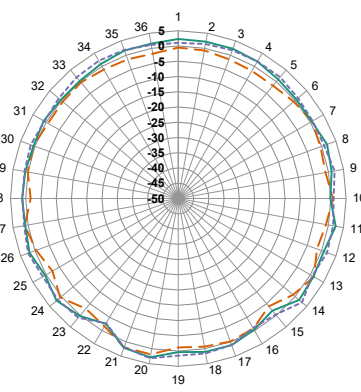

XZ-Plane Gain

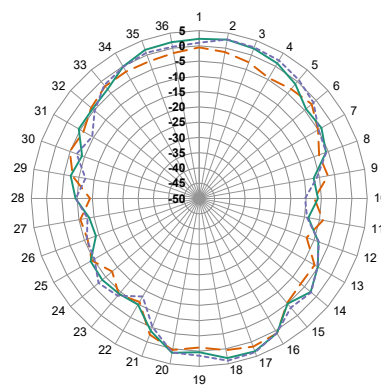

YZ-Plane Gain

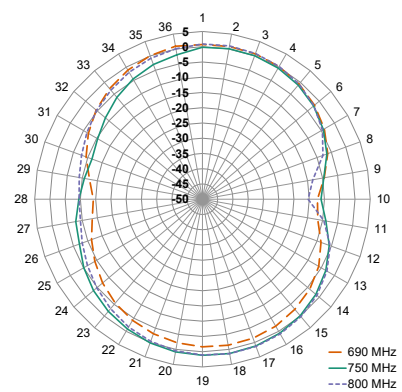

XY-Plane Gain

Radiation Patterns - Edge of Ground Plane, Straight
790 MHz to 960 MHz (870 MHz)

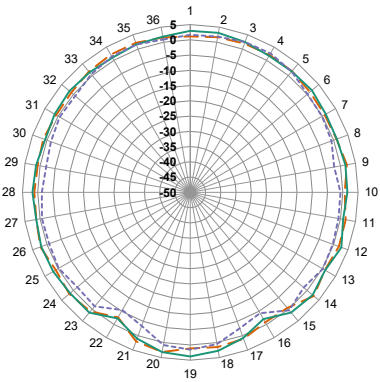

XZ-Plane Gain

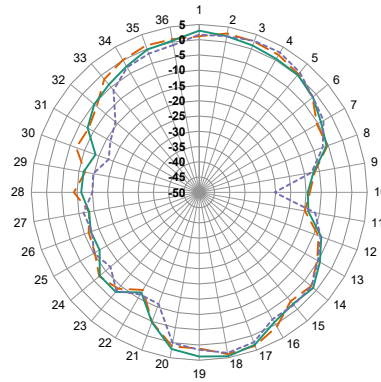

YZ-Plane Gain

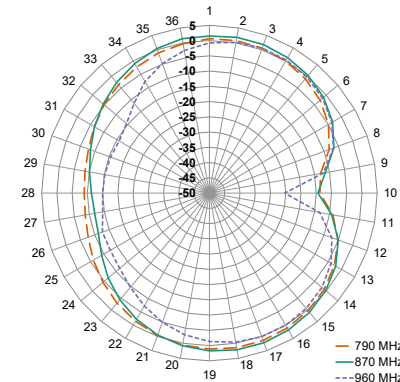

XY-Plane Gain

— 790 MHz
— 870 MHz
- - 960 MHz

1710 MHz to 2200 MHz (1940 MHz)

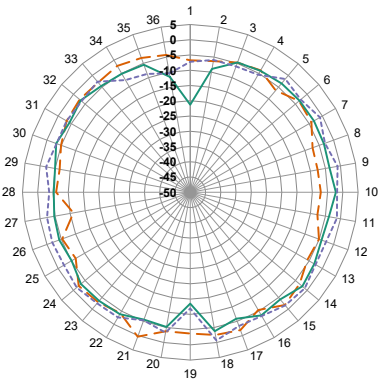

XZ-Plane Gain

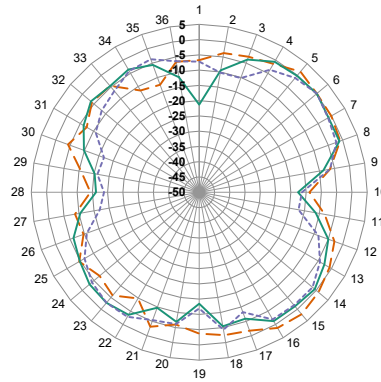

YZ-Plane Gain

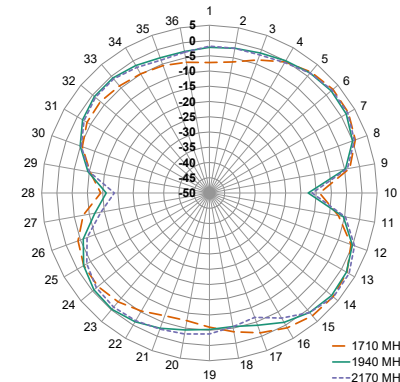

XY-Plane Gain

— 1710 MHz
— 1940 MHz
- - 2170 MHz

2300 MHz to 2400 MHz (2350 MHz)

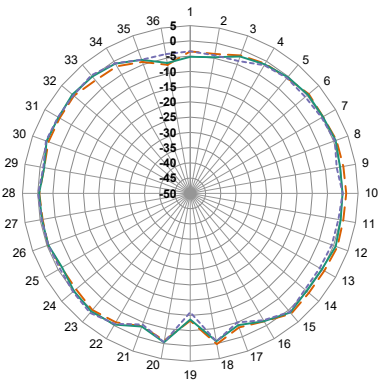

XZ-Plane Gain

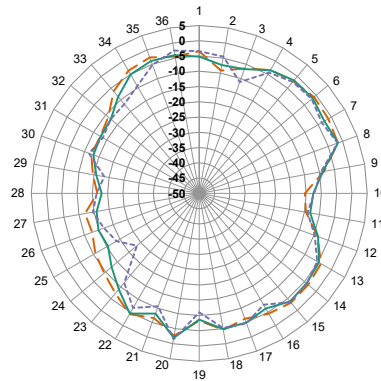

YZ-Plane Gain

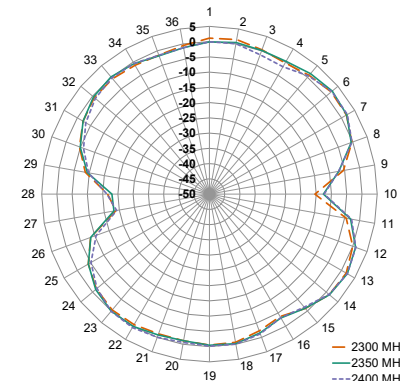

XY-Plane Gain

— 2300 MHz
— 2350 MHz
- - 2400 MHz

Radiation Patterns - Edge of Ground Plane, Straight
2496 MHz to 2690 MHz (2450 MHz)

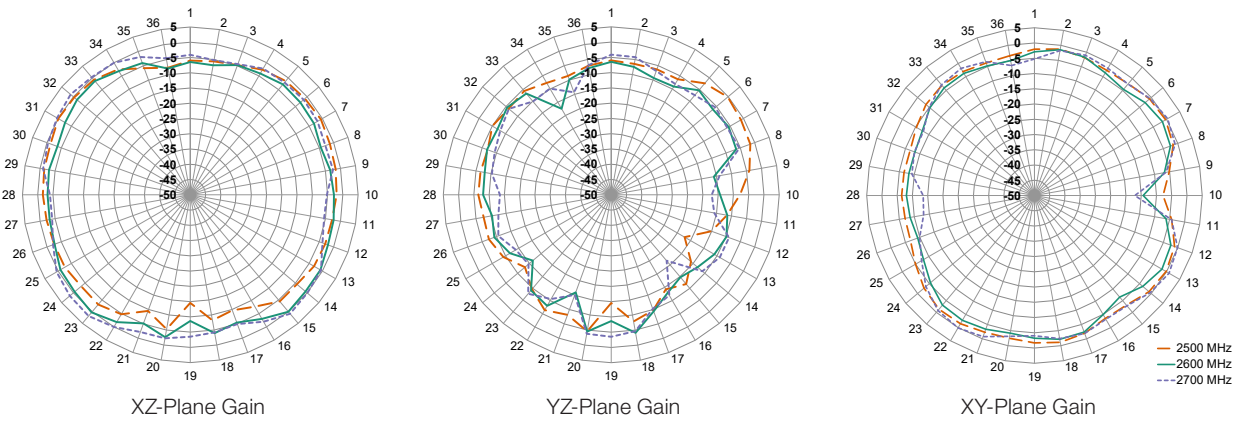

3300 MHz to 3800 MHz (3550 MHz)

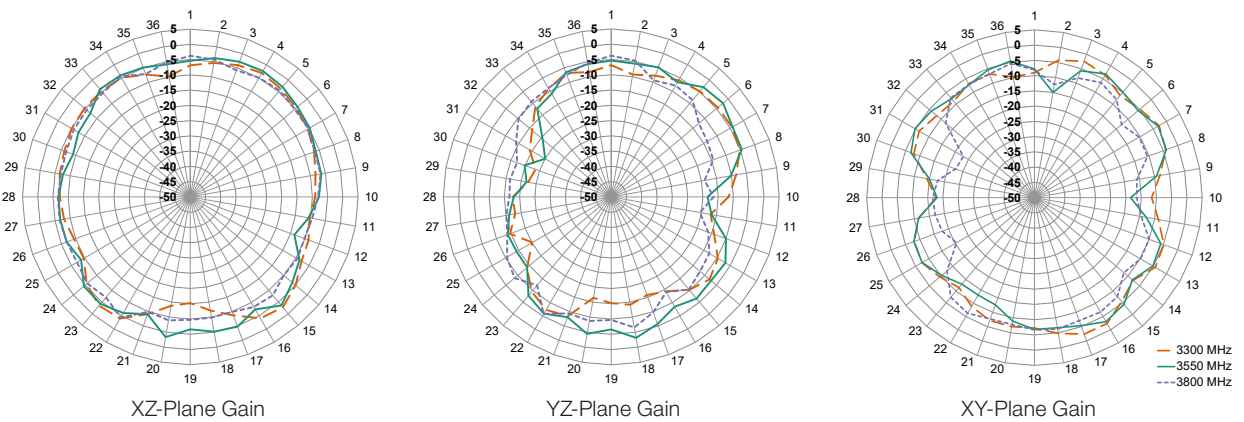

2400 MHz to 2500 MHz (2450 MHz)

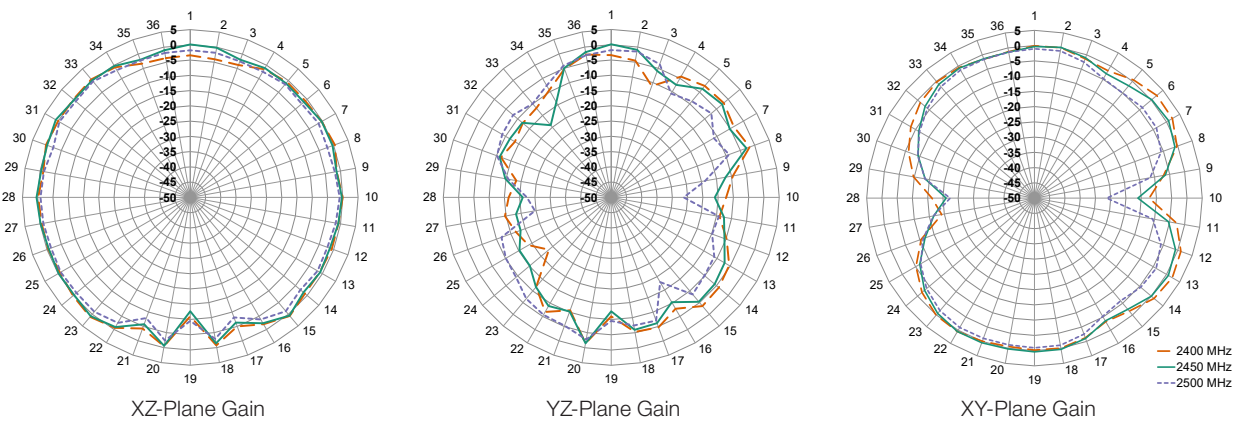

Figure 9. Radiation Patterns for MON-L on Edge of Ground Plane, Straight

Edge of Ground Plane, Bent 90 degrees

The charts on the following pages represent data taken with the antenna oriented at the edge of the ground plane, bent 90 degrees (Edge-Bent), as shown in Figure 10.

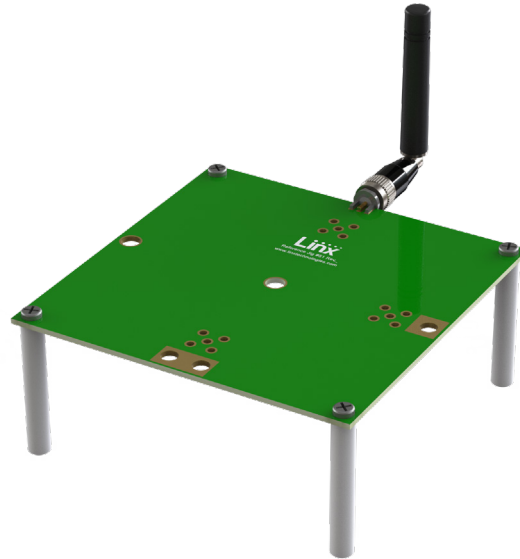

Figure 10. ANT-LTE-MON-SMA-L on Edge of Ground Plane, Bent 90 Degrees (Edge-Bent)

VSWR

Figure 11 provides the voltage standing wave ratio (VSWR) across the antenna bandwidth. VSWR describes the power reflected from the antenna back to the radio. A lower VSWR value indicates better antenna performance at a given frequency. Reflected power is also shown on the right-side vertical axis as a gauge of the percentage of transmitter power reflected back from the antenna.

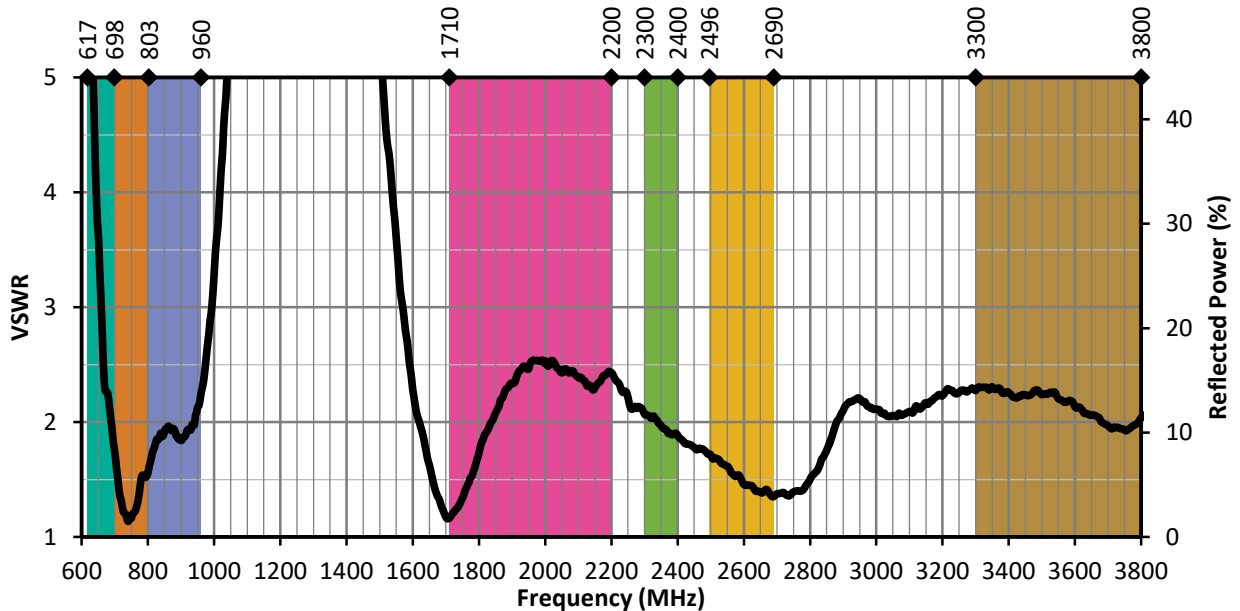

Figure 11. MON-L VSWR, Edge-Bent, with Frequency Band Highlights

Return Loss

Return loss (Figure 12), represents the loss in power at the antenna due to reflected signals. Like VSWR, a lower return loss value indicates better antenna performance at a given frequency.

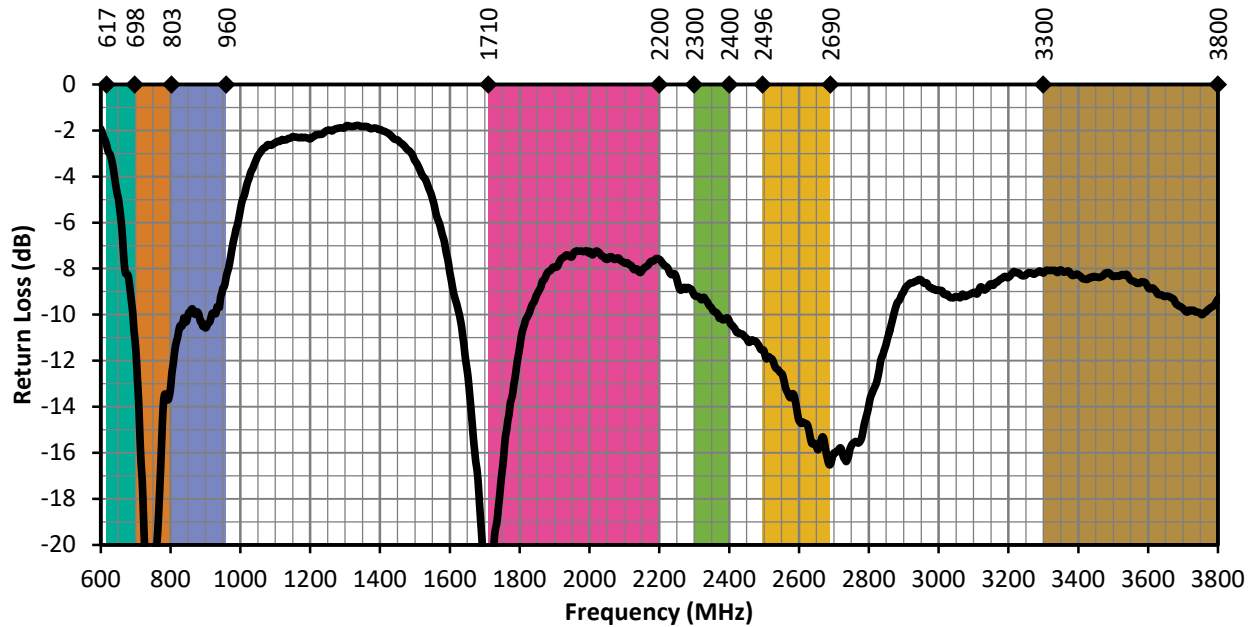

Figure 12. MON-L Return Loss, Edge-Bent, with Frequency Band Highlights

Peak Gain

The peak gain across the antenna bandwidth is shown in Figure 13. Peak gain represents the maximum antenna input power concentration across 3-dimensional space, and therefore peak performance at a given frequency, but does not consider any directionality in the gain pattern.

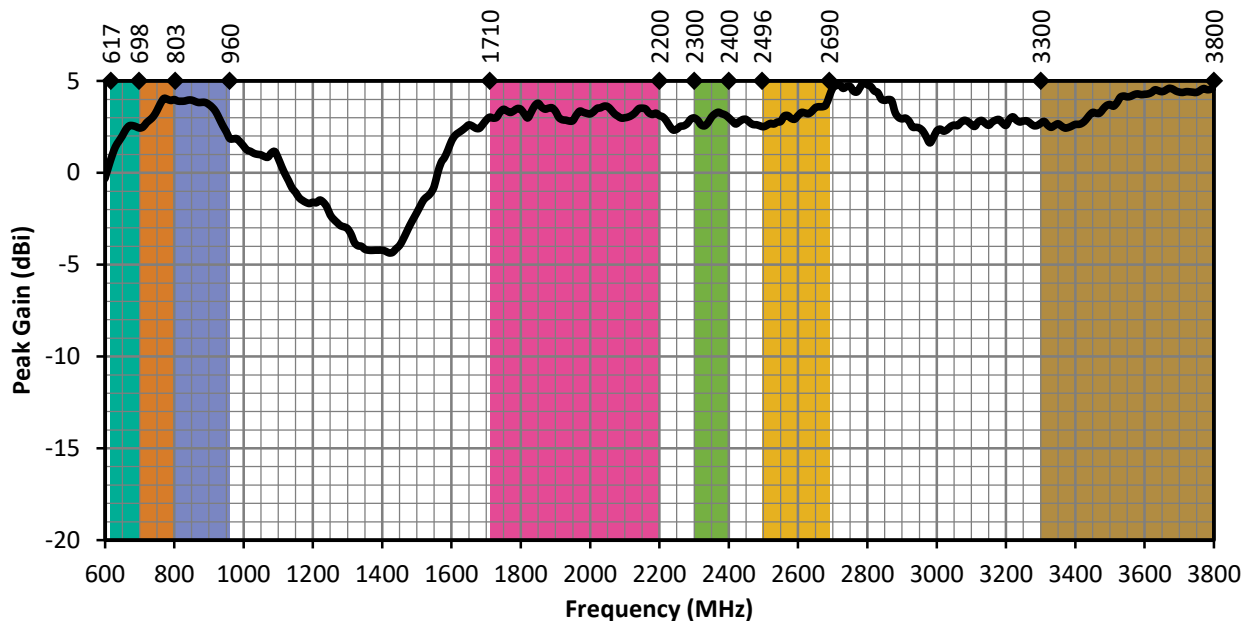

Figure 13. MON-L Peak Gain, Edge-Bent, with Frequency Band Highlights

Average Gain

Average gain (Figure 14), is the average of all antenna gain in 3-dimensional space at each frequency, providing an indication of overall performance without expressing antenna directionality.

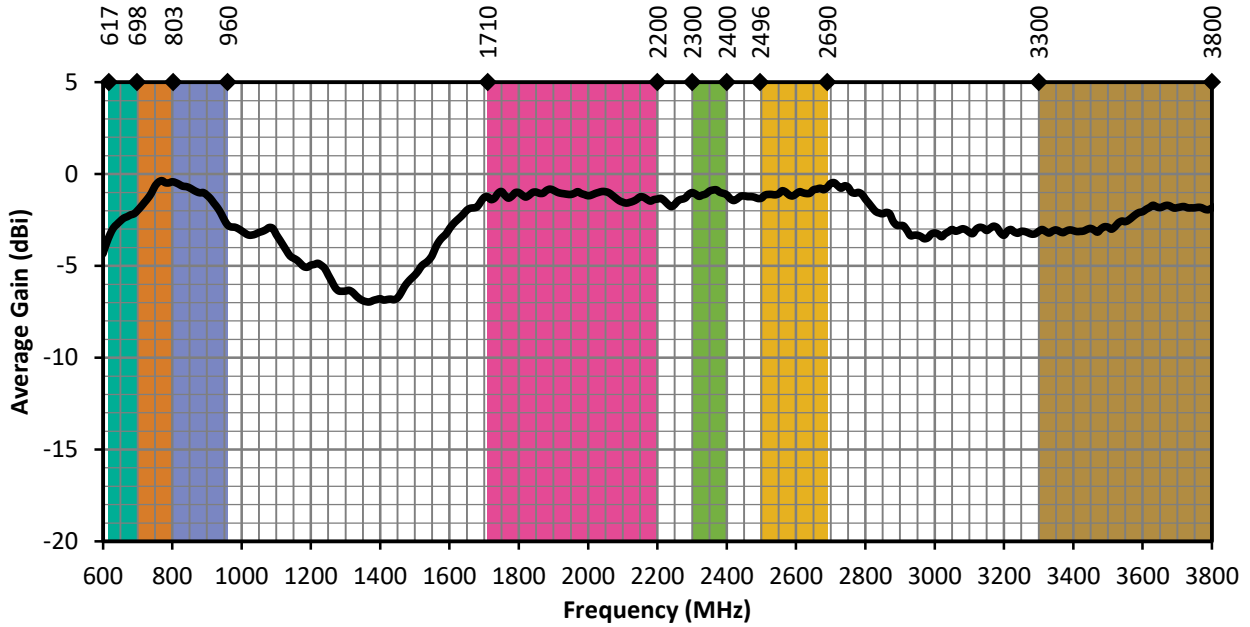

Figure 14. MON-L Antenna Average Gain, Edge-Bent, with Frequency Band Highlights

Radiation Efficiency

Radiation efficiency (Figure 15), shows the ratio of power delivered to the antenna relative to the power radiated at the antenna, expressed as a percentage, where a higher percentage indicates better performance at a given frequency.

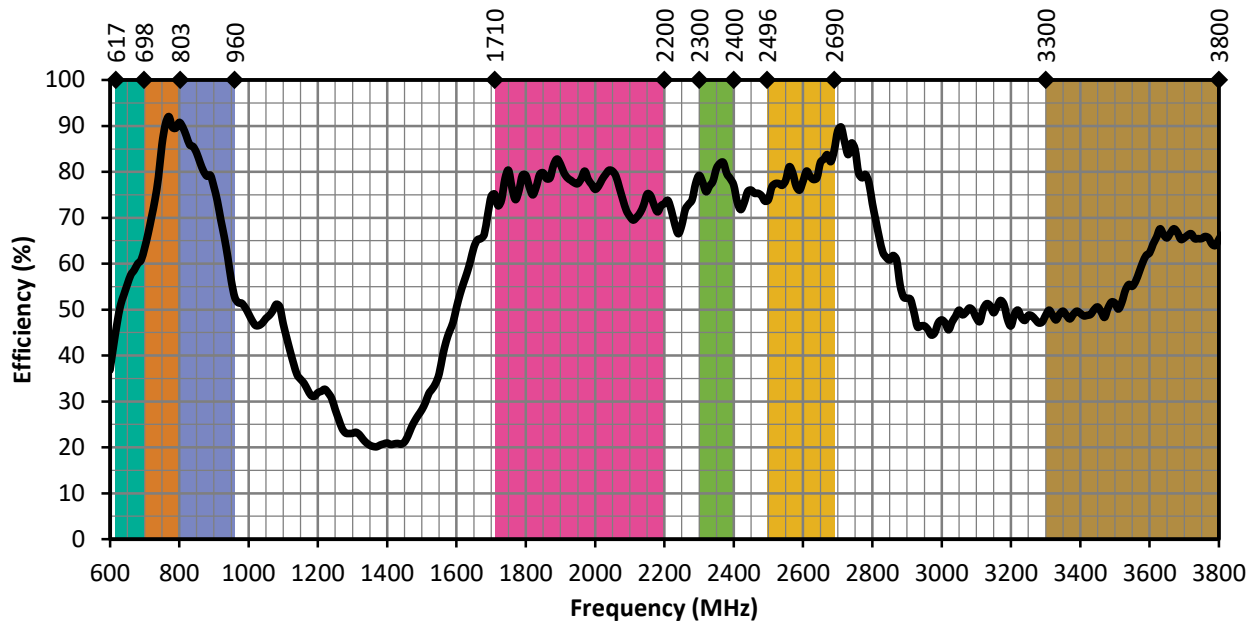

Figure 15. MON-L Antenna Radiation Efficiency, Edge-Bent, with Frequency Band Highlights

Radiation Patterns

Radiation patterns provide information about the directionality and 3-dimensional gain performance of the antenna by plotting gain at specific frequencies in three orthogonal planes. Antenna radiation patterns for a bent 90 degree orientation are shown in Figure 16 using polar plots covering 360 degrees. The antenna graphic at the top of the page provides reference to the plane of the column of plots below it. Note: when viewed with typical PDF viewing software, zooming into radiation patterns is possible to reveal fine detail.

Radiation Patterns - Edge of Ground Plane, Bent 90 Degrees



610 MHz to 700 MHz (660 MHz)

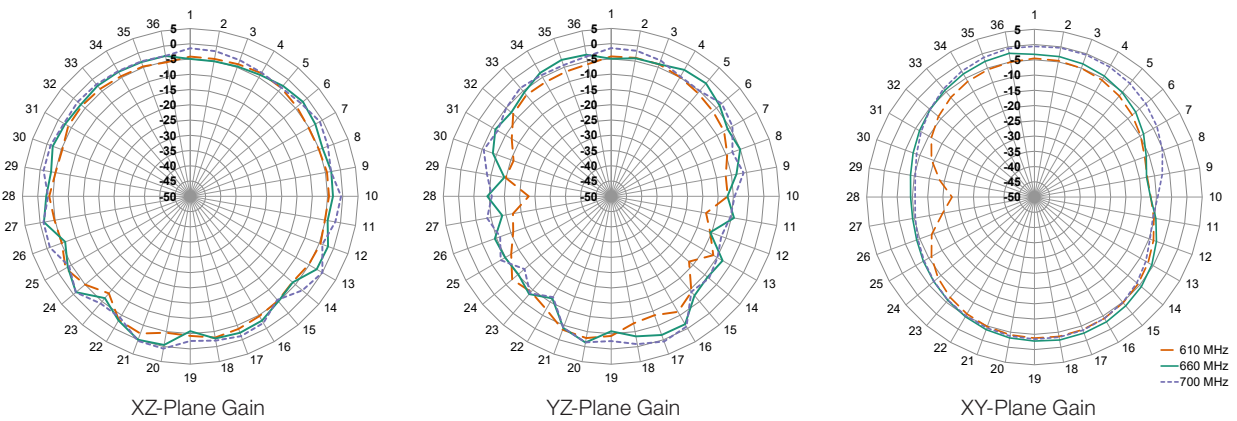

700 MHz to 800 MHz (750 MHz)

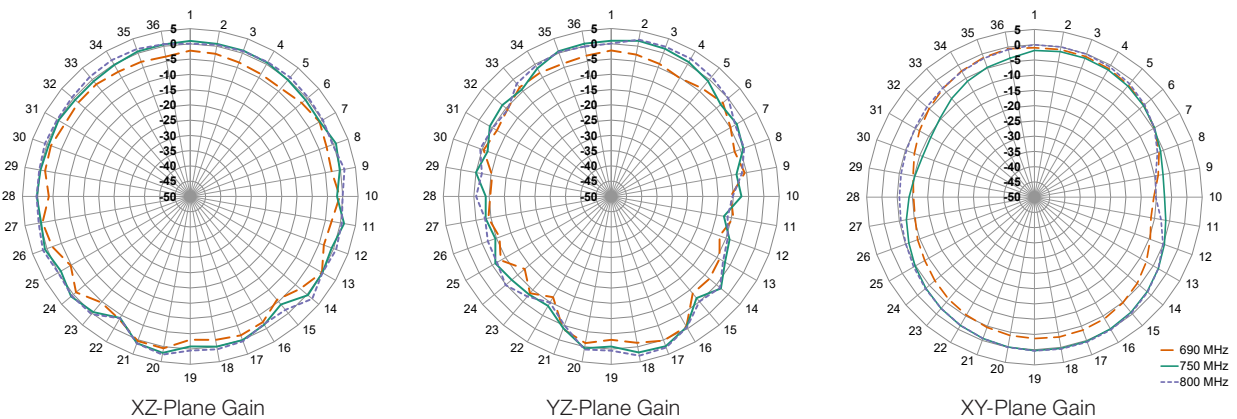

Radiation Patterns - Edge of Ground Plane, Bent 90 Degrees

790 MHz to 960 MHz (870 MHz)

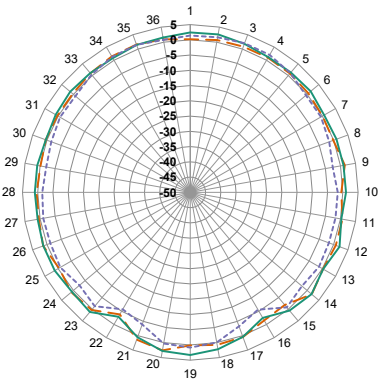

XZ-Plane Gain

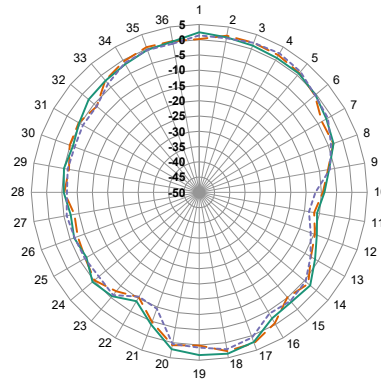

YZ-Plane Gain

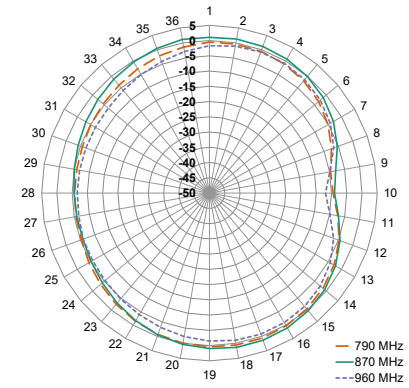

XY-Plane Gain

— 790 MHz
— 870 MHz
- - 960 MHz

1710 MHz to 2200 MHz (1940 MHz)

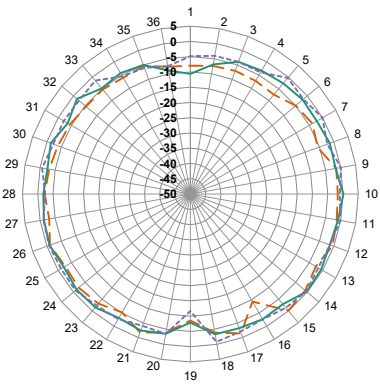

XZ-Plane Gain

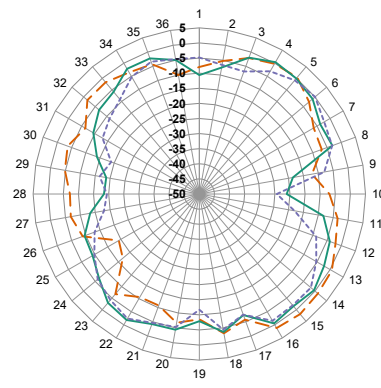

YZ-Plane Gain

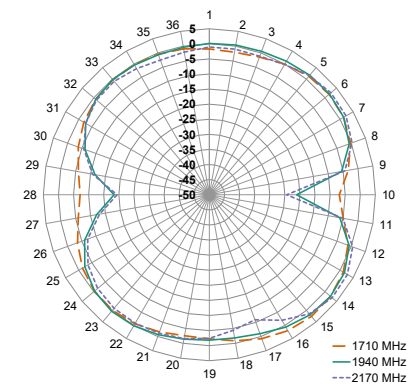

XY-Plane Gain

— 1710 MHz
— 1940 MHz
- - 2170 MHz

2300 MHz to 2400 MHz (2350 MHz)

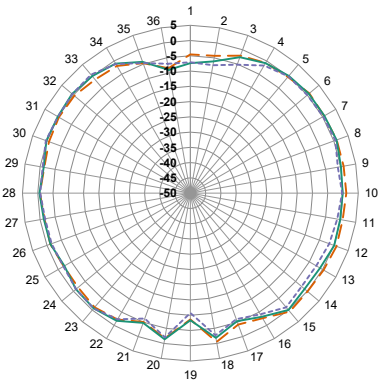

XZ-Plane Gain

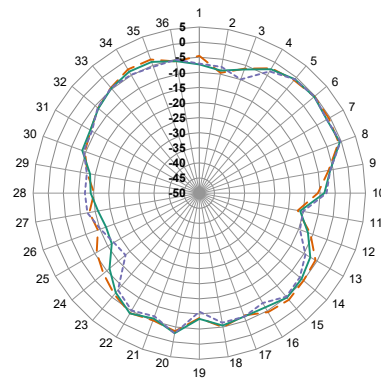

YZ-Plane Gain

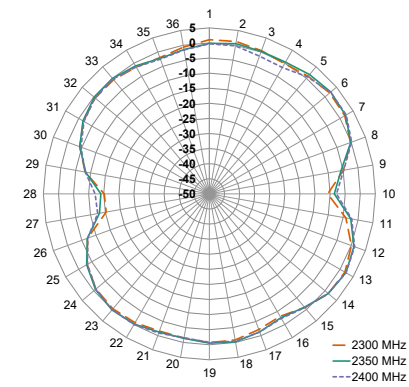

XY-Plane Gain

— 2300 MHz
— 2350 MHz
- - 2400 MHz

Radiation Patterns - Edge of Ground Plane, Bent 90 Degrees
2496 MHz to 2690 MHz (2600 MHz)

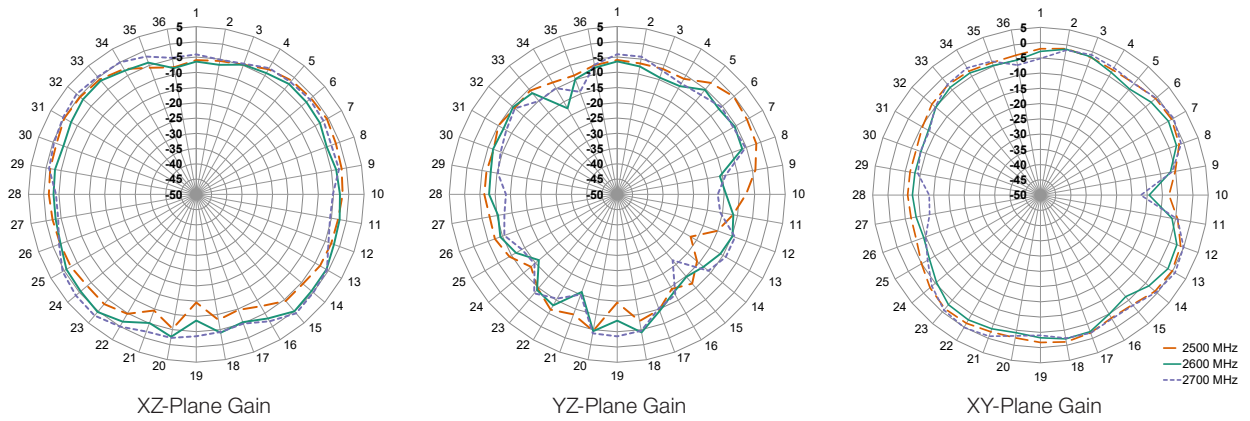

3300 MHz to 3800 MHz (3550 MHz)

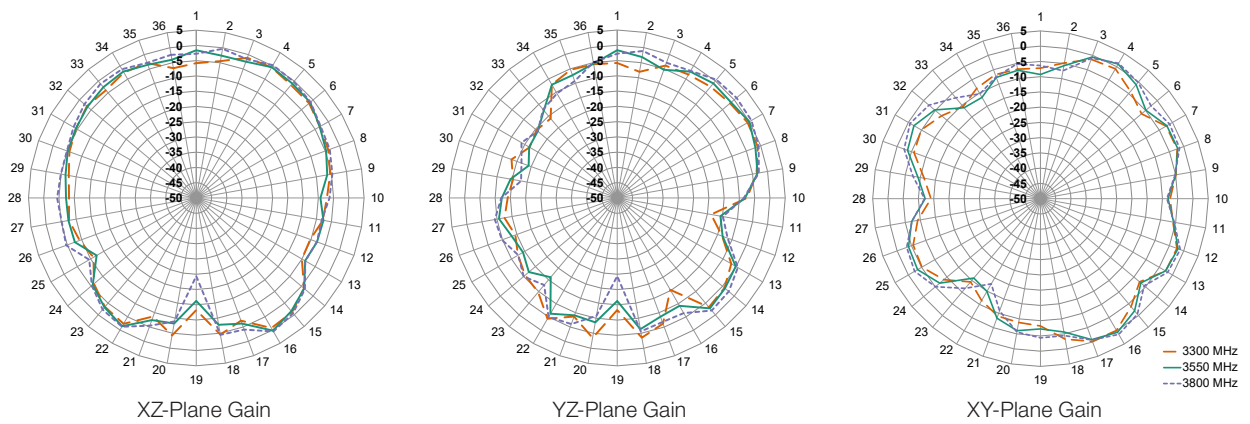

2400 MHz to 2500 MHz (2450 MHz)

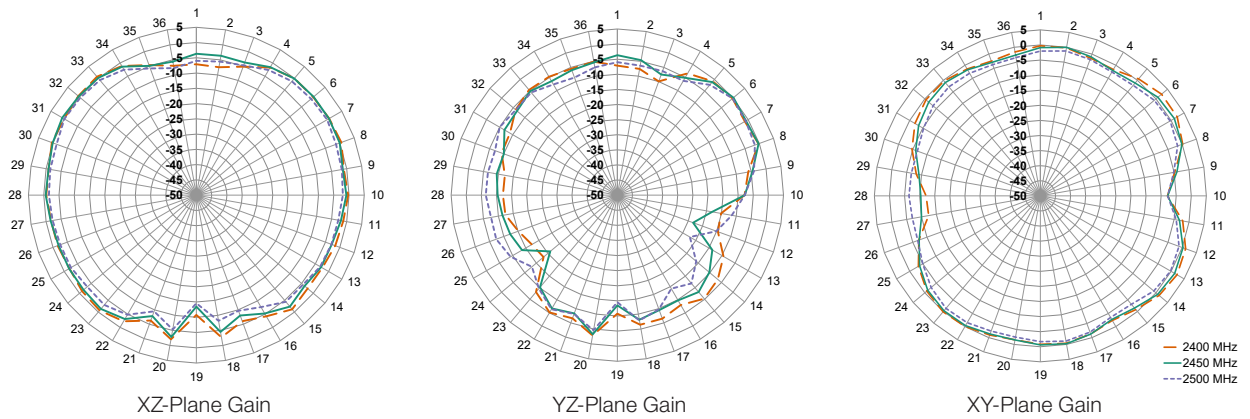

Figure 16. Radiation Patterns for MON-L on Edge of Ground Plane, Bent at 90 Degrees

Website: <http://linxtechnologies.com>
Linx Offices: 159 Ort Lane, Merlin, OR, US 97532
Phone: +1 (541) 471-6256
E-MAIL: info@linxtechnologies.com

Linx Technologies reserves the right to make changes to the product(s) or information contained herein without notice. No liability is assumed as a result of their use or application. No rights under any patent accompany the sale of any such product(s) or information.

Wireless Made Simple is a registered trademark of Linx Acquisitions LLC. Bluetooth is a registered trademark of Bluetooth SIG, Inc. FirstNet is a registered trademark of U.S. Department of Commerce, First Responder Network Authority. LoRaWAN is a registered trademark of Semtech Corporation. Sigfox is a registered trademark of SIGFOX. ZigBee is a registered trademark of ZigBee Alliance, Inc. Other product and brand names may be trademarks or registered trademarks of their respective owners.

Copyright © 2019 Linx Technologies

All Rights Reserved

Doc # DS19256-30ANT

