

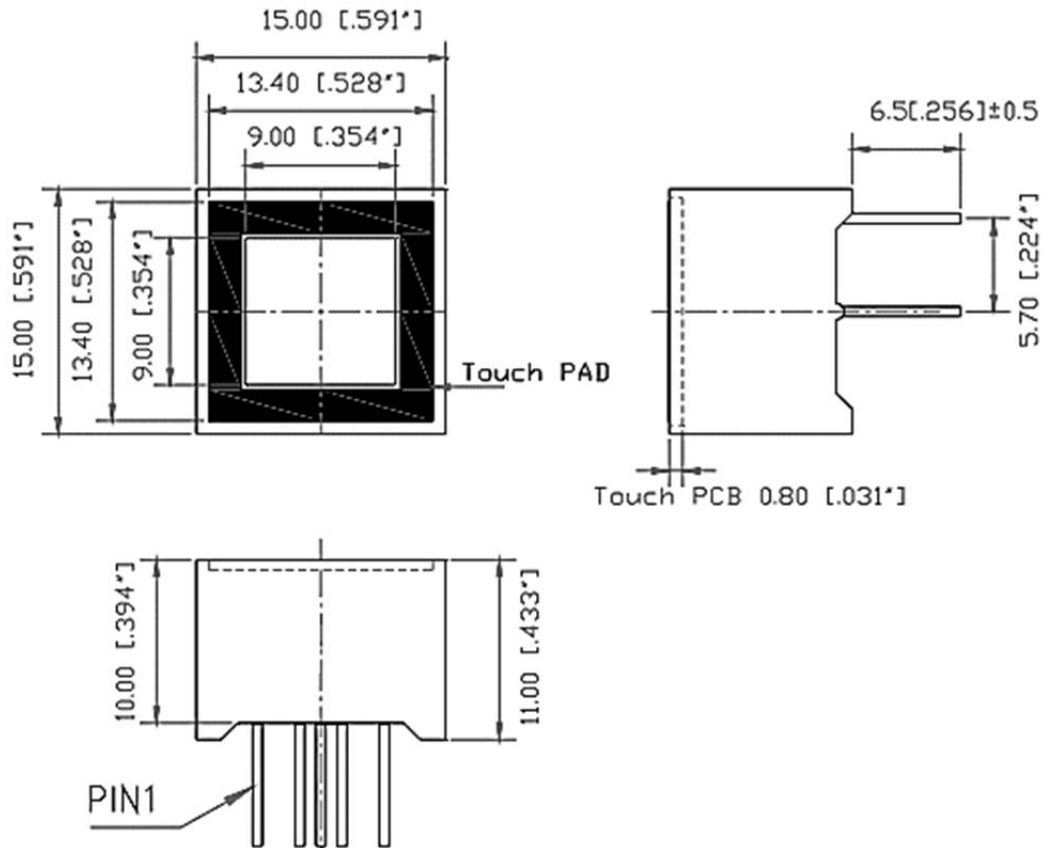

American Opto Plus LED Corp. CTD-IC591YPG-WW

15.0 x 15.0 x 11.0 mm Bi-Color Touch LED Display w/ Touch Drive IC

MECHANICAL DIMENSIONS



Notes:

1. All pins are 0.60[.024]±0.1[.004]
2. Dimension in millimeter [inch], tolerance is ±0.25 [.010] and unless otherwise noted.

Chip Material	Color	
	Emitter	Face/Segment
AlGaInP	Yellow	White/ White
InGaN	Prue Green	



American Opto Plus LED Corp. CTD-IC591YPG-WW

15.0 x 15.0 x 11.0 mm Bi-Color Touch LED Display w/ Touch Drive IC

ALL LIGHT ON SEGMENTS FEATURE & PIN POSITION

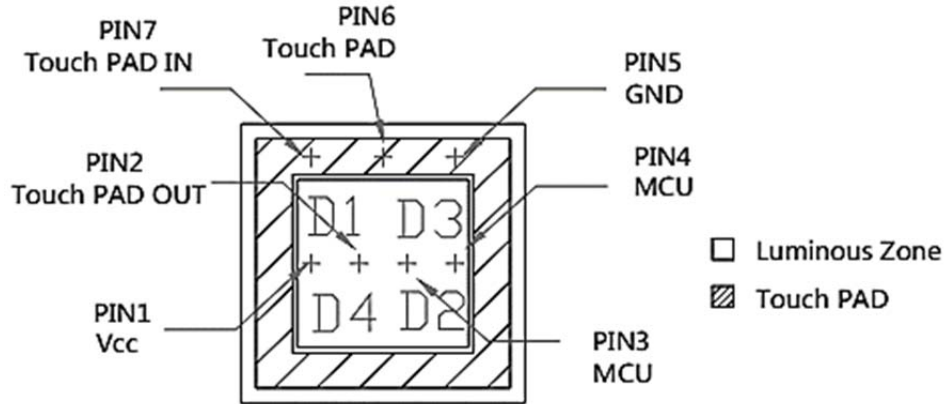

INTERNAL CIRCUIT DIAGRAMS

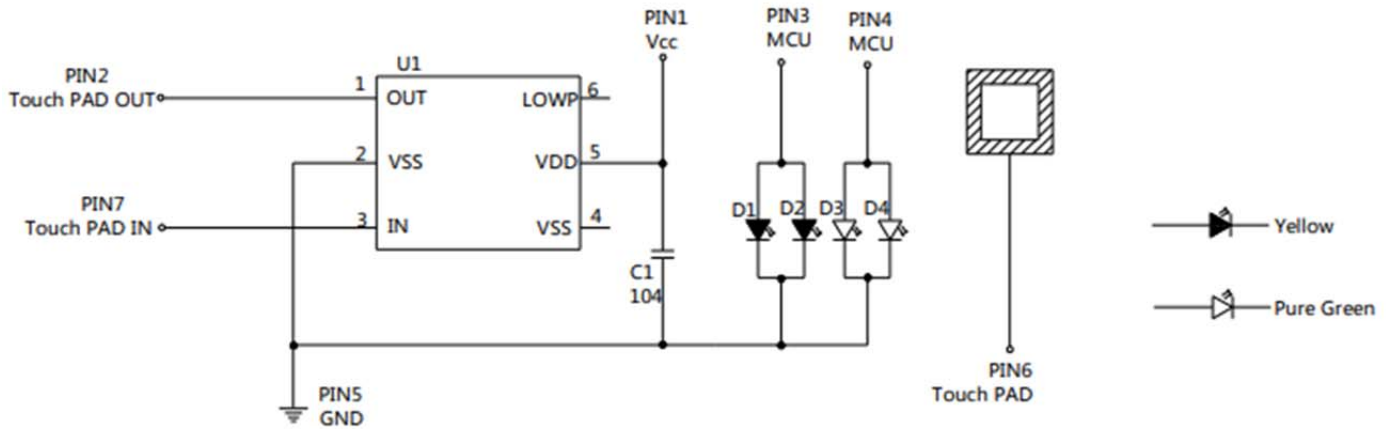

PIN 7 Layout connection to PIN 6

RECOMMENDED PCB LAYOUT

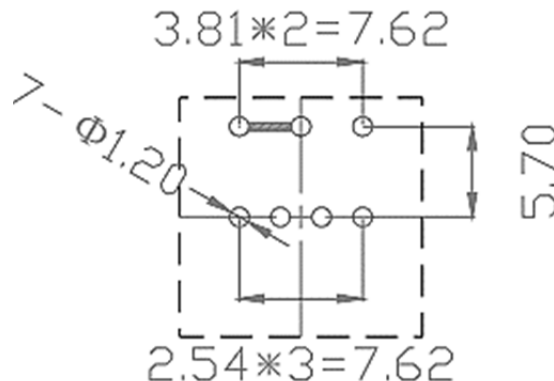



American Opto Plus LED Corp.

CTD-IC591YPG-WW

15.0 x 15.0 x 11.0 mm Bi-Color Touch LED Display w/ Touch Drive IC

TOUCH IC ELECTRO-OPTICAL CHARACTERISTICS

(Ta=25°C)

Parameter	Symbol	Condition	Min.	Typ.	Max.	Unit
Supply Voltage	VDD	--	2.0	--	5.5	V
High Level Input Voltage	VIH	@VDD=5V	3.5	--	5	V
Low Level Input Voltage	VIL		0	--	1.5	V
Operating Current	IDD1	@VDD=5V, no load	--	16	--	μA
		VDD=3V, no load	--	3.5	--	
Operating Current (SLRT=VDD)	IDD2	@VDD=5V, no load	--	10.5	--	μA
		@VDD=3V, no load	--	2.5	--	
Low Level Output Current	IOL	VDD=3V, VOL=1V	--	30	--	mA
High Level Output Current	IOH	VDD=3V, VOH=2V	--	8	--	mA



American Opto Plus LED Corp.

CTD-IC591YPG-WW

15.0 x 15.0 x 11.0 mm Bi-Color Touch LED Display w/ Touch Drive IC

ABSOLUTE MAXIMUM RATING

(Ta=25°C)

Parameter	Symbol	Rating		Unit
		Y	PG	
Power Dissipation Per Dice	PD	70	114	mW
Derating Liner from 25°C per Dice	-	0.33	0.4	mA/°C
Continuous Forward Current Per Dice	IF	25	30	mA
Peak Current Per Dice (duty cycle 1/10,1KHz)	IFP	90	100	mA
Reverse Voltage Per Dice	VR	5	5	V
Electrostatic Discharge (HBM)	ESD	--	1000	V
Operating Temp.	Topr	-35 ~ +85		°C
Storage Temp.	Tstg	-35 ~ +85		°C
Hand Soldering Temperature	Tsol	350		°C

ELECTRO-OPTICAL CHARACTERISTICS

(Ta=25°C)

Parameter	Symbol	Min.	Typ.	Max.	Unit	Condition
Luminous Intensity	IV	Y	--	90	--	mcd
		PG	--	612	--	
Forward Voltage	VF	Y	--	2.1	2.8	V
		PG	--	3.2	3.8	
Dominant Wavelength	λ_D	Y	--	590	--	nm
		PG	--	525	--	
Peak Emission Wavelength	λ_P	Y	--	592	--	nm
		PG	--	--	--	
Luminous Intensity Matching Ratio	Iv-m	Y	--	--	2:1	--
		PG	--	--	--	
Spectrum Radiation Bandwidth	$\Delta\lambda$	Y	--	20	--	nm
		PG	--	--	--	
Reverse Current	IR	--	--	100	μ A	VR = 5V



American Opto Plus LED Corp. CTD-IC591YPG-WW

15.0 x 15.0 x 11.0 mm Bi-Color Touch LED Display w/ Touch Drive IC

LUMINOUS GENERAL Iv BIN GRADE (YELLOW)

(If = 20mA)

A	B	C	D	E	F	G	H	J	K	L	M
0.155	0.249	0.399	0.640	1.025	1.641	2.627	4.204	6.727	10.764	17.224	27.559
}	}	}	}	}	}	}	}	}	}	}	}
0.248	0.398	0.639	1.024	1.640	2.626	4.203	6.726	10.763	17.223	27.558	44.095
N	P	Q	R	S	T	U	V	W	X	Y	1
44.096	70.555	112.889	180.622	288.997	462.397	739.836	1183.738	1893.982	3030.372	4848.597	7757.756
}	}	}	}	}	}	}	}	}	}	}	}
70.554	112.888	180.622	288.996	462.396	739.835	1183.737	1893.981	3030.371	4848.596	7757.755	12412.409
2	3	4	5	6	7	8	9				
4034.034	19859.858	31775.773	50841.238	81345.982	130153.573	208245.718	333193.149				
}	}	}	}	}	}	}	}	}	}	}	}
19859.857	31775.772	50841.237	81345.981	130153.572	208245.717	333193.148	533109.039				

LUMINOUS GENERAL Iv BIN GRADE (PRUE GREEN)

(If = 20mA)

A	B	C	D	E	F	G	H	J	K	L	M
0.155	0.249	0.399	0.640	1.025	1.641	2.627	4.204	6.727	10.764	17.224	27.559
}	}	}	}	}	}	}	}	}	}	}	}
0.248	0.398	0.639	1.024	1.640	2.626	4.203	6.726	10.763	17.223	27.558	44.095
N	P	Q	R	S	T	U	V	W	X	Y	1
44.096	70.555	112.889	180.622	288.997	462.397	739.836	1183.738	1893.982	3030.372	4848.597	7757.756
}	}	}	}	}	}	}	}	}	}	}	}
70.554	112.888	180.622	288.996	462.396	739.835	1183.737	1893.981	3030.371	4848.596	7757.755	12412.409
2	3	4	5	6	7	8	9				
4034.034	19859.858	31775.773	50841.238	81345.982	130153.573	208245.718	333193.149				
}	}	}	}	}	}	}	}	}	}	}	}
19859.857	31775.772	50841.237	81345.981	130153.572	208245.717	333193.148	533109.039				

1. Unit = mcd.
2. Tolerance: ±20%.

COLOR RANK LIMITS (YELLOW)

(If = 20mA)

1	2	3	4	5
583.0	585.0	587.0	589.0	591.0
585.0	587.0	589.0	591.0	593.0

COLOR RANK LIMITS (YELLOW)

(If = 20mA)

0	1	2	3	4
522.0	524.0	526.0	528.0	530.0
}	}	}	}	}
523.9	525.9	527.9	529.9	532.0

1. Unit = nm.
2. Tolerance: ±1.

ELECTRICAL/OPTICAL CHARACTERISTICS CURVES (YELLOW)

(Ta=25°C)

Version 1.1 Date: 04-22-2020 Specifications are subject to change without notice.

American Opto Plus LED Corp. 1206 E. Lexington Ave., Pomona CA 91766 Tel: 909-465-0080 Fax: 909-465-0130 www.aopled.com



American Opto Plus LED Corp.

CTD-IC591YPG-WW

15.0 x 15.0 x 11.0 mm Bi-Color Touch LED Display w/ Touch Drive IC

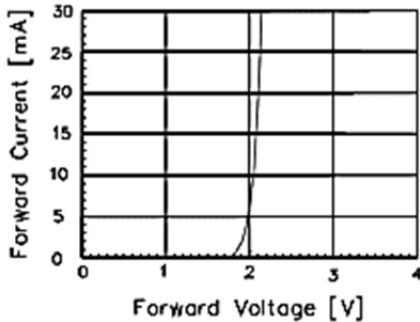

Fig 1. Forward Current vs. Forward Voltage

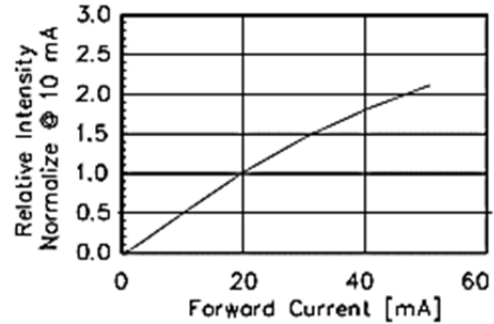

Fig 2. Relative Intensity vs. Forward Current

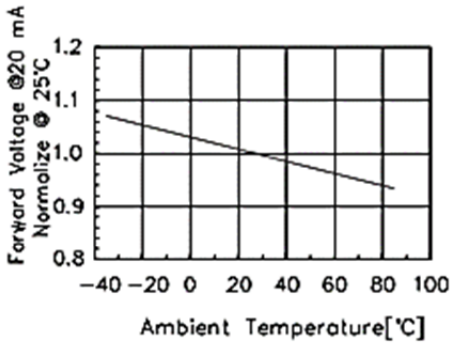

Fig 3. Forward Voltage vs. Temperature

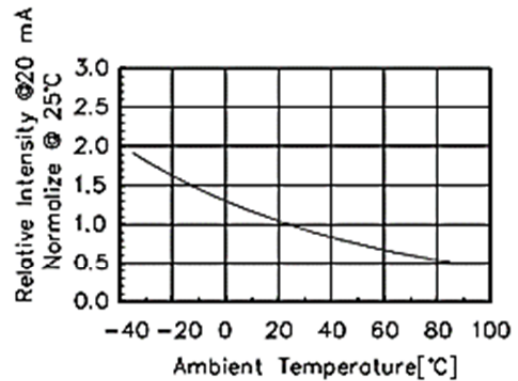

Fig 4. Relative Intensity vs. Temperature

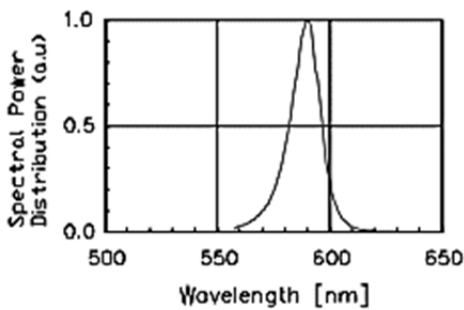

Fig 5. Spectral Power Distribution vs. Wavelength

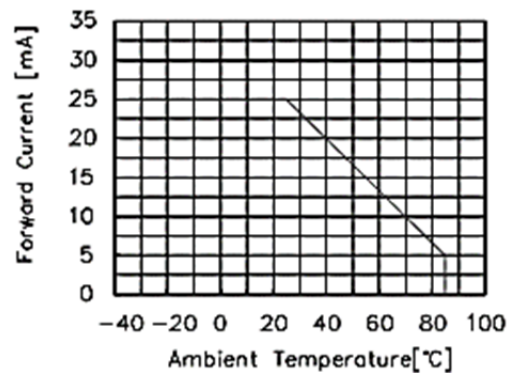

Fig 6. Forward current vs. Temperature



American Opto Plus LED Corp.

CTD-IC591YPG-WW

15.0 x 15.0 x 11.0 mm Bi-Color Touch LED Display w/ Touch Drive IC

ELECTRICAL/OPTICAL CHARACTERISTICS CURVES (PRUE GREEN)

(Ta=25°C)

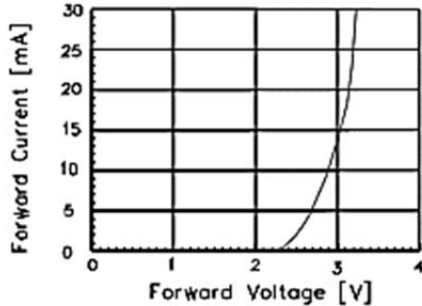

Fig 1. Forward Current vs. Forward Voltage

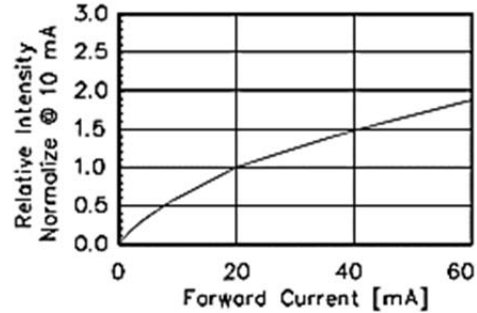

Fig 2. Relative Intensity vs. Forward Current

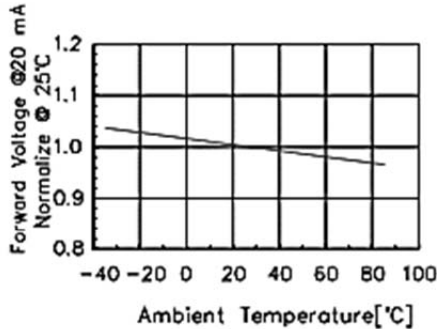

Fig 3. Forward Voltage vs. Temperature

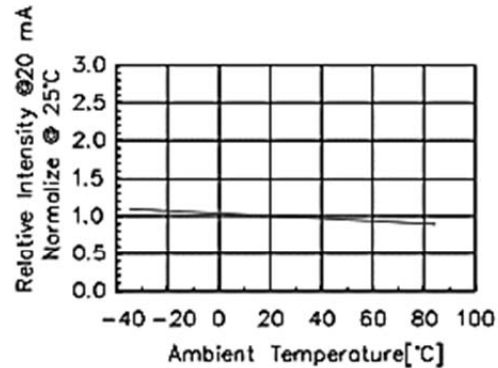

Fig 4. Relative Intensity vs. Temperature

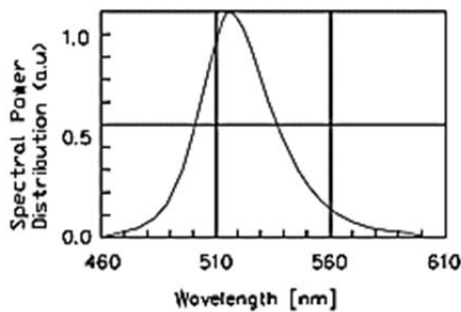

Fig 5. Spectral Power Distribution vs. Wavelength

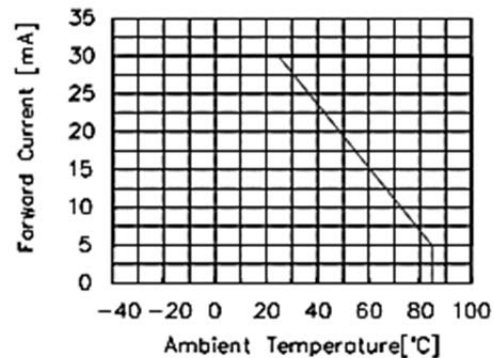

Fig 6. Forward current vs. Temperature



American Opto Plus LED Corp. CTD-IC591YPG-WW

15.0 x 15.0 x 11.0 mm Bi-Color Touch LED Display w/ Touch Drive IC

SOLDERING CONDITIONS

1. Wave Soldering Profile

Distance: 1.6mm min (From Seating Plane)

Item	Condition		Note
Preheat	Temperature T1	80 – 120 °C	PWB Temperature (Soldering Side Surface)
	Time t1	60 – 180sec	
Solder Dip	Temperature T2	230 – 260°C	Bath Temperature
	Time t2	2 – 4 sec	Solder Tank Passage Time

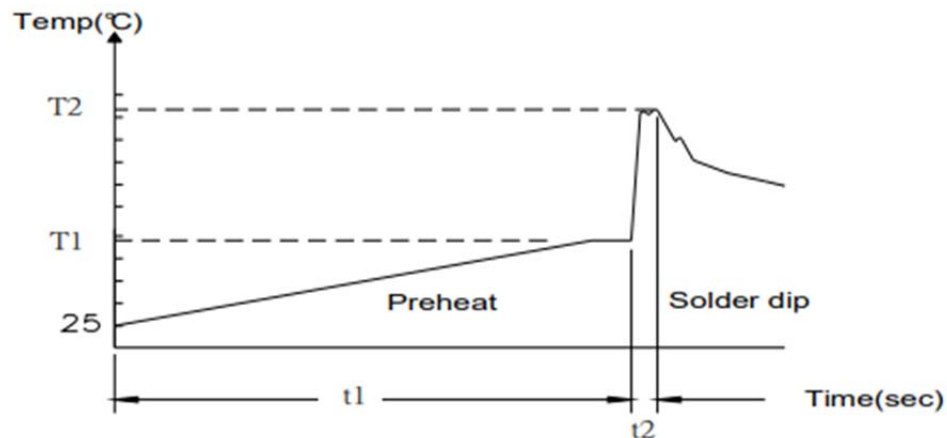

2. Hand Soldering (Iron Condition)

Soldering Iron: 30W Max

Temperature 350°C Max

Soldering Time: 3 Seconds Max (One Time)

Distance: 1.6mm min (From Seating Plane)



American Opto Plus LED Corp.

CTD-IC591YPG-WW

15.0 x 15.0 x 11.0 mm Bi-Color Touch LED Display w/ Touch Drive IC

PACKAGE SPECIFICATION

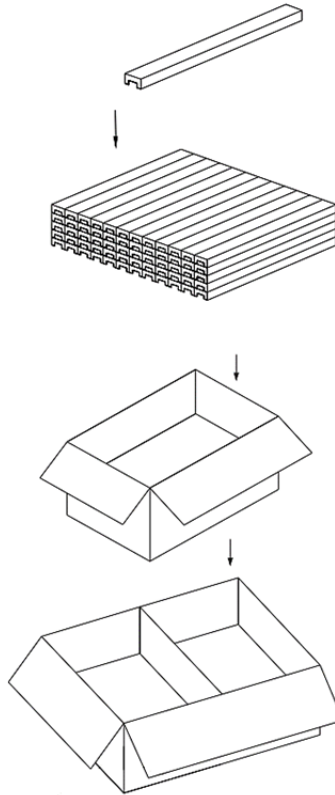

Package	Size	Unit	Amount	Unit	Amount	Unit	Note
TUBE	L300*W190*H20	mm	1	TUBE	10	Pcs	--
Inner Box	L305*W205*H240	mm	187	TUBE	1870	Pcs	17*11=187
Outer Box	L430*W330*H270	mm	2	Inner Box	3740	Pcs	--

STORAGE METHOD

1. Product cannot be placed on the location of direct sunlight.
2. Product storage environment: Temp. -35°C~85°C, RH 45%~85%.
3. After unpacking the product be use within 1 year.
4. After unpacking, do not take anything up in order to avoid PIN shifting.