

MATERIALS AND FINISHES

BODY, CRIMP TUBE, C'NUT BRASS
PLATED SEE TABLE

CENTER CONTACT BRASS
PLATED GOLD

INSULATOR, SPACER TEFLON

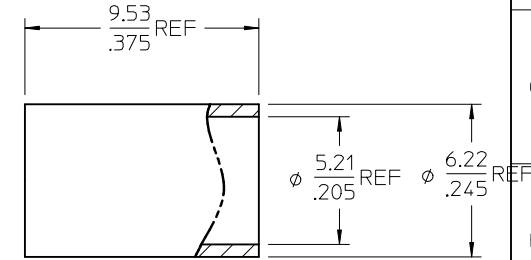
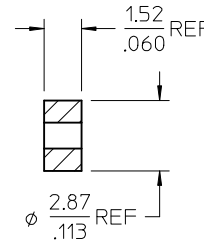
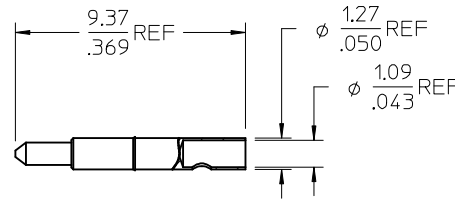
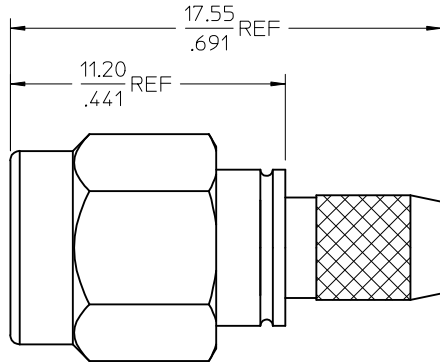
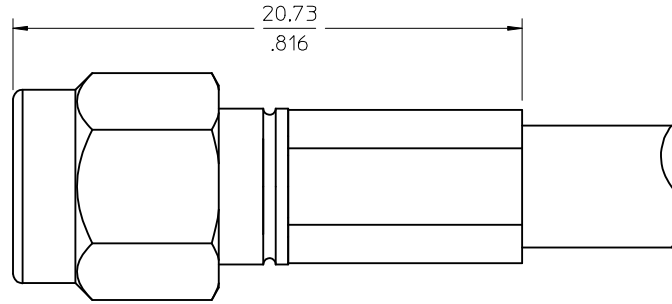
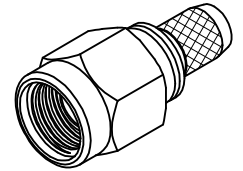

CONTACT

SPACER

CRIMP TUBE

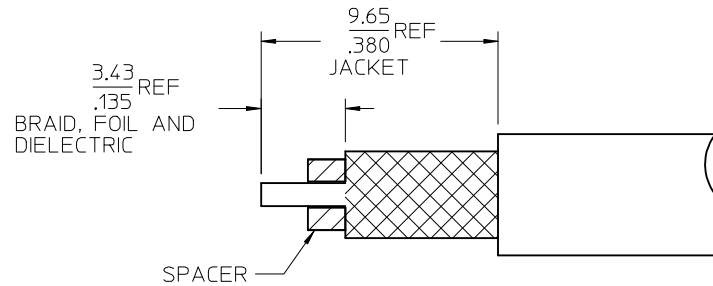

RECOMMENDED STRIPPING DIMENSIONS
CRIMP HEX SIZE 5.41(.213)

73251-1631	GOLD
73251-1630	NICKEL
PART NO.	PLATING

MIL-STD-348A, FIG. 310.1	INTERFACE
SPECIFICATION	DESCRIPTION

CHG: STRIP DIM WAS
1.91 REF DIELECTRIC,
2.16 REF FOIL AND
3.43 BRAID. ADDED
SPACER. REMOVED
AS-89678-770
EC NO: URF-2008-0052
DRW:SSSHAH 2007/07/27
CHKD:FLAHERY 2007/07/27
APPR:JWENER 2007/07/27

QUALITY SYMBOLS

 DESCRIPTION
 REV: A3

GENERAL TOLERANCES (UNLESS SPECIFIED)

	mm	INCH
4 PLACES	± .005	± .0005
3 PLACES	± .003	± .0003
2 PLACES	± .002	± .0002
1 PLACE	± .001	± .0001

ANGULAR ± 2°

DRAFT WHERE APPLICABLE
MUST REMAIN
WITHIN DIMENSIONS

DIMENSION STYLE
MM/IN

DRAWN BY SSS DATE 2001/08/02
 CHECKED BY TEF DATE 2001/08/02
 APPROVED BY GMH DATE 2001/08/02

MATERIAL NO. SEE TABLE
 SIZE C

SCALE DESIGN UNITS METRIC
 THIRD ANGLE PROJECTION

TITLE
**SMA PLUG, STR
 50 OHMS, BELDEN 7806R
 SMA-PC**

MOLEX INCORPORATED
 DOCUMENT NO. SD-73251-163
 SHEET NO. 1 OF 1

THIS DRAWING CONTAINS INFORMATION THAT IS PROPRIETARY TO MOLEX INCORPORATED AND SHOULD NOT BE USED WITHOUT WRITTEN PERMISSION

MATERIALS AND FINISHES

BODY, CRIMP TUBE, C'NUT BRASS
PLATED SEE TABLE

CENTER CONTACT BRASS
PLATED GOLD

INSULATOR, SPACER TEFLON

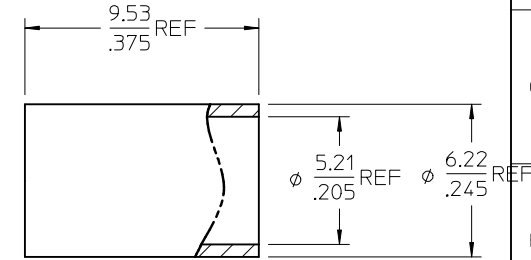
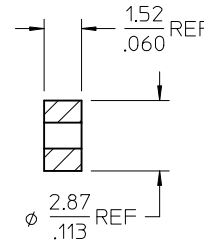
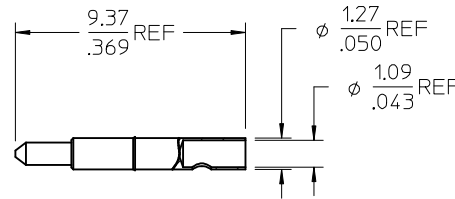
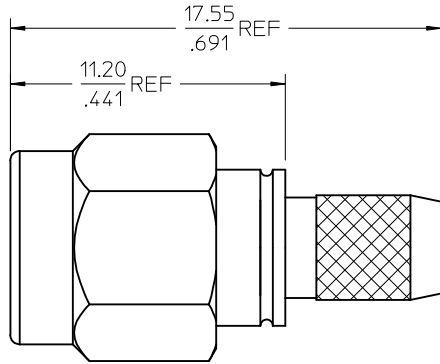
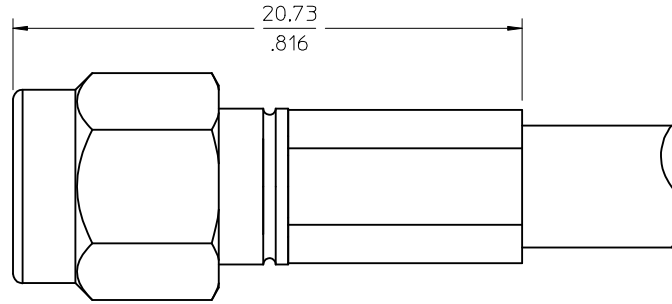
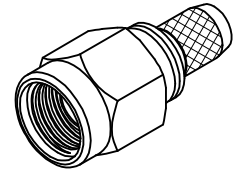

CONTACT

SPACER

CRIMP TUBE

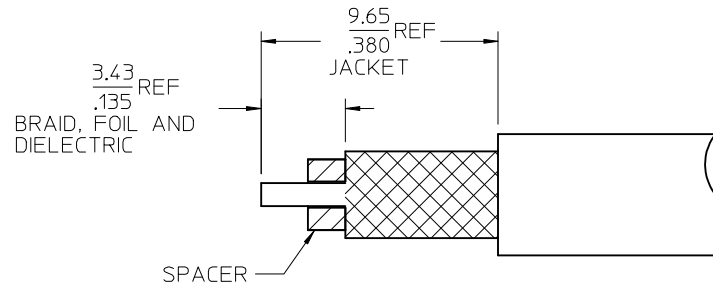

RECOMMENDED STRIPPING DIMENSIONS
CRIMP HEX SIZE 5.41(.213)

73251-1631	GOLD
73251-1630	NICKEL
PART NO.	PLATING

MIL-STD-348A, FIG. 310.1	INTERFACE
SPECIFICATION	DESCRIPTION

CHG: STRIP DIM WAS
1.91 REF DIELECTRIC,
2.16 REF FOIL AND
3.43 BRAID. ADDED
SPACER. REMOVED
AS-89678-770
EC NO: URF-2008-0052
DRW:SSSHAH 2007/07/27
CHKD:FLAHERY 2007/07/27
APPR:JWENER 2007/07/27

QUALITY SYMBOLS

 DESCRIPTION
 REV: A3

GENERAL TOLERANCES (UNLESS SPECIFIED)

	mm	INCH
4 PLACES	± .005	± .0005
3 PLACES	± .005	± .0005
2 PLACES	± .005	± .0005
1 PLACE	± .005	± .0005

ANGULAR ± 2 °

DRAFT WHERE APPLICABLE
MUST REMAIN
WITHIN DIMENSIONS

DIMENSION STYLE
MM/IN

DRAWN BY SSS DATE 2001/08/02
 CHECKED BY TEF DATE 2001/08/02
 APPROVED BY GMH DATE 2001/08/02

MATERIAL NO. SEE TABLE
 SIZE C

SCALE DESIGN UNITS METRIC
 THIRD ANGLE PROJECTION

TITLE
**SMA PLUG, STR
 50 OHMS, BELDEN 7806R
 SMA-PC**

MOLEX INCORPORATED
 DOCUMENT NO. SD-73251-163
 SHEET NO. 1 OF 1

THIS DRAWING CONTAINS INFORMATION THAT IS PROPRIETARY TO MOLEX
 INCORPORATED AND SHOULD NOT BE USED WITHOUT WRITTEN PERMISSION