

THIS IS A C.A.D. GENERATED DRAWING
DO NOT MAKE MANUAL REVISIONS TO MASTER.

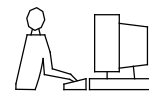

TOLERANCE UNLESS OTHERWISE SPECIFIED	
.X	±0.15
.XX	±0.10
.XXX	±0.05

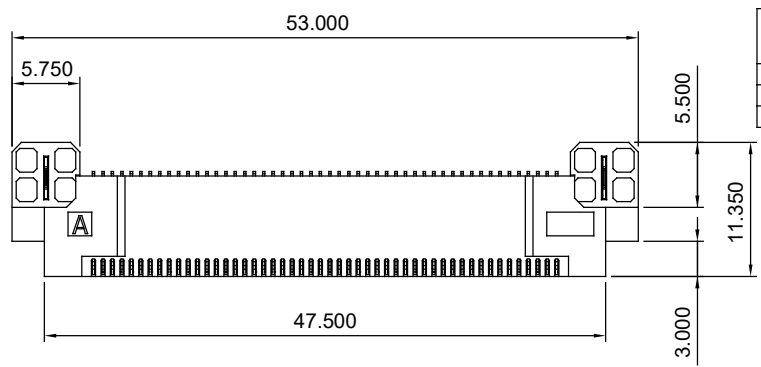

NOTES:

MATERIAL: L.C.P SERIES, UL-94V-0
HOUSING: COPPER ALLOY
CONTACT: GOLD FLASH PLATING ON CONTACT AREA
MATTE TIN PLATING ON SOLDER TAIL OVER NICKEL UNDER PLATING

MARKED : CRITICAL DIMENSION
MARKED : DIMENSIONS NEED TO BE MEASURED IN CPK

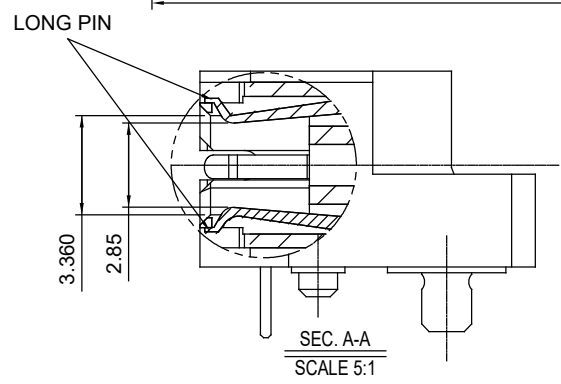
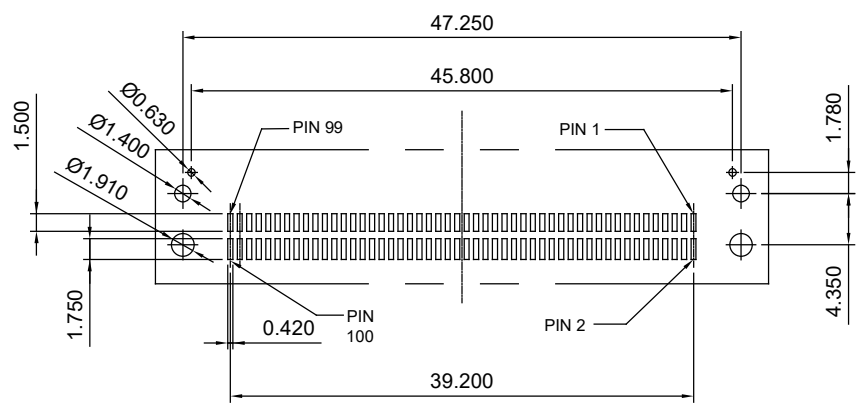
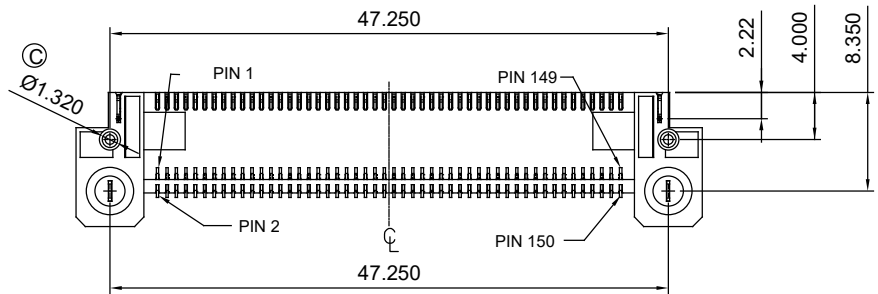
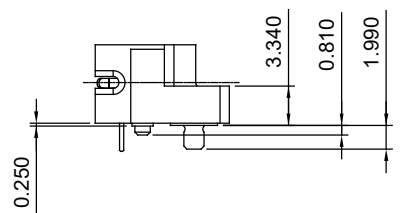
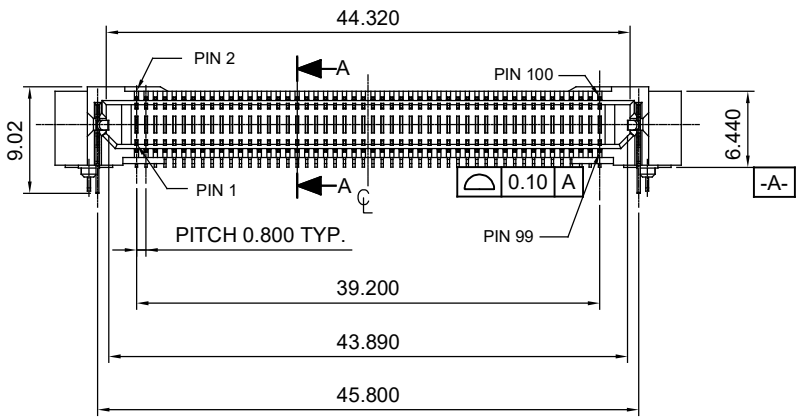

SEC. A-A
SCALE 5:1

**BOARD TO BOARD, 100 CONTACTS RIGHT ANGLE,
ALL LONG PIN, FEMALE**

ACAD REFERENCE NO.: 473-100-571-002	
DRAWN: W.T	DATE: JUNE.28 /2018
CHECKED:	DATE:
SCALE: N.T.S	SHEET 1 OF 1
DRAWING NUMBER: 473-100-571-002	ISSUE
PART NUMBER: 473-100-571-002	1



THIS SERIES FULLY CONFORMS TO THE EUROPEAN UNION DIRECTIVES 2011/65/EU FOR RoHS COMPLIANCE.



EDAC INC
TORONTO, ONTARIO
CANADA
YOUR CONNECTION TO QUALITY & SERVICE

THESE DRAWINGS AND SPECIFICATIONS ARE THE PROPERTY OF EDAC INC., AND SHALL NOT BE REPRODUCED, OR COPIED OR USED AS THE BASIS FOR THE MANUFACTURE OR SALE OF APPARATUS WITHOUT WRITTEN PERMISSION.