

## Overview

The KEMET SCN-XV coils are dual mode chokes with a wide variety of characteristics for automotive and industrial application, especially suitable for harsh environment situations. These hybrid coils combine the two functions of normal mode countermeasure and common mode noise suppression in just one coil. Reducing the number of required products ensures cost savings and space efficiency. Our proprietary ferrite core material 7HT provides optimized solutions for high-temperature requirements, and in addition displays high Bs characteristics, and are useful in various noise countermeasure fields.

## Applications

- On board charger for EV/PHEV
- Wireless charging systems with 85 kHz
- Medium power drives for steering, air conditioning and mild hybrid 48 V systems
- High voltage automotive and harsh environment industrial EMI filtering

## Benefits

- Proprietary 7HT ferrite material
- High rated voltage up to 1,000 V AC/DC
- Operating temperature range from -40°C up to +150°C
- High permeability
- High impedance
- UL 94 V-0 flame retardant rated base and cap
- AEC-Q200 qualified

SCN35XV Type



SCN35SXV Type



## Part Number System

SCN	35XV-	100-	1R4	A	015	JH
Series	Dimension Code (See Dimensions)	Rated Current (A)	Wire Diameter (mm)	Windings	Number of Turns	Terminal Base Type
SCN	35XV 35SXV	xxx- = xx.x A  Examples: 100 = 10.0 A 190 = 19.0 A	R = Decimal point  Examples: 1R4 = 1.4 mm 1R9 = 1.9 mm	A = Single	00x = x turns 0xx = xx turns  Examples: 008 = 8 turns 015 = 15 turns	JH = Horizontal type

## Dimensions – Millimeters

Figure 1

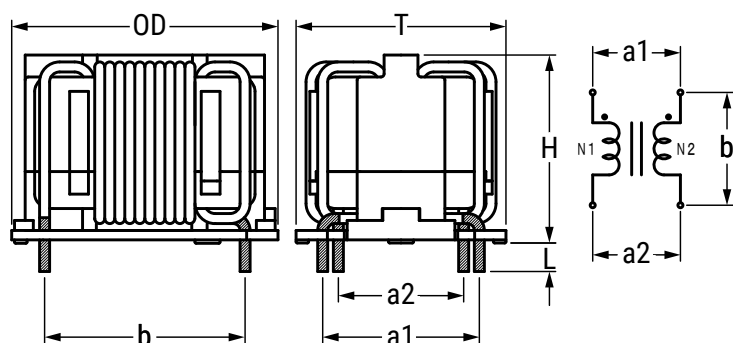

Part Name	Dimensions (mm)				Pin Pitch <sup>1</sup> (Reference)			Figure
	OD (Maximum)	T (Maximum)	H (Maximum)	L	a1	a2	b	
SCN35XV	43.5	34.5	32.0	3.50 ±0.5	25.0	20.0	32.0	Fig. 1
SCN35SXV	43.5	34.5	22.5	3.50 ±0.5	25.0	20.0	32.0	Fig. 1

<sup>1</sup> Pin pitch listed above for reference only. Values not guaranteed.

## Magnetic Permeability of Ferrite Material

In order to achieve most efficient noise reduction, it is important to select the material according to the target frequency band. Depending on its magnetic permeability, a particular ferrite material will be effective in a certain frequency band. A schematic representation of the relationship between the magnetic permeability of each material and the corresponding effective band range is shown in Figure 1.

Materials with higher magnetic permeability are effective in the lower frequency range, while those with lower magnetic permeability are effective in the higher frequency range. Thus, Mn-Zn products are mainly used for reducing conduction noise, while Ni-Zn products are commonly used for radiation noise countermeasures.

The effective frequency range varies depending on core shape, size and number of windings. This frequency dependence of the magnetic permeability as shown in the figure serves for reference purposes only and it should be tested on the actual device to determine its effectiveness.

S18H, S15H, 10H, 7H, 7HT, 5H, 5HT, 1400L and 700L are KEMET’s proprietary ferrite material names. Other materials can also be available on request.

Figure 1 - Relationship between the magnetic permeability of each material and its effective frequency range

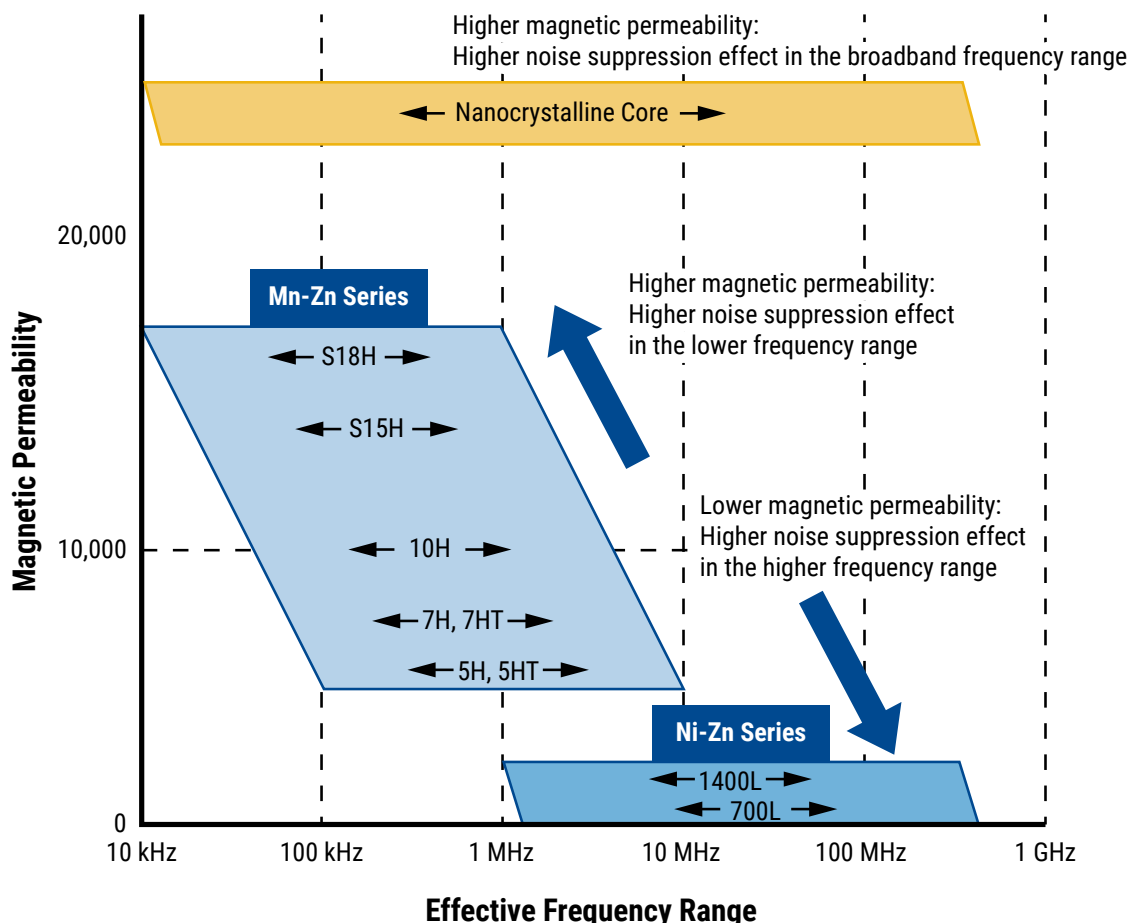

## Material List

### Core Structure for 2 Functions

- Both functions of common and differential mode in one package.
- High temperature resistant.
- Superior DC superimposing characteristics.
- Flat top surface for easy access to heat sink.

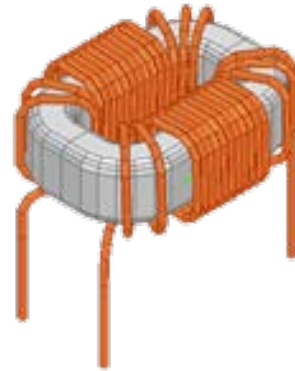

**Common Mode**

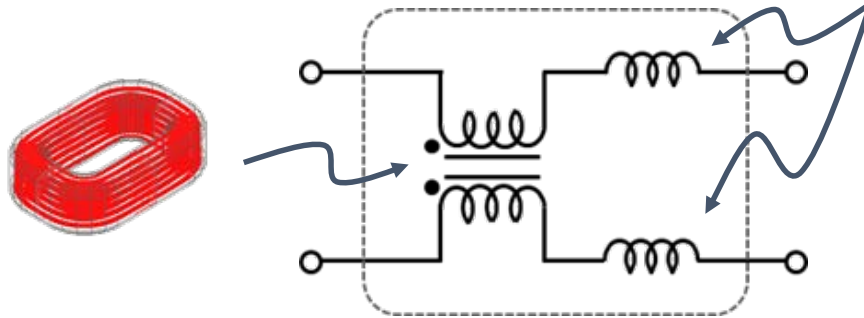

**Differential (Normal) Mode**

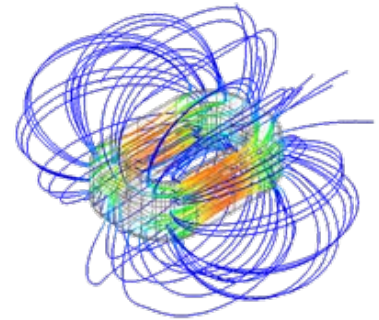

*Magnetic flux is under control based on electromagnetic simulation.*

## Environmental Compliance

All KEMET AC Line Filters are RoHS Compliant.



## Performance Characteristics

Item	Performance Characteristics
Rated Voltage	1,000 VAC/VDC
Withstanding Voltage	2,400 VAC (2 seconds, between lines)
Insulation Resistance	> 100 MΩ at 1,000 VDC (between lines)
Rated Current Range	10 – 19 A
Rated Inductance Range	0.38 – 2.7 mH ±30%
Inductance Measurement Condition	100 kHz
Operating Temperature Range	-40°C to +150°C (include self temperature rise)

**Table 1 – Ratings & Part Number Reference**

Part Number	Rated Voltage AC/DC (V)	Rated Current (A)	Inductance (Common) (mH) ±30%	Inductance (Normal) (μH) Typical	DC Resistance/Line (mΩ) ±13%	Temperature Rise (K) Maximum	Wire Diameter (mm)	Weight (g) Approximate
SCN35XV-100-1R4A015JH	1,000	10	2.70	13.9	11.10	55	1.4	81.9
SCN35XV-110-1R5A014JH	1,000	11	2.35	12.2	8.95	50	1.5	84.7
SCN35XV-120-1R6A012JH	1,000	12	1.73	9.8	6.85	50	1.6	83.8
SCN35XV-140-1R7A010JH	1,000	14	1.20	7.5	5.05	55	1.7	82.4
SCN35XV-170-1R9A008JH	1,000	17	0.77	4.8	3.25	55	1.9	82.8
SCN35SXV-110-1R4A015JH	1,000	11	1.35	11.1	7.78	60	1.4	49.6
SCN35SXV-120-1R5A014JH	1,000	12	1.18	9.5	6.36	55	1.5	51.1
SCN35SXV-130-1R6A012JH	1,000	13	0.86	7.6	4.85	50	1.6	50.5
SCN35SXV-150-1R7A010JH	1,000	15	0.60	5.8	3.52	55	1.7	49.6
SCN35SXV-190-1R9A008JH	1,000	19	0.38	3.7	2.36	55	1.9	50.0

## Frequency Characteristics

SCN35XV-100-1R4A015JH

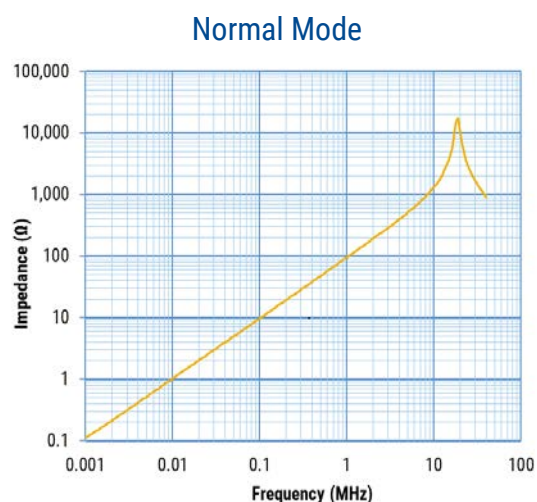
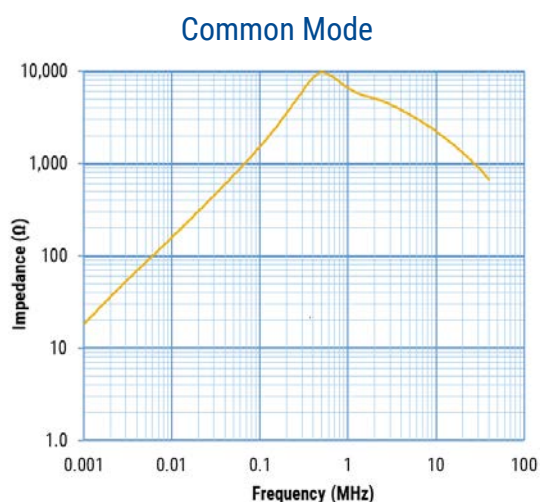

## Frequency Characteristics cont.

SCN35XV-110-1R5A014JH

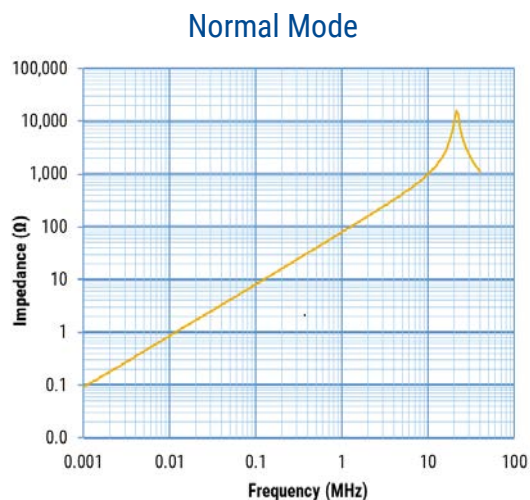
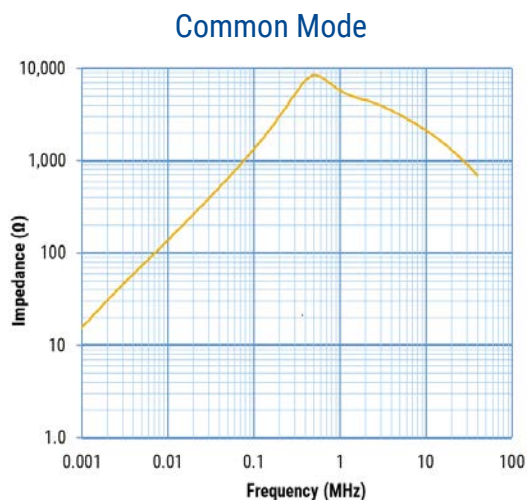

SCN35XV-120-1R6A012JH

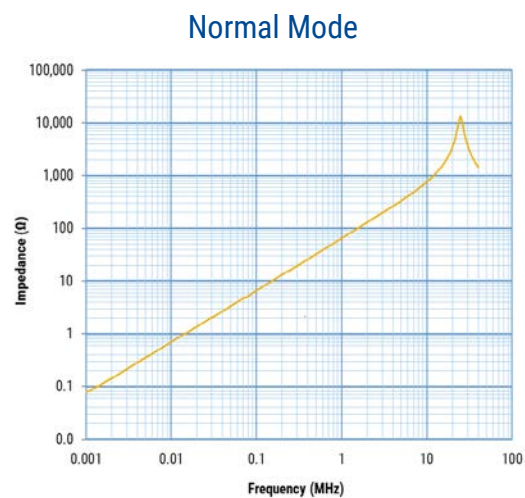
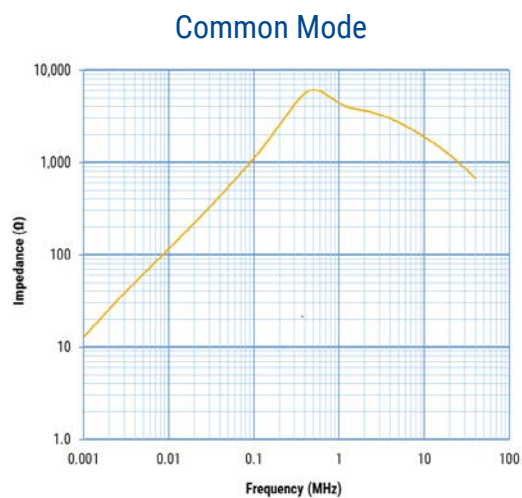

## Frequency Characteristics cont.

SCN35XV-140-1R7A010JH

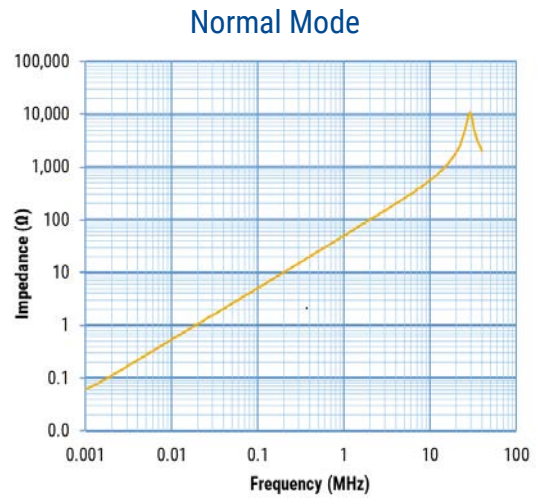
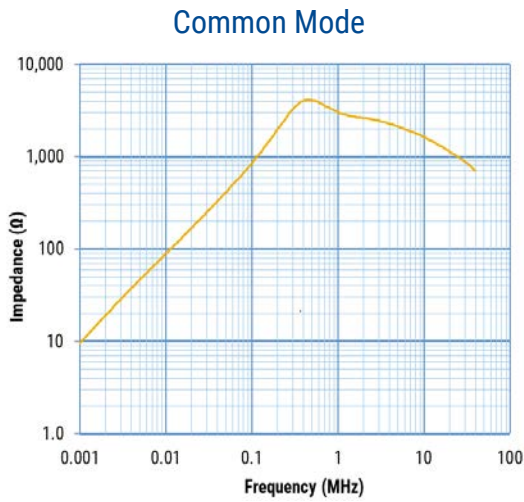

SCN35XV-170-1R9A008JH

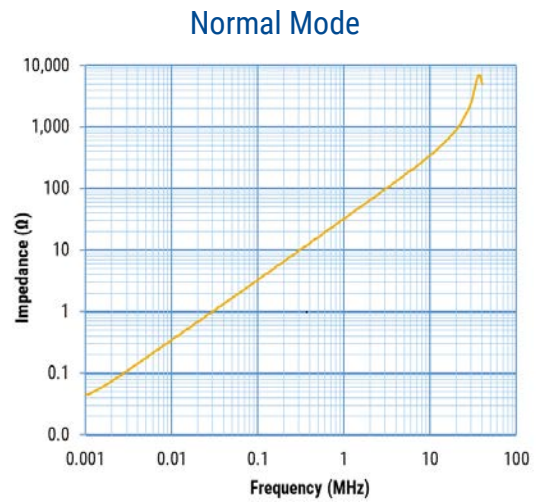
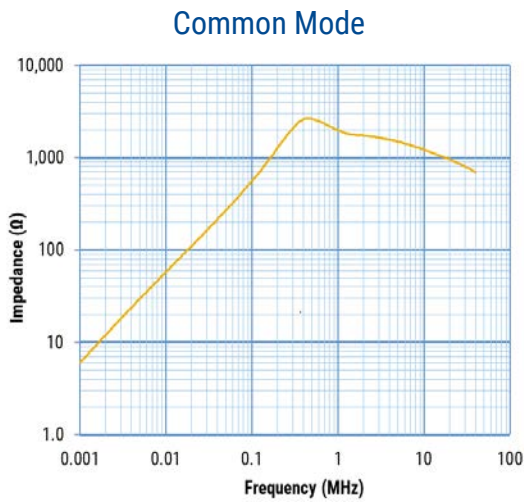

## Frequency Characteristics cont.

SCN35SXV-110-1R4A015JH

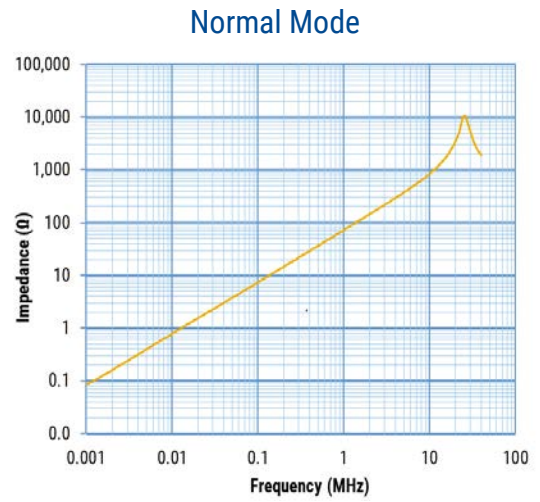
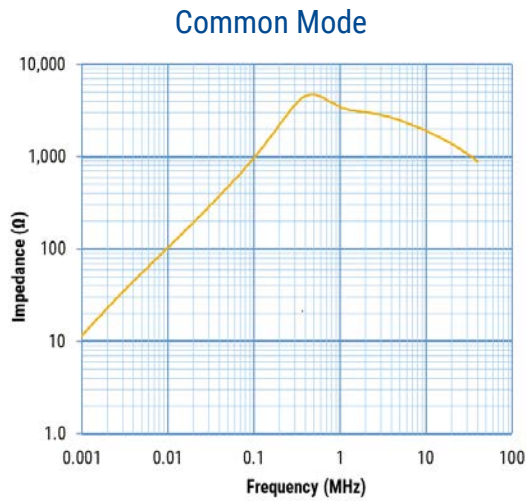

SCN35SXV-120-1R5A014JH

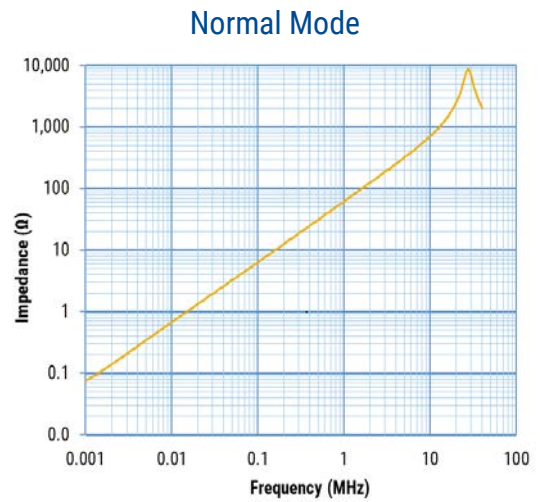
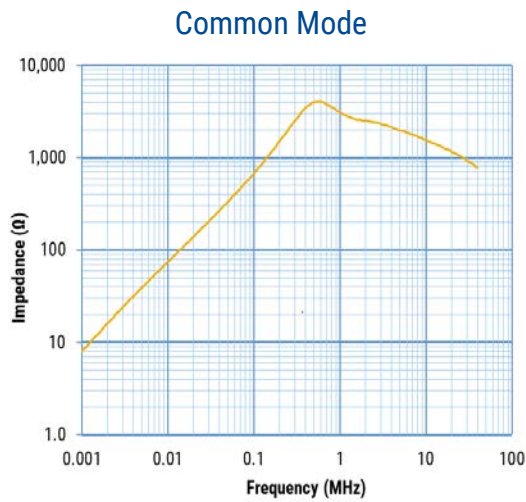



## Frequency Characteristics cont.

SCN35SXV-130-1R6A012JH

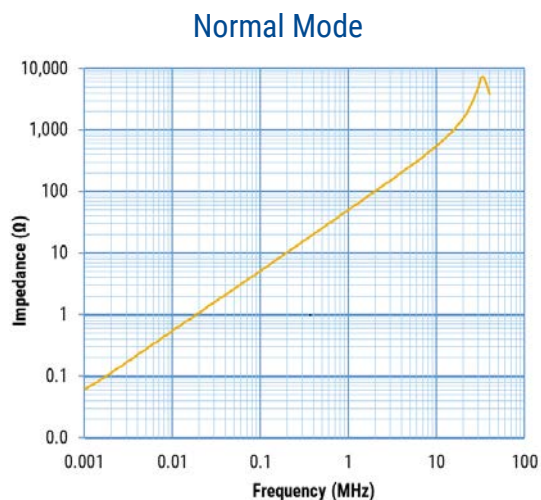
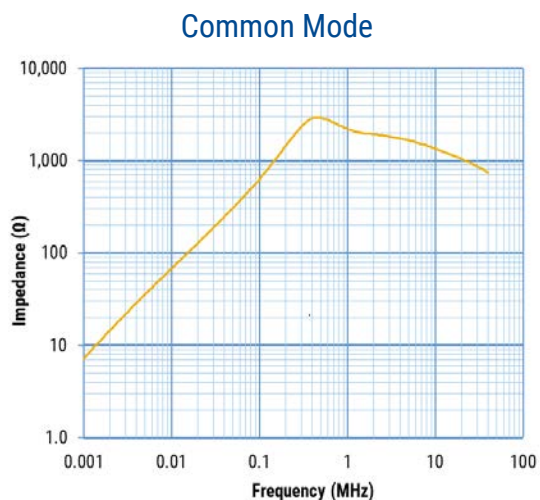

SCN35SXV-150-1R7A010JH

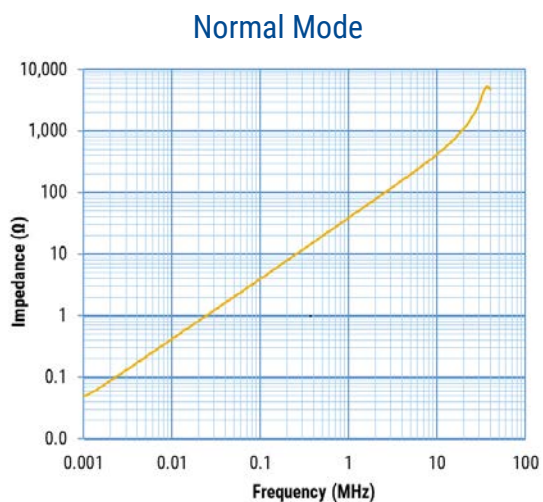
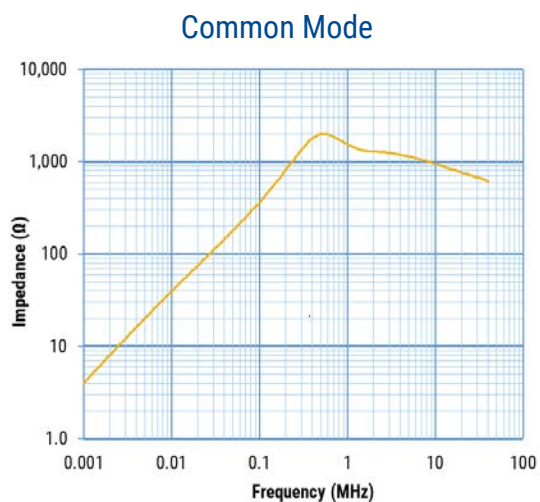

## Frequency Characteristics cont.

SCN35SXV-190-1R9A008JH

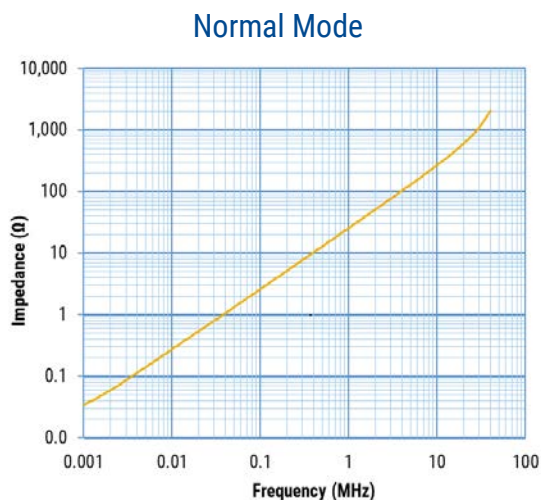
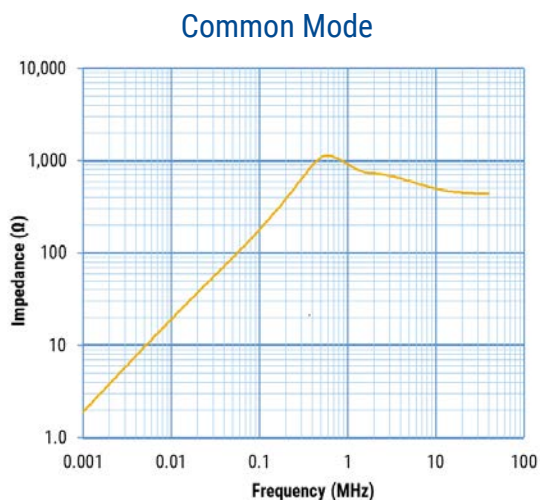

## Packaging

Type	Packaging Type	Pieces Per Box
SCN35XV	Tray	80
SCN35SXV		100

## Handling Precautions

### Precautions for product storage

AC Line Filters should be stored in normal working environments. While the chokes themselves are quite robust in other environments, solderability will be degraded by exposure to high temperatures, high humidity, corrosive atmospheres, and long term storage.

KEMET recommends that maximum storage temperature not exceed 40°C and maximum storage humidity not exceed 70% relative humidity. Atmospheres should be free of chlorine and sulfur bearing compounds. Temperature fluctuations should be minimized to avoid condensation on the parts. Avoid storage near strong magnetic fields, as this might magnetize the product.

For optimized solderability, AC line filters stock should be used promptly and preferably within 6 months of receipt.

### Product temperature rise values

The values listed for temperature rise are the result of self-heating in wires when the rated current (commercial frequency) is applied.

When using the product, check and evaluate the value of the core temperature rise under actual operating conditions.

## KEMET Electronics Corporation Sales Offices

For a complete list of our global sales offices, please visit [www.kemet.com/sales](http://www.kemet.com/sales).

---

### Disclaimer

All product specifications, statements, information and data (collectively, the "Information") in this datasheet are subject to change. The customer is responsible for checking and verifying the extent to which the Information contained in this publication is applicable to an order at the time the order is placed. All Information given herein is believed to be accurate and reliable, but it is presented without guarantee, warranty, or responsibility of any kind, expressed or implied.

Statements of suitability for certain applications are based on KEMET Electronics Corporation's ("KEMET") knowledge of typical operating conditions for such applications, but are not intended to constitute – and KEMET specifically disclaims – any warranty concerning suitability for a specific customer application or use. The Information is intended for use only by customers who have the requisite experience and capability to determine the correct products for their application. Any technical advice inferred from this Information or otherwise provided by KEMET with reference to the use of KEMET's products is given gratis, and KEMET assumes no obligation or liability for the advice given or results obtained.

Although KEMET designs and manufactures its products to the most stringent quality and safety standards, given the current state of the art, isolated component failures may still occur. Accordingly, customer applications which require a high degree of reliability or safety should employ suitable designs or other safeguards (such as installation of protective circuitry or redundancies) in order to ensure that the failure of an electrical component does not result in a risk of personal injury or property damage.

Although all product-related warnings, cautions and notes must be observed, the customer should not assume that all safety measures are indicated or that other measures may not be required.

When providing KEMET products and technologies contained herein to other countries, the customer must abide by the procedures and provisions stipulated in all applicable export laws and regulations, including without limitation the International Traffic in Arms Regulations (ITAR), the US Export Administration Regulations (EAR) and the Japan Foreign Exchange and Foreign Trade Act.

*KEMET is a registered trademark of KEMET Electronics Corporation.*