

Data sheet | Item number: 750-467

2-channel analog input; 0 ... 10 VDC; Single-ended

[www.wago.com/750-467](http://www.wago.com/750-467)

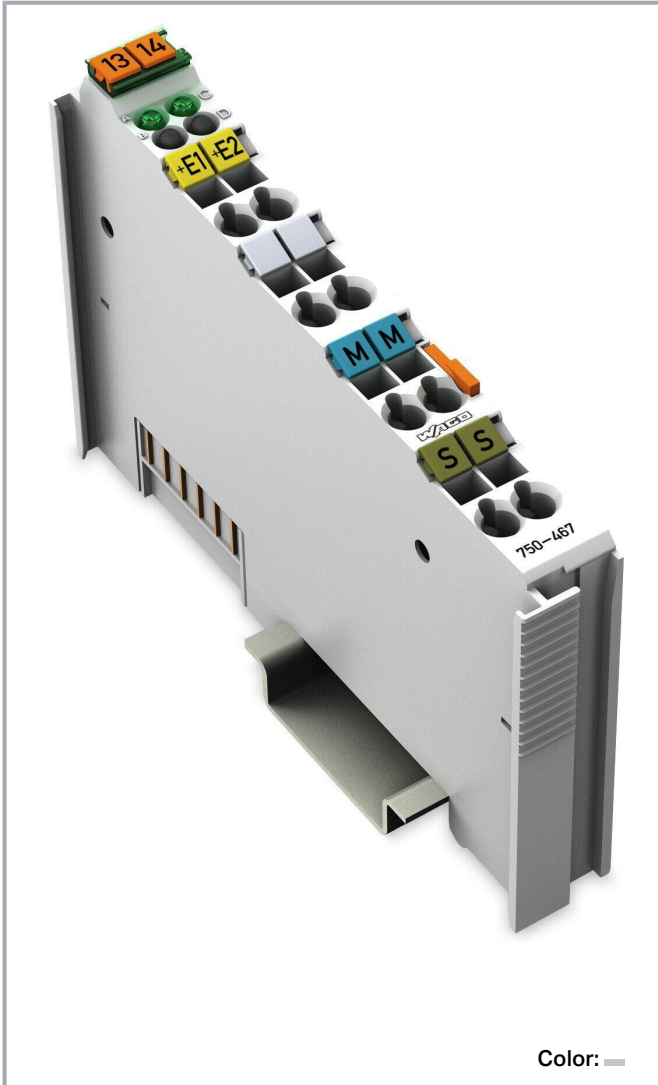

Color: —

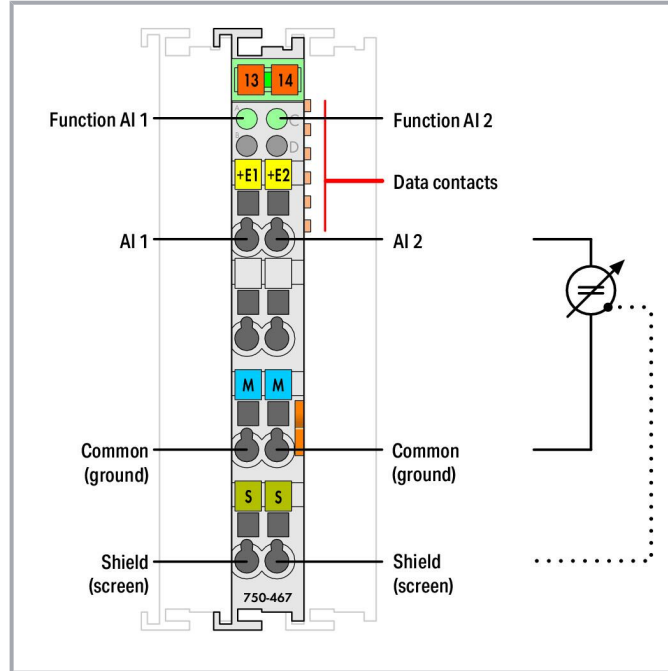

Subject to changes. Please also observe the further product documentation!

WAGO GmbH & Co. KG  
Hansastr. 27  
32423 Minden  
Phone: +49571 887-0 | Fax: +49571 887-169  
Email: [info.de@wago.com](mailto:info.de@wago.com) | Web: [www.wago.com](http://www.wago.com)

Do you have any questions about our products?  
We are always happy to take your call at +49 (571) 887-44222.

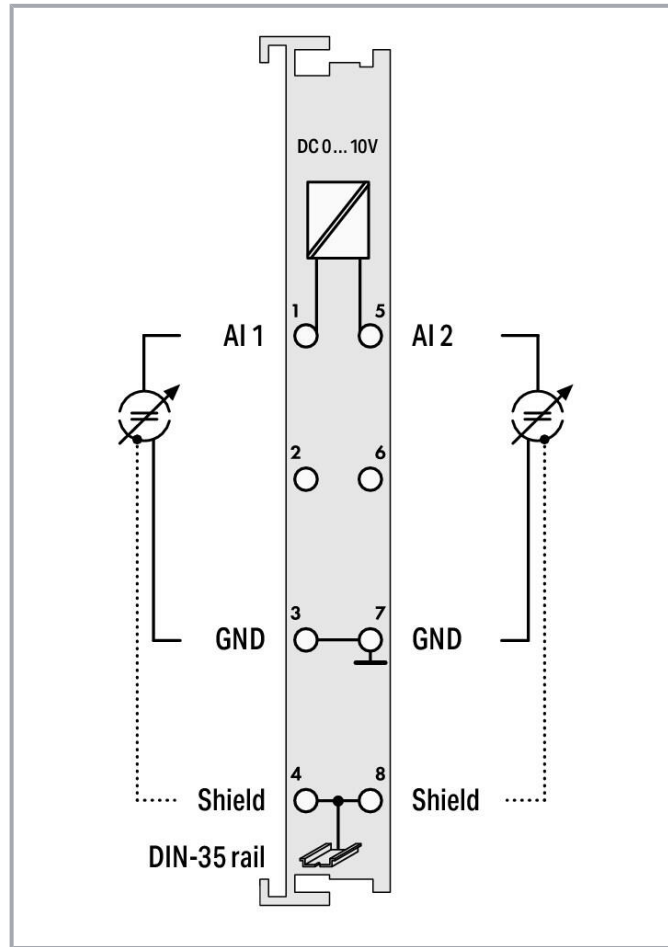
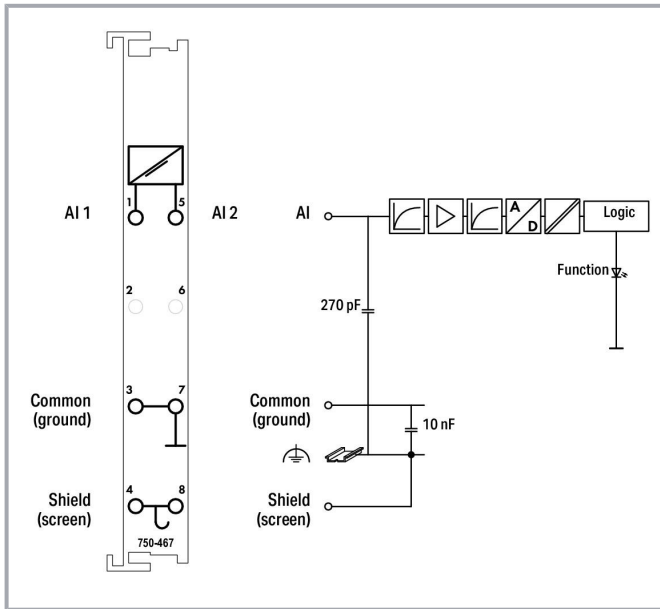

## Item description

This analog input module processes standard 0–10 V signals.

The input signal is electrically isolated and is transmitted with a resolution of 12 bits.

The internal system supply powers the module.

The input channels of the module have a common ground potential.

The shield directly connects to the DIN-rail.

## Data

### Technical data

Number of analog inputs	2
Total number of channels (module)	2

Subject to changes. Please also observe the further product documentation!



Signal type	Voltage
Signal type (voltage)	0 ... 10 VDC
Sensor connection	2 x (2-wire)
Input voltage (max.)	35 V
Signal characteristics	Single-ended
Resolution [bit]	12 bits
Data width	2 x 16-bit data; 2 x 8-bit control/status (optional)
Internal resistance	130 kΩ
Conversion time (typ.)	2 ms
Measurement error (reference temperature)	25 °C
Measurement error, deviation (max.) from the upper-range value	0.2 %
Temperature error (max.) of the upper-range value	0.01 %/K
Supply voltage (system)	5 VDC; via data contacts
Current consumption (5 V system supply)	60 mA
Isolation	500 V system/field
Indicators	LED (A, C) green: Function AI 1, AI 2

### Connection data

Connection technology: inputs/outputs	8 x CAGE CLAMP®
Connection type 1	Inputs/Outputs
Solid conductor	0.08 ... 2.5 mm <sup>2</sup> / 28 ... 14 AWG
Fine-stranded conductor	0.08 ... 2.5 mm <sup>2</sup> / 28 ... 14 AWG
Strip length	8 ... 9 mm / 0.31 ... 0.35 inches

### Physical data

Width	12 mm / 0.472 inches
Height	100 mm / 3.937 inches
Depth	69.8 mm / 2.748 inches
Depth from upper-edge of DIN-rail	62.6 mm / 2.465 inches

### Mechanical Data

Mounting type	DIN-35 rail
---------------	-------------

### Material Data

Color	light gray
Housing material	Polycarbonate; polyamide 6.6

Subject to changes. Please also observe the further product documentation!



Fire load	1.014 MJ
Weight	47.6 g
Conformity marking	CE

### Environmental requirements

Ambient temperature (operation)	0 ... +55 °C
Ambient temperature (storage)	-25 ... +85 °C
Protection type	IP20
Pollution degree	2 per IEC 61131-2
Operating altitude	0 ... 2000 m / 0 ... 6562 ft
Mounting position	horizontal (standing/lying); vertical
Relative humidity (without condensation)	95 %
Vibration resistance	per IEC 60068-2-6
Shock resistance	15g per IEC 60068-2-27
EMC immunity to interference	per EN 61000-6-2
EMC emission of interference	per EN 61000-6-4
Exposure to pollutants	Per IEC 60068-2-42 and IEC 60068-2-43
Permissible H <sub>2</sub> S contaminant concentration at a relative humidity 75 %	10 ppm
Permissible SO <sub>2</sub> contaminant concentration at a relative humidity 75 %	25 ppm

### Commercial data

Product Group	15 (I/O System)
eCl@ss 10.0	27-24-26-01
eCl@ss 9.0	27-24-26-01
ETIM 8.0	EC001596
ETIM 7.0	EC001596
PU (SPU)	1 pcs
Packaging type	box
Country of origin	DE
GTIN	4045454392994
Customs tariff number	85389099990

### Environmental Product Compliance

CAS-No.	7439-92-1
REACH Candidate List Substance	Lead





Subject to changes. Please also observe the further product documentation!



RoHS Compliance Status	Compliant,With Exemption
RoHS Exemption	6(c) 7(a) 7(c)-I 7(c)-II
SCIP notification number (Austria)	7daf7c58-b236-4e47-9b75-6d15ff655b93
SCIP notification number (Belgium)	f0b934af-d8c6-4c3a-b00d-c31ec437ff6a
SCIP notification number (Bulgaria)	8b9c2188-4d74-44c1-865c-612307cd25e2
SCIP notification number (Czech Republic)	9f780f42-565a-41dd-be95-afb8da4d44fd
SCIP notification number (Denmark)	1756c932-55b9-4e30-9b73-1d19fdb7c2bd
SCIP notification number (Finland)	82f550b8-d48d-4477-897b-8c9fd2cf2fcc
SCIP notification number (France)	dea70fdb-33b9-416d-8c1e-88e737e8690e
SCIP notification number (Germany)	787c35fc-c496-4354-9d28-b9aea662a11a
SCIP notification number (Hungary)	4c8befe0-9e01-46b6-8a6e-cf80f25f731a
SCIP notification number (Italy)	e3698ec4-a690-4767-a299-aa046343070e
SCIP notification number (Netherlands)	c31ba6ec-fcae-49de-bc97-5394159d4295
SCIP notification number (Poland)	11831b17-7a0d-43d0-8ef1-b9cc6e0bb45a
SCIP notification number (Romania)	8ce057ae-9f70-46f5-8327-f805024916cc
SCIP notification number (Sweden)	1ae5e9cf-a405-425c-8687-40f8ffa78648

## Approvals / Certificates

### General approvals

Logo	Approval	Additional Approval Text	Certificate name
	CCC CNEX	CNCA-C23-01	2020312310000213 (Ex ec IIC T4 Gc)
	EAC Brjansker Zertifizierungsstelle	TP TC 020/2011	EAC RU C-DE.AM02. B.00087/19
	KC National Radio Research Agency	Article 58-2, Clause 3	MSIP-REM-W43- AIM750
	UL Underwriters Laboratories Inc. (ORDINARY LOCATIONS)	UL 508	E175199 Sec.1

### Declarations of conformity and manufacturer's declarations

Logo	Approval	Additional Approval Text	Certificate name
------	----------	--------------------------	------------------

Subject to changes. Please also observe the further product documentation!

WAGO GmbH & Co. KG  
Hansastr. 27  
32423 Minden  
Phone: +49571 887-0 | Fax: +49571 887-169  
Email: [info.de@wago.com](mailto:info.de@wago.com) | Web: [www.wago.com](http://www.wago.com)

Do you have any questions about our products?  
We are always happy to take your call at +49 (571) 887-44222.



EU-Declaration of Conformity  
WAGO GmbH & Co. KG

### Approvals for hazardous areas











Logo	Approval	Additional Approval Text	Certificate name
	<b>ATEX</b> TUEV Nord Cert GmbH	EN 60079-0	TUEV_14_ATEX_148929_X (II 3 G Ex ec IIC T4 Gc)
	<b>CCC</b> CNEX	CNCA-C23-01	2020312310000213 (Ex ec IIC T4 Gc)
	<b>EAC</b> Brjansker Zertifizierungsstelle	TP TC 012/2011	EAC RU C-DE.AM02.B.00163 /19 (2Ex nA IIC T4 Gc X)
	<b>IECEX</b> TUEV Nord Cert GmbH	IEC 60079-0	IECEX TUN 14.0035 X (Ex ec IIC T4 Gc)
	<b>INMETRO</b> TÜV Rheinland do Brasil Ltda.	IEC 60079-0	BR-Ex_TÜV 12.1297 X
	<b>UKEx</b> WAGO GmbH & Co. KG	EN 60079-0	UKCA_WAGO22UKEX003X_ec
	<b>UL</b> Underwriters Laboratories Inc. (HAZARDOUS LOCATIONS)	UL 121201	E198726 Sec.1

### Optional accessories

#### Marking accessories

Marker carrier			
	<b>Item no.: 750-103</b> Group marker carrier		<a href="http://www.wago.com/750-103">www.wago.com/750-103</a>
Marker			

Subject to changes. Please also observe the further product documentation!

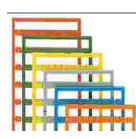
	<p><b>Item no.: 2009-145/000-006</b>                      Mini-WSB Inline; for Smart Printer; 1700 pieces on roll; stretchable 5 - 5.2 mm; plain; snap-on type; blue</p>	<p><a href="http://www.wago.com/2009-145/000-006">www.wago.com/2009-145/000-006</a></p>
	<p><b>Item no.: 2009-145</b>                      Mini-WSB Inline; for Smart Printer; 1700 pieces on roll; stretchable 5 - 5.2 mm; plain; snap-on type; white</p>	<p><a href="http://www.wago.com/2009-145">www.wago.com/2009-145</a></p>
	<p><b>Item no.: 2009-145/000-002</b>                      Mini-WSB Inline; for Smart Printer; 1700 pieces on roll; stretchable 5 - 5.2 mm; plain; snap-on type; yellow</p>	<p><a href="http://www.wago.com/2009-145/000-002">www.wago.com/2009-145/000-002</a></p>
	<p><b>Item no.: 2009-145/000-007</b>                      Mini-WSB Inline; for Smart Printer; 1700 pieces on roll; stretchable 5 - 5.2 mm; plain; snap-on type; gray</p>	<p><a href="http://www.wago.com/2009-145/000-007">www.wago.com/2009-145/000-007</a></p>
	<p><b>Item no.: 2009-145/000-005</b>                      Mini-WSB Inline; for Smart Printer; 1700 pieces on roll; stretchable 5 - 5.2 mm; plain; snap-on type; red</p>	<p><a href="http://www.wago.com/2009-145/000-005">www.wago.com/2009-145/000-005</a></p>
	<p><b>Item no.: 2009-145/000-012</b>                      Mini-WSB Inline; for Smart Printer; 1700 pieces on roll; stretchable 5 - 5.2 mm; plain; snap-on type; orange</p>	<p><a href="http://www.wago.com/2009-145/000-012">www.wago.com/2009-145/000-012</a></p>
	<p><b>Item no.: 2009-145/000-023</b>                      Mini-WSB Inline; for Smart Printer; 1700 pieces on roll; stretchable 5 - 5.2 mm; plain; snap-on type; green</p>	<p><a href="http://www.wago.com/2009-145/000-023">www.wago.com/2009-145/000-023</a></p>
	<p><b>Item no.: 2009-145/000-024</b>                      Mini-WSB Inline; for Smart Printer; 1700 pieces on roll; stretchable 5 - 5.2 mm; plain; snap-on type; violet</p>	<p><a href="http://www.wago.com/2009-145/000-024">www.wago.com/2009-145/000-024</a></p>
	<p><b>Item no.: 248-501/000-006</b>                      Mini-WSB marking card; as card; not stretchable; plain; snap-on type; blue</p>	<p><a href="http://www.wago.com/248-501/000-006">www.wago.com/248-501/000-006</a></p>
	<p><b>Item no.: 248-501/000-007</b>                      Mini-WSB marking card; as card; not stretchable; plain; snap-on type; gray</p>	<p><a href="http://www.wago.com/248-501/000-007">www.wago.com/248-501/000-007</a></p>
	<p><b>Item no.: 248-501/000-002</b>                      Mini-WSB marking card; as card; not stretchable; plain; snap-on type; yellow</p>	<p><a href="http://www.wago.com/248-501/000-002">www.wago.com/248-501/000-002</a></p>
	<p><b>Item no.: 248-501/000-012</b>                      Mini-WSB marking card; as card; not stretchable; plain; snap-on type; orange</p>	<p><a href="http://www.wago.com/248-501/000-012">www.wago.com/248-501/000-012</a></p>

Subject to changes. Please also observe the further product documentation!



**Item no.: 248-501**  
Mini-WSB marking card; as card; not stretchable; plain; snap-on type; white

[www.wago.com/248-501](http://www.wago.com/248-501)



**Item no.: 248-501/000-017**  
Mini-WSB marking card; as card; not stretchable; plain; snap-on type; light green

[www.wago.com/248-501/000-017](http://www.wago.com/248-501/000-017)



**Item no.: 248-501/000-005**  
Mini-WSB marking card; as card; not stretchable; plain; snap-on type; red

[www.wago.com/248-501/000-005](http://www.wago.com/248-501/000-005)



**Item no.: 248-501/000-024**  
Mini-WSB marking card; as card; not stretchable; plain; snap-on type; violet

[www.wago.com/248-501/000-024](http://www.wago.com/248-501/000-024)



**Item no.: 248-501/000-023**  
Mini-WSB marking card; as card; not stretchable; plain; snap-on type; green

[www.wago.com/248-501/000-023](http://www.wago.com/248-501/000-023)



**Item no.: 750-100**  
Marker card; as a DIN A4 sheet; plain

[www.wago.com/750-100](http://www.wago.com/750-100)

Group marker carrier



**Item no.: 750-106**  
Group marker carrier

[www.wago.com/750-106](http://www.wago.com/750-106)

System housing

System enclosure



**Item no.: 850-814/002-000**  
IP65 enclosure; Sheet steel (RAL 7035); WxHxD (200x120x200 mm); without flange plate

[www.wago.com/850-814/002-000](http://www.wago.com/850-814/002-000)



**Item no.: 850-815/002-000**  
IP65 enclosure; Sheet steel (RAL 7035); WxHxD (300x120x200 mm); without flange plate

[www.wago.com/850-815/002-000](http://www.wago.com/850-815/002-000)



**Item no.: 850-816/002-000**  
IP65 enclosure; Sheet steel (RAL 7035); WxHxD (400x120x200 mm); without flange plate

[www.wago.com/850-816/002-000](http://www.wago.com/850-816/002-000)



**Item no.: 850-817/002-000**  
IP65 enclosure; Sheet steel (RAL 7035); WxHxD (600x120x200 mm); without flange plate

[www.wago.com/850-817/002-000](http://www.wago.com/850-817/002-000)















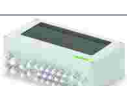

**Item no.: 850-825**  
IP65 enclosure; Aluminium (RAL 7032); WxHxD (160x100x160 mm); 9 x M12, 4 x M20

[www.wago.com/850-825](http://www.wago.com/850-825)

Subject to changes. Please also observe the further product documentation!



	<b>Item no.: 850-826</b> IP65 enclosure; Aluminium (RAL 7032); WxHxD (240x100x160 mm); 4 x M20, 4 x M16, 14 x M12 cable grip	<a href="http://www.wago.com/850-826">www.wago.com/850-826</a>
	<b>Item no.: 850-827</b> IP65 enclosure; Aluminium (RAL 7032); WxHxD (320x100x160 mm); 4 x M20, 8 x M16, 17 x M12 cable grip	<a href="http://www.wago.com/850-827">www.wago.com/850-827</a>
	<b>Item no.: 850-827/002-000</b> IP65 enclosure; Aluminium (RAL 7035); WxHxD (320x100x160 mm); 4 x M20, 8 x M16, 17 x M12 cable grip	<a href="http://www.wago.com/850-827/002-000">www.wago.com/850-827/002-000</a>
	<b>Item no.: 850-826/002-000</b> IP65 enclosure; Aluminium (RAL 7035); WxHxD (240x100x160 mm); 4 x M20, 4 x M16, 14 x M12 cable grip	<a href="http://www.wago.com/850-826/002-000">www.wago.com/850-826/002-000</a>
	<b>Item no.: 850-828/002-000</b> IP65 enclosure; Aluminium (RAL 7035); WxHxD (480x100x160 mm); 4 x M20, 10 x M16, 35 x M12 cable grip	<a href="http://www.wago.com/850-828/002-000">www.wago.com/850-828/002-000</a>
	<b>Item no.: 850-828</b> IP65 enclosure; Aluminium (RAL 7032); WxHxD (480x100x160 mm); 4 x M20, 10 x M16, 35 x M12 cable grip	<a href="http://www.wago.com/850-828">www.wago.com/850-828</a>
	<b>Item no.: 850-834</b> IP65 enclosure; Polyester (RAL 7032); WxHxD (164x100x164 mm); 9 x M12, 4 x M20	<a href="http://www.wago.com/850-834">www.wago.com/850-834</a>
	<b>Item no.: 850-835</b> IP65 enclosure; Polyester (RAL 7032); WxHxD (244x100x164 mm); 4 x M20, 4 x M16, 14 x M12 cable grip	<a href="http://www.wago.com/850-835">www.wago.com/850-835</a>
	<b>Item no.: 850-836</b> IP65 enclosure; Polyester (RAL 7032); WxHxD (324x100x164 mm); 4 x M20, 8 x M16, 17 x M12 cable grip	<a href="http://www.wago.com/850-836">www.wago.com/850-836</a>
<b>Carrier rail</b>		
Mounting accessories		
	<b>Item no.: 210-197</b> Steel carrier rail; 35 x 15 mm; 1.5 mm thick; 2 m long; slotted; similar to EN 60715; silver-colored	<a href="http://www.wago.com/210-197">www.wago.com/210-197</a>
	<b>Item no.: 210-198</b> Copper carrier rail; 35 x 15 mm; 2.3 mm thick; 2 m long; unslotted; according to EN 60715; copper-colored	<a href="http://www.wago.com/210-198">www.wago.com/210-198</a>
	<b>Item no.: 210-504</b> Steel carrier rail; 35 x 7.5 mm; 1 mm thick; 2 m long; slotted; galvanized; according to EN 60715; silver-colored	<a href="http://www.wago.com/210-504">www.wago.com/210-504</a>
	<b>Item no.: 210-505</b> Steel carrier rail; 35 x 7.5 mm; 1 mm thick; 2 m long; unslotted; galvanized; according to EN 60715; silver-colored	<a href="http://www.wago.com/210-505">www.wago.com/210-505</a>
	<b>Item no.: 210-506</b> Steel carrier rail; 35 x 15 mm; 1.5 mm thick; 2 m long; unslotted; galvanized; similar to EN 60715; silver-colored	<a href="http://www.wago.com/210-506">www.wago.com/210-506</a>

Subject to changes. Please also observe the further product documentation!



**Item no.: 210-508**

Steel carrier rail; 35 x 15 mm; 1.5 mm thick; 2 m long; slotted; galvanized; similar to EN 60715; silver-colored

[www.wago.com/210-508](http://www.wago.com/210-508)



**Item no.: 210-113**

Steel carrier rail; 35 x 7.5 mm; 1 mm thick; 2 m long; unslotted; according to EN 60715; silver-colored

[www.wago.com/210-113](http://www.wago.com/210-113)



**Item no.: 210-118**

Steel carrier rail; 35 x 15 mm; 2.3 mm thick; 2 m long; unslotted; according to EN 60715; silver-colored

[www.wago.com/210-118](http://www.wago.com/210-118)



**Item no.: 210-112**

Steel carrier rail; 35 x 7.5 mm; 1 mm thick; 2 m long; slotted; according to EN 60715; "Hole width 25 mm; silver-colored

[www.wago.com/210-112](http://www.wago.com/210-112)



**Item no.: 210-114**

Steel carrier rail; 35 x 15 mm; 1.5 mm thick; 2 m long; unslotted; similar to EN 60715; silver-colored

[www.wago.com/210-114](http://www.wago.com/210-114)



**Item no.: 210-115**

Steel carrier rail; 35 x 7.5 mm; 1 mm thick; 2 m long; slotted; according to EN 60715; "Hole width 18 mm; silver-colored

[www.wago.com/210-115](http://www.wago.com/210-115)

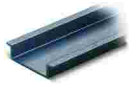

**Item no.: 210-196**

Aluminum carrier rail; 35 x 8.2 mm; 1.6 mm thick; 2 m long; unslotted; similar to EN 60715; silver-colored

[www.wago.com/210-196](http://www.wago.com/210-196)

**Shield termination**

Shield clamping saddles



**Item no.: 790-116**

Shield clamping saddle; 19 mm wide; diameter of compatible conductor; 7 ... 16 mm

[www.wago.com/790-116](http://www.wago.com/790-116)



**Item no.: 790-124**

Shield clamping saddle; 27 mm wide; diameter of compatible conductor; 6 ... 24 mm

[www.wago.com/790-124](http://www.wago.com/790-124)



**Item no.: 790-108**

Shield clamping saddle; 11 mm wide; diameter of compatible conductor; 3 ... 8 mm

[www.wago.com/790-108](http://www.wago.com/790-108)



**Item no.: 790-140**

Shield clamping saddle; diameter of compatible conductor

[www.wago.com/790-140](http://www.wago.com/790-140)



**Item no.: 790-216**

Shield clamping saddle; 21.8 mm wide; 6 ... 16 mm

[www.wago.com/790-216](http://www.wago.com/790-216)



**Item no.: 790-220**

Shield clamping saddle; 30 mm wide; 6 ... 20 mm

[www.wago.com/790-220](http://www.wago.com/790-220)



**Item no.: 790-208**

Shield clamping saddle; 12.4 mm wide; 3 ... 8 mm

[www.wago.com/790-208](http://www.wago.com/790-208)

**Downloads**

**Documentation**

**Manual**

Subject to changes. Please also observe the further product documentation!

WAGO GmbH & Co. KG

Hansastr. 27

32423 Minden

Phone: +49571 887-0 | Fax: +49571 887-169

Email: [info.de@wago.com](mailto:info.de@wago.com) | Web: [www.wago.com](http://www.wago.com)

Do you have any questions about our products?

We are always happy to take your call at +49 (571) 887-44222.



System Manual WAGO I/O System 750/753 Decentralized Automation Technology	V 3.3.0 2023 May 4	pdf 8.8 MB	Download
Product Manual 2-channel, 0-10VDC, single-ended	V 1.0.4	pdf 2.0 MB	Download
System Manual Series 750/753 Online HTML		URL	Download
<b>Bid Text</b>			
750-467 X81 - Datei	2019 Sep 16	xml 5.8 kB	Download
750-467 docx - Datei	2017 Jun 28	docx 17.2 kB	Download
750-467 doc - Datei	2017 Jun 28	doc 28.2 kB	Download
ausschreiben.de 750-467		URL	Download
<b>Instruction Leaflet</b>			
CCC Ex (Additional information) WAGO-I/O-SYSTEM *750-****/*	2023 Apr 26	pdf 163.6 kB	Download
<b>System Description</b>			
750/753 Series I/O-System – General Product Information		pdf 1.7 MB	Download
Overview on WAGO-I/O-SYSTEM 750 approvals		pdf 789.0 kB	Download
<b>Additional Information</b>			
Disposal and Recycling Electrical and electronic equipment, Batteries, Packaging	V 1.1.0 2022 Aug 18	pdf 2.2 MB	Download
<b>CAD/CAE-Data</b>			
<b>CAD data</b>			
2D/3D Models 750-467		URL	Download

Subject to changes. Please also observe the further product documentation!



#### CAE data

<a href="#">EPLAN Data Portal 750-467</a>	<a href="#">URL</a>	<a href="#">Download</a>
<a href="#">WSCAD Universe 750-467</a>	<a href="#">URL</a>	<a href="#">Download</a>
<a href="#">ZUKEN Portal 750-467</a>	<a href="#">URL</a>	<a href="#">Download</a>

#### Device Files

##### Device Driver

<a href="#">WAGO USB Service Kabel Treiber / Serie 750 und 857</a>	6.5.3.0 2014 Sep 10	zip 4.8 MB	<a href="#">Download</a>
--	------------------------	---------------	--------------------------

#### Environmental Product Compliance

##### Compliance Search

<a href="#">Environmental Product Compliance 750-467</a> 2-channel analog input; 0 ... 10 VDC; Single-ended	<a href="#">URL</a>	<a href="#">Download</a>
--	---------------------	--------------------------

#### Installation Notes

#### Product family

[WAGO I/O System 750/753](#)  
[Show all products from the family](#)

Subject to changes. Please also observe the further product documentation!