

Item description

Distribution connector *WINSTA*® MIDI I coding

The *WINSTA*® MIDI distribution connector with protection type IP20 allows installation of fine-stranded and solid conductors. On PCBs, in control cabinets or for connecting lights – pluggable installation connectors from WAGO allow you to establish connections according to a huge variety of requirements in next to no time. For greater protection in electrical installations, the pluggable installation connector is equipped with mechanical protection against mismatching. The pluggable installation connector is protected in accordance with protection type IP20 (When mated: IP2xC (These compact connectors are not designed for use in open, easily accessible areas!)). This means that users' fingers will never come into contact with energised elements. *WINSTA*® MIDI pluggable installation connectors with I coding in blue are especially suitable for lighting management, for example for the dimming function of DALI lights. The rated current and voltage are important criteria for selecting a pluggable installation connector:

Subject to changes. Please also observe the further product documentation!



They provide information about possible domains of use and applications. This product has a current rating of 25 A – as a result it is also suitable for high power loads. The *WINSTA*® MIDI Pluggable Connection System with Push-in CAGE CLAMP® spring pressure connection technology facilitates exemplary electrification. Due to the integrated test slot, connections can be checked even when they are plugged in. This saves time, labor, and money.

Push-in CAGE CLAMP® spring pressure connection technology – pluggable installation instead of laborious screw connections!

The *WINSTA*® Pluggable Connection System is ideally tailored to the strict requirements of building installation. It makes electrical installation pluggable, and consequently faster, more reliable, and error-free. Use of this pre-assembled system reduces assembly times and errors during installation at the construction site. Choose quality and durability – the *WINSTA*® MIDI pluggable installation connector with locking lever from WAGO makes the installation of electrical components noticeably easier.

- effective protection against mismatching
- pre-assembled versions
- with I coding for use in the automation of buildings (lighting control)
- flexible installation to save space
- convenient installation and commissioning

Data

Electrical data

Ratings per IEC/EN

Ratings per	IEC/EN 60664-1
Nominal voltage (III/3)	400 V
Rated impulse voltage (III/3)	6 kV
Rated current	25 A
Legend (ratings)	(III / 3) ≙ Overvoltage category III / Pollution degree 3

Ratings per UL 1977

Note for the US market	Some versions may also be used for current interruption in accordance with the UL certificate in select applications with currents below 16 A and voltages up to 600 V. For further information, please contact your local sales office.
Rated voltage (UL 1977)	600 V
Rated current UL 1977	23 A

Subject to changes. Please also observe the further product documentation!



General

Note on contact resistance	approx. 1 mΩ of contact resistance approx. 0.25 mΩ contact transition plug/socket
----------------------------	--

Connection data

Total number of potentials	5
PE function	Preceding PE contact

Connection 1

Pole number	5
-------------	---

Physical data

Pin spacing	10 mm / 0.394 inches
Width	50 mm / 1.969 inches
Height	58.2 mm / 2.291 inches
Depth	46 mm / 1.811 inches

Mechanical Data

Application	DALI, Lighting Management
Coding	I
Variable coding	No
Marking	N \perp L DA- DA+
Potential marking	N \perp L DA- DA+
Mating force of a plug-in connection	approx. 20 ... 70 N (depending on pole number)
Retention force of a plug-in connection	When locked: > 80 N
Unmating force of a plug-in connection	Unlocked: approx. 20 ... 70 N (depending on pole number)
Number of mating cycles	200, without resistive load
Type of distribution box	Distribution connector, 5-way
Protection type	IP20; When mated: IP2xC (These compact connectors are not designed for use in open, easily accessible areas!)

Plug-in connection

Contact type (pluggable connector)	Socket/plug
Mismating protection	Yes
Note on mismating protection	All WINSTA [®] components are 100% protected against mismating when:

Subject to changes. Please also observe the further product documentation!



- a.) plugging different numbers of poles
- b.) plugging while rotated 180
- c.) plugging while laterally staggered
- d.) plugging one pole

Locking lever	yes
Locking of plug-in connection	locking lever
Note on locking system	All connectors for mounted installations (snap-in versions for lighting fixtures or devices, all types of PCB and distribution connectors) are factory-equipped with locking levers to ensure plugs and sockets are securely locked. Additional locking levers are only required for flying leads (plug/socket).
Number of locking levers	6

Material Data

Note (material data)

Information on material specifications can be found here

Insulation material	Polyamide (PA66)
Flammability class per UL94	V0
Contact material	Copper or copper alloy; surface-treated
Contact plating	Tin
Fire load	1.04 MJ
Weight	64 g

Environmental requirements

Processing temperature	-5 ... +40 °C
Continuous operating temperature	-35 ... +85 °C
Note on continuous operating temperature	Insulating parts for temperatures \leq 105 °C

Commercial data

eCl@ss 10.0	27-44-06-03
eCl@ss 9.0	27-44-06-03
ETIM 8.0	EC002567
ETIM 7.0	EC002567
PU (SPU)	20 pcs
Packaging type	box
Country of origin	DE
GTIN	4055143706940
Customs tariff number	85366990990

Subject to changes. Please also observe the further product documentation!

WAGO GmbH & Co. KG
 Hansastr. 27
 32423 Minden
 Phone: +49571 887-0 | Fax: +49571 887-169
 Email: info.de@wago.com | Web: www.wago.com







Do you have any questions about our products?
 We are always happy to take your call at +49 (571) 887-44222.

Environmental Product Compliance

RoHS Compliance Status

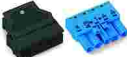
Compliant, No Exemption



Counterpart

	Item no. 770-1105 Socket; 5-pole; Cod. I; 4,00 mm ² ; blue	www.wago.com/770-1105
	Item no. 770-1105/022-000 Socket; with strain relief housing; 5-pole; Cod. I; 4,00 mm ² ; blue	www.wago.com/770-1105/022-000
	Item no. 770-1115/022-000 Plug; with strain relief housing; 5-pole; Cod. I; 4,00 mm ² ; blue	www.wago.com/770-1115/022-000
	Item no. 770-1115 Plug; 5-pole; 4,00 mm ² ; blue	www.wago.com/770-1115
	Item no. 771-9985/106-101 pre-assembled connecting cable; Eca; Socket/open-ended; 5-pole; Cod. I; H05VV-F 5G 1.5 mm ² ; 1 m; 1,50 mm ² ; blue	www.wago.com/771-9985/106-101
	Item no. 771-9985/006-101 pre-assembled interconnecting cable; Eca; Socket/plug; 5-pole; Cod. I; H05VV-F 5G 1.5 mm ² ; 1 m; 1,50 mm ² ; blue	www.wago.com/771-9985/006-101
	Item no. 771-9985/206-101 pre-assembled connecting cable; Eca; Plug/open-ended; 5-pole; Cod. I; H05VV-F 5G 1.5 mm ² ; 1 m; 1,50 mm ² ; blue	www.wago.com/771-9985/206-101

Optional accessories



Mounting

Mounting accessories

	Item no.: 770-625 Mounting plate; 5-pole; for distribution connectors; Plastic; black	www.wago.com/770-625
	Item no.: 770-675 Mounting plate; 5-pole; for distribution connectors; Plastic; white	www.wago.com/770-675

Cover

Cover

	Item no.: 770-360 Lockout cap; for plugs; 5-pole; separable; yellow	www.wago.com/770-360
	Item no.: 770-201 Lockout cap; 12-pole, separable; for sockets; Plastic; black	www.wago.com/770-201

Subject to changes. Please also observe the further product documentation!

WAGO GmbH & Co. KG

Hansastr. 27

32423 Minden

Phone: +49571 887-0 | Fax: +49571 887-169

Email: info.de@wago.com | Web: www.wago.com

Do you have any questions about our products?

We are always happy to take your call at +49 (571) 887-44222.

Item no.: 770-221

Lockout cap; 12-pole, separable; for sockets; Plastic; white

www.wago.com/770-221

Downloads

Documentation

Bid Text

770-1947 X81 - Datei	2019 Feb 19	xml 2.8 kB	Download
770-1947 doc - Datei	2018 Mar 21	doc 23.0 kB	Download
ausschreiben.de 770-1947		URL	Download

Environmental Product Compliance

Compliance Search

Environmental Product Compliance 770-1947 5-way distribution connector; 5-pole; Cod. I; 1 input; 5 outputs	URL	Download
---	-----	----------

Installation Notes

Installation

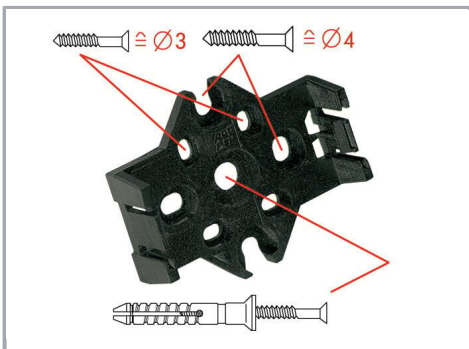

Mounting plates can be secured using commercially available screws or nail-drive anchors.



The distribution connectors snap together when attached to the mounting plate.

Subject to changes. Please also observe the further product documentation!



To release the distribution connector, unlock the latch using a screwdriver.

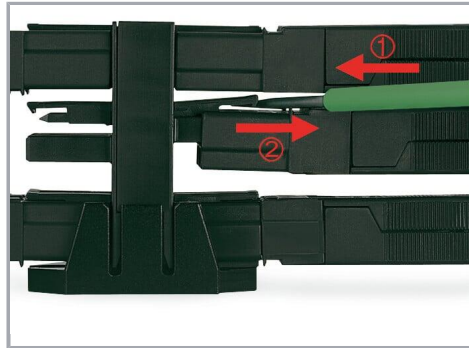

All distribution connector connections are locked and protected against accidental disconnection directly after mating. Locking of any connection is released using a screwdriver, even if all connections are used.

Product family

WINSTA® MIDI

[Show all products from the family](#)

Subject to changes. Please also observe the further product documentation!