

nanoSplatch™ nSP250 Embedded WiFi/WLAN Antenna

The nanoSplatch™ nSP250 is a surface-mount antenna for embedded WiFi/WLAN and other 2.4 GHz or 5.8 GHz ISM or U-NII frequency band applications. It uses a grounded-line technique to achieve outstanding performance in a tiny surface-mount package. The nSP250 exhibits low proximity effect with a very hemispherical radiation pattern, making it ideal for handheld devices and applications typically subject to interference.

The nSP250 is available in tape and reel packaging and is designed for reflow-solder mounting directly to a printed circuit board for high-volume applications.



Features

- Ultra-compact package (9.6 mm x 8.4 mm x 1.1 mm)
- Excellent performance with smallest ground plane (40 mm x 20 mm)
- Resistant to proximity effect
- Omnidirectional radiation pattern
- Direct surface-mount PCB attachment
- Reflow- or hand-solder assembly
- High gain (2.7 dBi at 2.4 GHz, 3.7 dBi at 5.8 GHz)
- High efficiency (66% at 2.4 GHz, 69% at 5.8 GHz)

Applications

- Single- and dual-band WiFi/WLAN/802.11
- Bluetooth® and ZigBee®
- Smart Home networking
- Sensing and remote monitoring
- Hand-held devices
- Internet of Things (IoT) devices
- U-NII and ISM applications

Ordering Information

Part Number	Description
ANT-DB1-nSP250-B	Bulk quantities supplied in cut tape
ANT-DB1-nSP250-T	Tape and reel (1000 per reel)
AEK-DB1-nSP250	Antenna evaluation kit

Available from Linix Technologies and select distributors and representatives.

Electrical Specifications

	2.4 GHz ISM	U-NII	5.8 GHz ISM/ U-NII-3
Frequency Range	2.4 GHz to 2.5 GHz	5.150 GHz to 5.725 GHz	5.725 GHz to 5.875 GHz
VSWR	≤ 2.0 : 1	≤ 2.2 : 1	≤ 2.4 : 1
Peak Gain	2.7 dBi	4.3 dBi	3.7 dBi
Average Gain	-1.8 dBi	-1.9 dBi	-1.6 dBi
Efficiency	65%	60%	70%
Polarization	Linear		
Radiation	Omnidirectional		
Max Power	5 W		
Wavelength	1/4-wave		
Impedance	50 Ω		
Connection	Surface-mount		
Weight	0.16 g (0.006 oz)		
Dimensions	9.6 mm x 8.4 mm x 1.1 mm (0.38 in x 0.33 in x 0.04 in)		
Operating Temperature	-40 °C to +130 °C		
ESD Sensitivity	NOT ESD sensitive. As a best practice, Linx may use ESD packaging.		

Electrical specifications and plots measured with a 40 mm x 20 mm (1.6 in x 0.8 in) reference ground plane.

VSWR

Figure 1 provides the voltage standing wave ratio (VSWR) across the nSP250 bandwidth. The target 2.4 GHz and 5.8 GHz ISM bands used for WiFi/WLAN are highlighted, as is the U-NII band. VSWR describes the power reflected from the antenna back to the radio. A lower VSWR value indicates better antenna performance at a given frequency. Reflected power is also shown on the right-side vertical axis as a gauge of the percentage of transmitter power reflected back from the antenna.

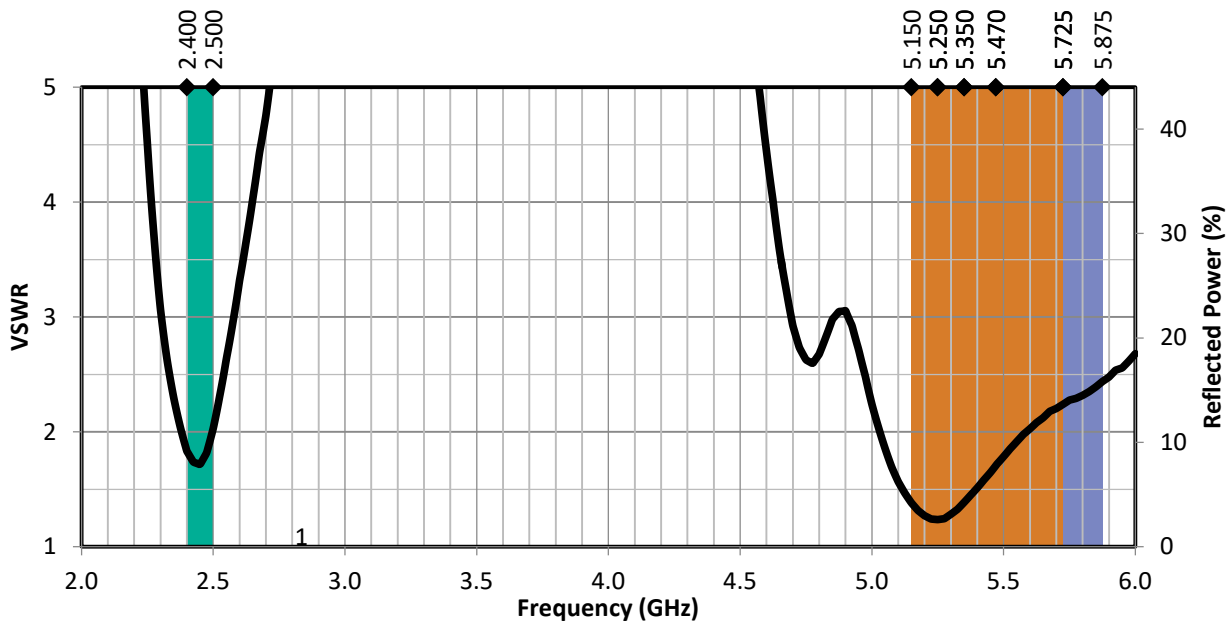

Figure 1. nSP250 VSWR with Frequency Band Highlights

Return Loss

Return loss (Figure 2), represents the loss in power at the antenna due to reflected signals. Like VSWR, a lower return loss value indicates better antenna performance at a given frequency.

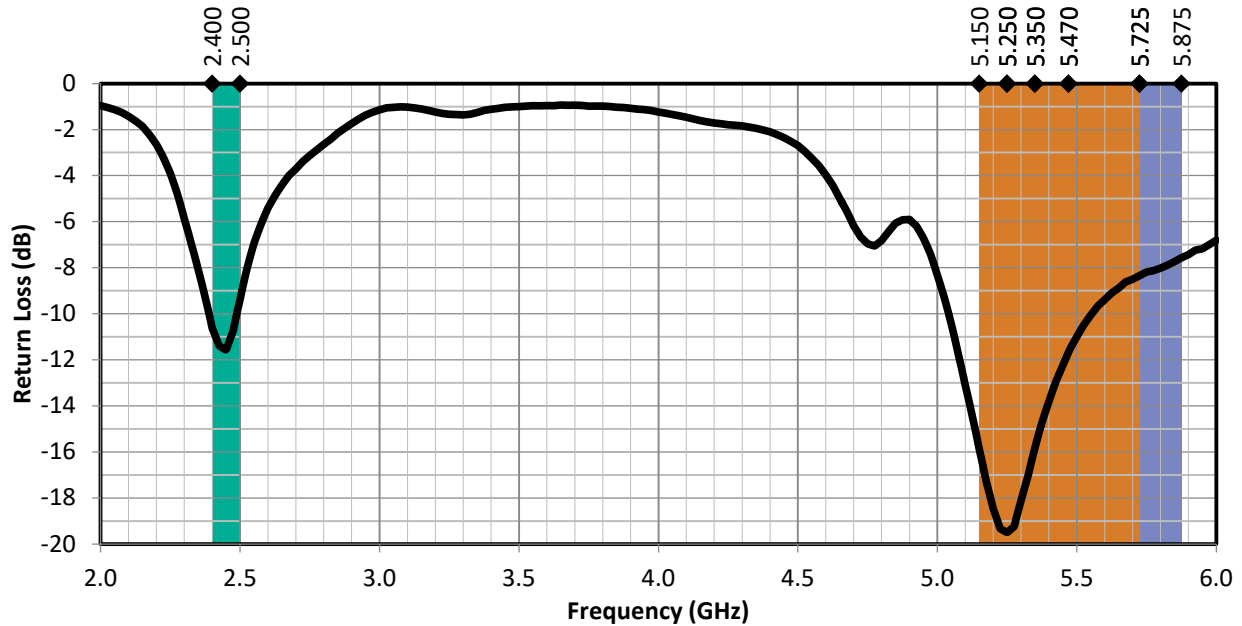

Figure 2. nSP250 Return Loss with Frequency Band Highlights

Peak Gain

The peak gain across the nSP250 bandwidth is shown in Figure 3. Peak gain represents the maximum antenna input power concentration across 3-dimensional space, and therefore peak performance at a given frequency, but does not consider any directionality in the gain pattern.

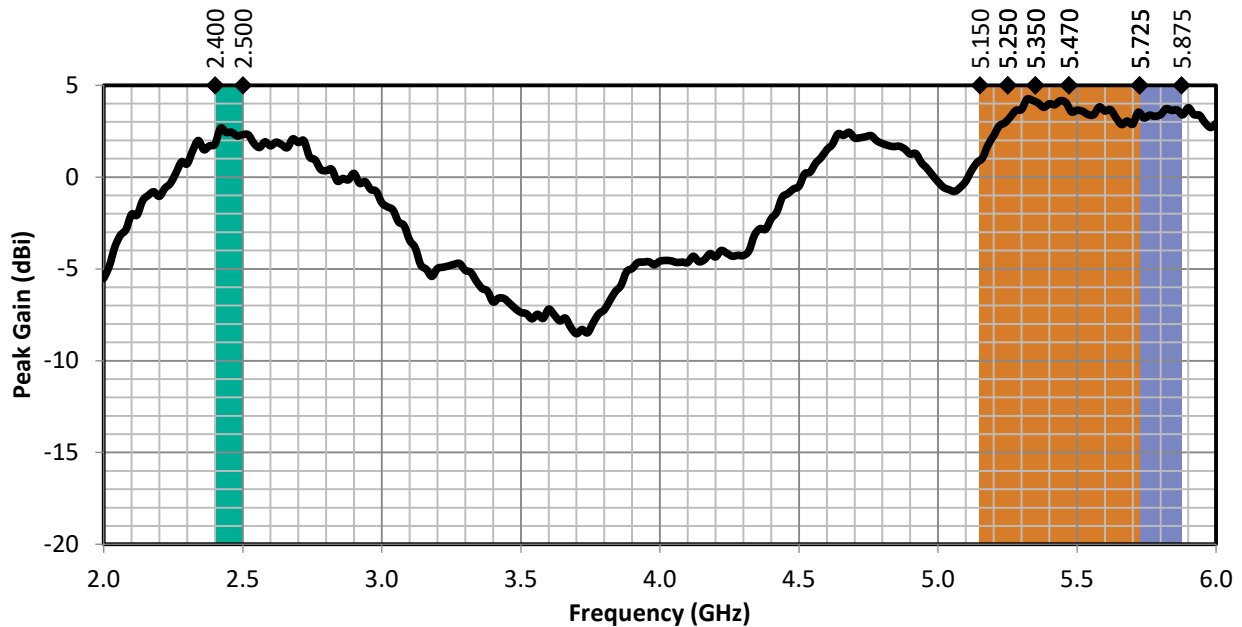

Figure 3. nSP250 Peak Gain with Frequency Band Highlights

Average Gain

Average gain (Figure 4), is the average of all antenna gain in 3-dimensional space at each frequency, providing an indication of overall performance without expressing antenna directionality.

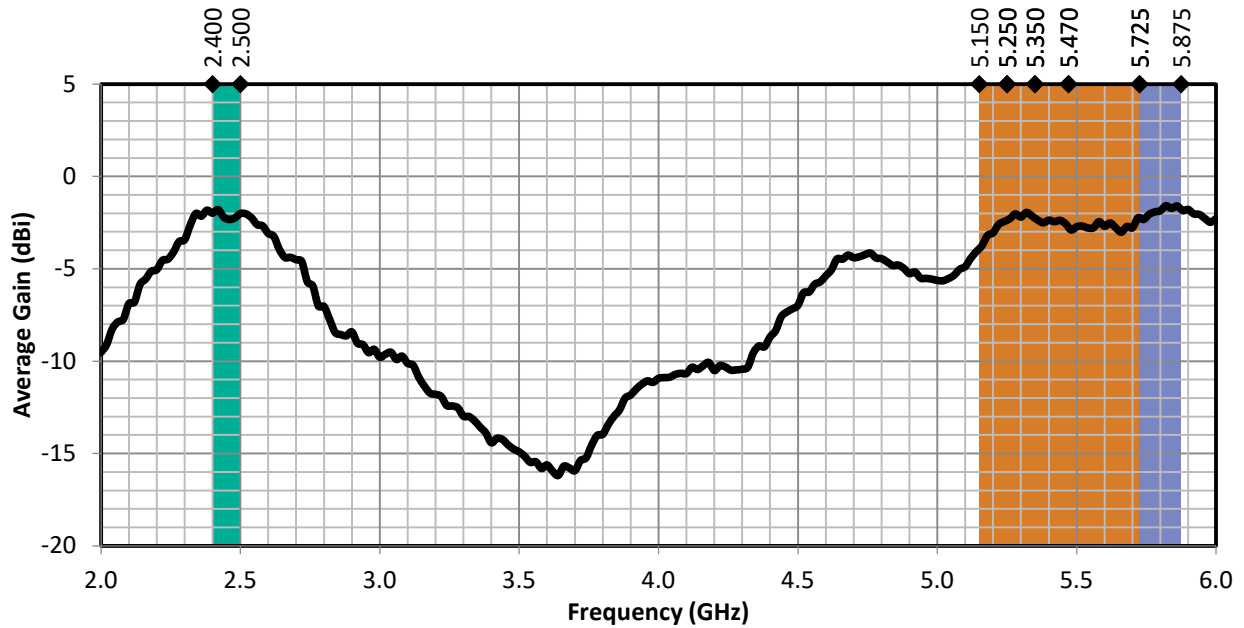

Figure 4. nSP250 Average Gain with Frequency Band Highlights

Radiation Efficiency

Radiation efficiency (Figure 5), shows the ratio of power delivered to the antenna relative to the power radiated at the antenna, expressed as a percentage, where a higher percentage indicates better performance at a given frequency.

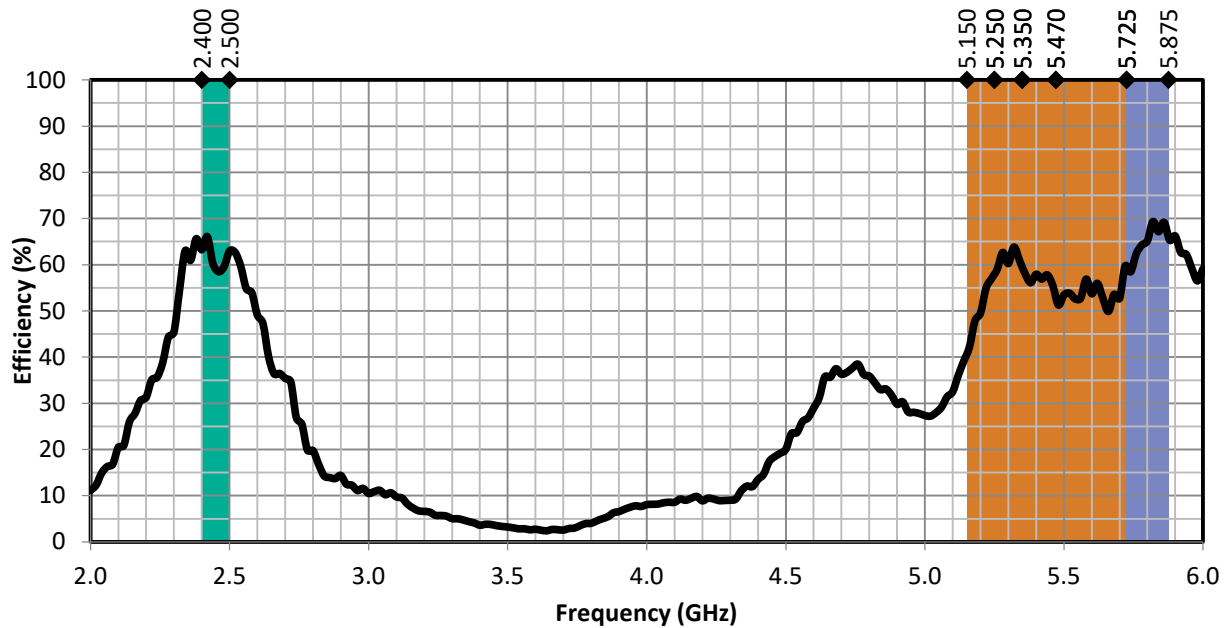

Figure 5. nSP250 Radiation Efficiency with Frequency Band Highlights

Product Dimensions

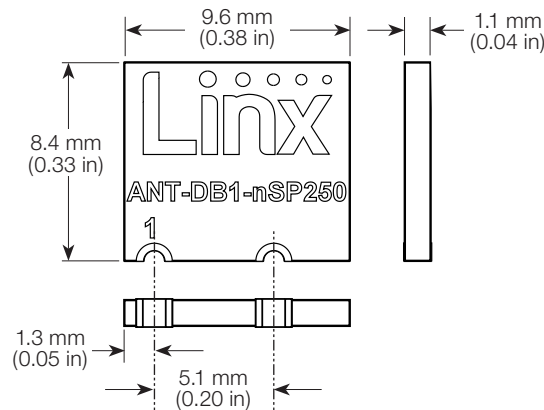

Figure 6. nSP250 Dimensions

Product Signals

The signal definitions for the nSP250 are provided in Figure 7.

Function	Description
Rx/Tx	Castellation marked as “1”
GND	Unmarked castellation

Figure 7. nSP250 Pin-Out Table

Proximity Effect

Wireless devices are often designed based on antenna performance measured on an evaluation board. In practice, however, many wireless devices are used in the presence of materials near the antenna which were not present during evaluation. These materials, such as batteries, components on the PCB, or even a person’s body or hand¹, can cause a shift in the frequency performance of the antenna, resulting in less than optimal device performance. The shift in the frequency performance can be quite dramatic, especially for monopole (1/4 wavelength) antennas.

The nSP250 antenna is designed to help reduce the impact of nearby objects on the performance of the antenna by using a grounded line technique to reduce the overall length of the antenna radiator to provide wider bandwidth for better immunity to frequency shifts, while using a multilayer PCB to maintain a lower profile and small size. Matching components can be added, if necessary, to mitigate larger proximity effects from features like metal shields or enclosures.

Radiation Patterns

Radiation patterns provide information about the directionality and 3-dimensional gain performance of the antenna by plotting gain at specific frequencies in three orthogonal planes. Radiation patterns (Figure 8), are shown using polar plots covering 360 degrees. The antenna graphic above the plots provides reference to the plane of the column of plots below it. Note: when viewed with typical PDF viewing software, zooming into radiation patterns is possible to reveal fine detail.

Notes

¹ Antenna Proximity Effects for Talk and Data Modes in Mobile Phones; M. Pelosi, et al; IEEE Antennas and Propagation Magazine, Vol. 52, Issue 3, June 2010

Radiation Patterns

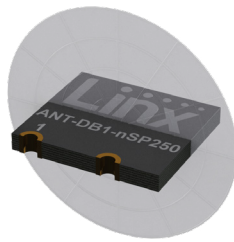

XZ-Plane Gain

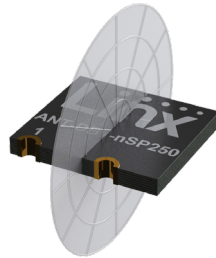

YZ-Plane Gain

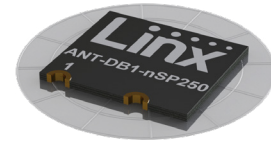

XY-Plane Gain

2.4 GHz to 2.5 GHz

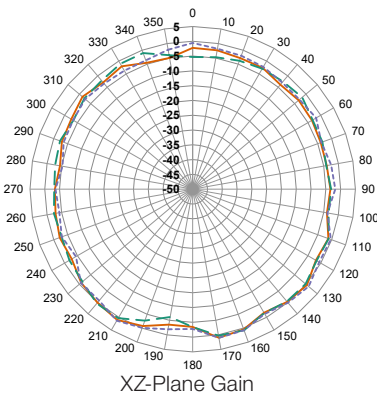

XZ-Plane Gain

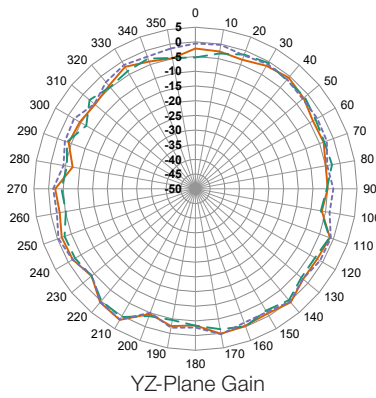

YZ-Plane Gain

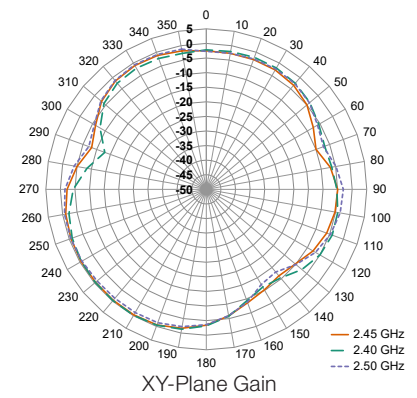

XY-Plane Gain

5.15 GHz to 5.73 GHz

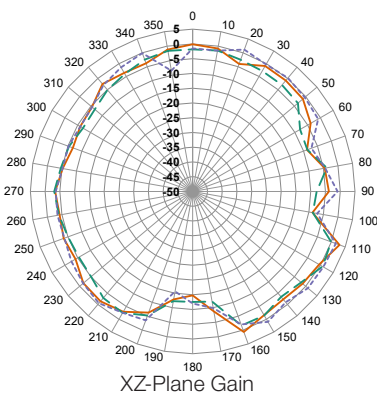

XZ-Plane Gain

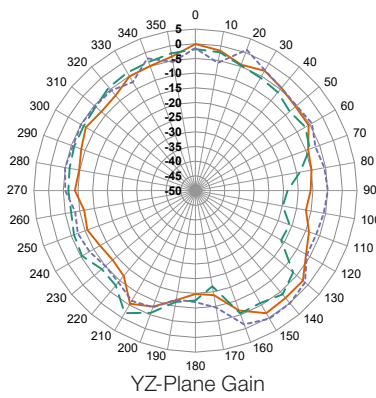

YZ-Plane Gain

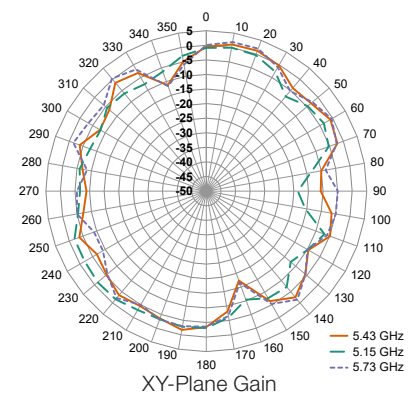

XY-Plane Gain

5.72 GHz to 5.88 GHz

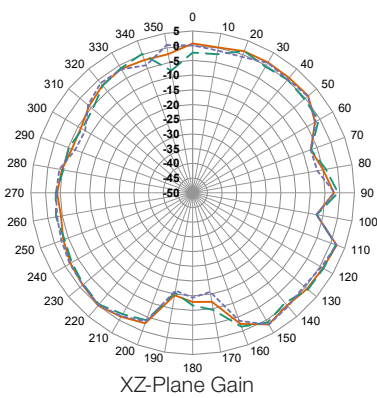

XZ-Plane Gain

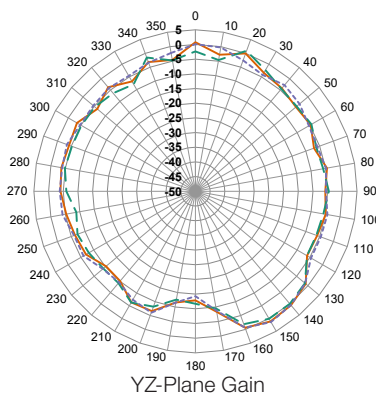

YZ-Plane Gain

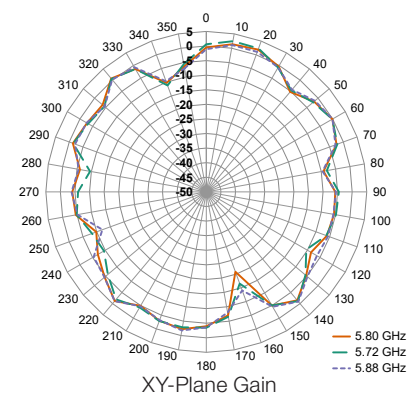

XY-Plane Gain

Figure 8. nSP250 Radiation Patterns

Recommended Layout

The recommended printed circuit board (PCB) layout for the nSP250 is shown in Figure 9. This layout is used for the nSP250 evaluation board which is available for purchase as listed under Ordering Information. Contact Linx for availability of PCB layout design files.

The recommended layout includes a matching network, ground plane and PCB transmission line from the antenna to the matching network, and to the connector or radio circuitry. The connector used for the evaluation board is optional, the transmission line may be run directly to the radio if on the same PCB.

Linx recommends inclusion of a 3-element, surface mount Pi matching network of two parallel capacitors, (C1, C2) and one serial inductor, (L1) in all designs. Surface mount components should be 0603 size. 0402 size components are also supported. The nSP250, as designed, does not require matching, but matching may improve end-product antenna performance depending on the effects of the enclosure, PCB and other electronic components. If no matching is necessary, the serial element may be populated with a zero-ohm resistor and no components in the two capacitor positions. This is the configuration of the Linx evaluation board as supplied. Linx believes in wireless made simple[®] and offers matching network design support.

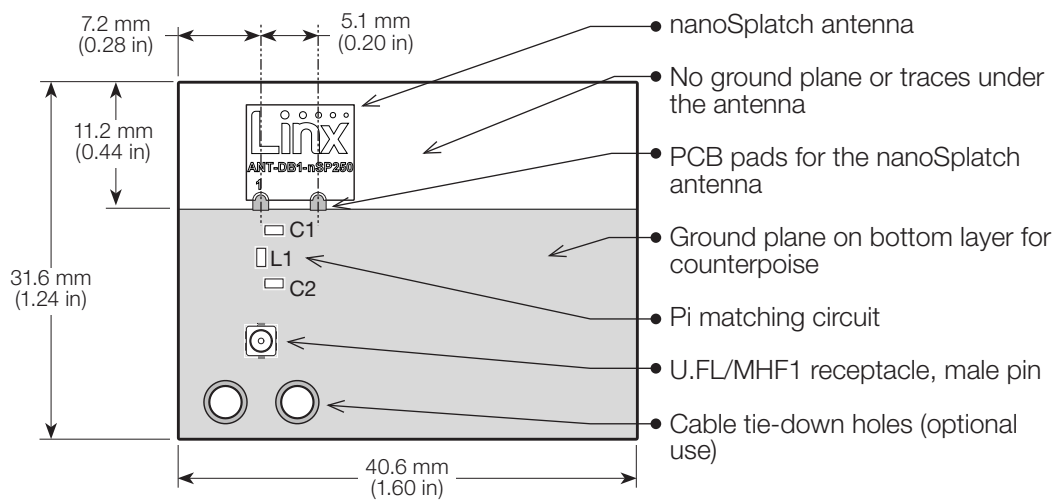

Figure 9. Linx nSP250 Recommended Layout

Recommended PCB Footprint

Figure 10 shows the recommended printed circuit board footprint and spacing for the nSP250 antenna. The footprint recommendation should be used in conjunction with the recommended layout configuration shown in Figure 9.

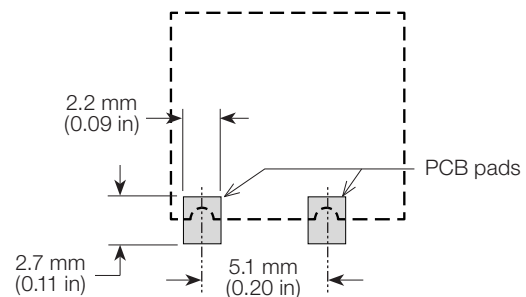

Figure 10. nanoSplat Placement on PCB

Ground Plane

The nSP250 is a 1/4-wave monopole antenna, and requires a ground plane on the PCB to which it is mounted. Linx recommends a 40 mm x 20 mm or larger ground plane. The nSP250 should be mounted at the edge of the ground plane (see Figure 9), and none of the ground plane should be underneath the antenna. Other ground plane sizes and antenna mounting locations are possible. Linx offers PCB design reviews to help optimize solution performance.

Transmission Lines for Embedded Antennas

For most designs, Linx recommends a microstrip transmission line for the nSP250. A microstrip transmission line is a PCB trace that runs over a ground plane to maintain the characteristic impedance for optimal signal transfer between the antenna and radio circuitry. Linx designs all antennas with a characteristic impedance of 50 Ω .

Important practices to observe when designing a transmission line are:

- Keep all transmission lines to a minimum length for best signal performance.
- Use RF components that also operate at a 50 Ω impedance.
- If the radio is not on the same PCB as the antenna the microstrip should be terminated in a connector enabling a shielded cable to complete the antenna connection to the radio, as exemplified on the nSP250 evaluation board.
- For designs subject to significant electromagnetic interference, a coplanar waveguide transmission line may be used on the PCB.

The design of a PCB transmission line can be aided by many commercially available software packages which can calculate the correct transmission line width and gap dimensions based upon the PCB thickness and dielectric constant used.

Reflow Solder Profile

The nSP250 uses a typical RoHS solder reflow profile. Refer to application note AN-00504 on the Linx website for more information.

Tape and Reel Packaging

Figure 11 shows the dimensions of the tape in which the nSP250 is packaged. Reel dimensions are provided in Figure 12.

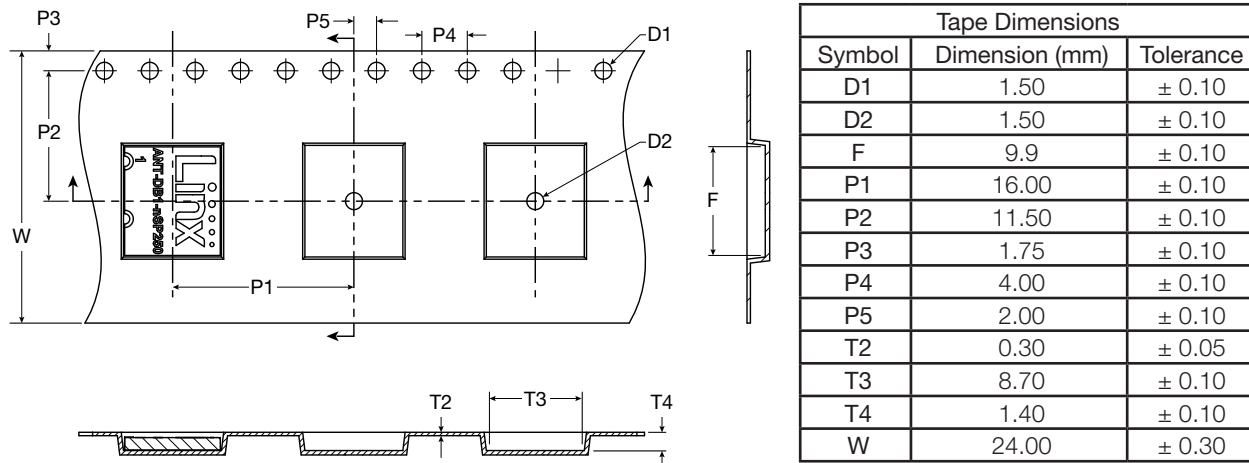

Figure 11. Tape Specifications for the nanoSplatch Antenna

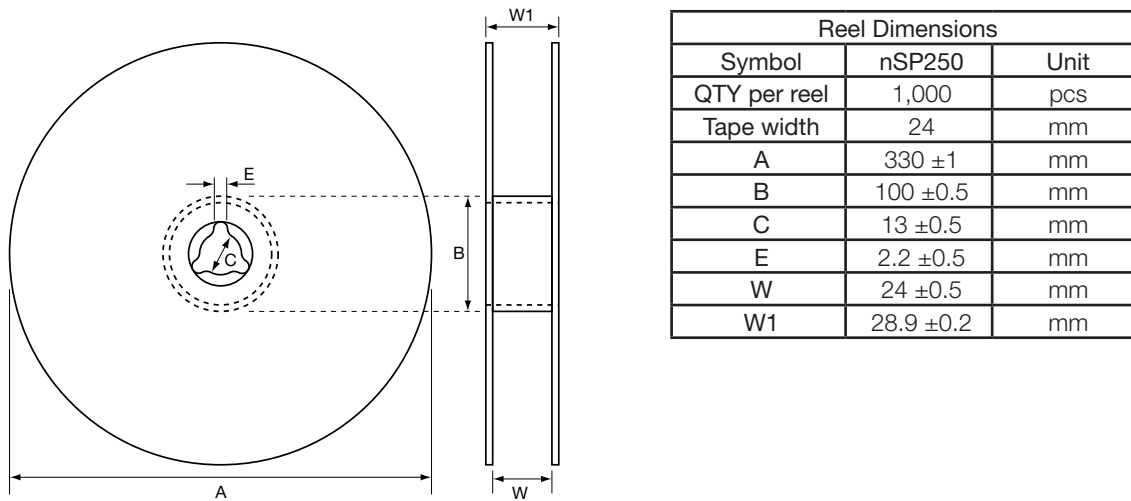

Figure 12. Reel Specifications for the nanoSplatch Antenna

Website: <http://linxtechnologies.com>
Linx Offices: 159 Ort Lane, Merlin, OR, US 97532
Phone: +1 (541) 471-6256
E-MAIL: info@linxtechnologies.com

Linx Technologies reserves the right to make changes to the product(s) or information contained herein without notice. No liability is assumed as a result of their use or application. No rights under any patent accompany the sale of any such product(s) or information.

Wireless Made Simple is a registered trademark of Linx Acquisitions LLC. nanoSplatch is a trademark of Linx Acquisitions LLC. Bluetooth is a registered trademark of Bluetooth SIG, Inc. ZigBee is a registered trademark of ZigBee Alliance, Inc. Other product and brand names may be trademarks or registered trademarks of their respective owners.

Copyright © 2019 Linx Technologies

All Rights Reserved

Doc # DS19204-01ANT (Replaces DS19151-01ANT)

