

Mechanical Dimensions: Inches [mm]

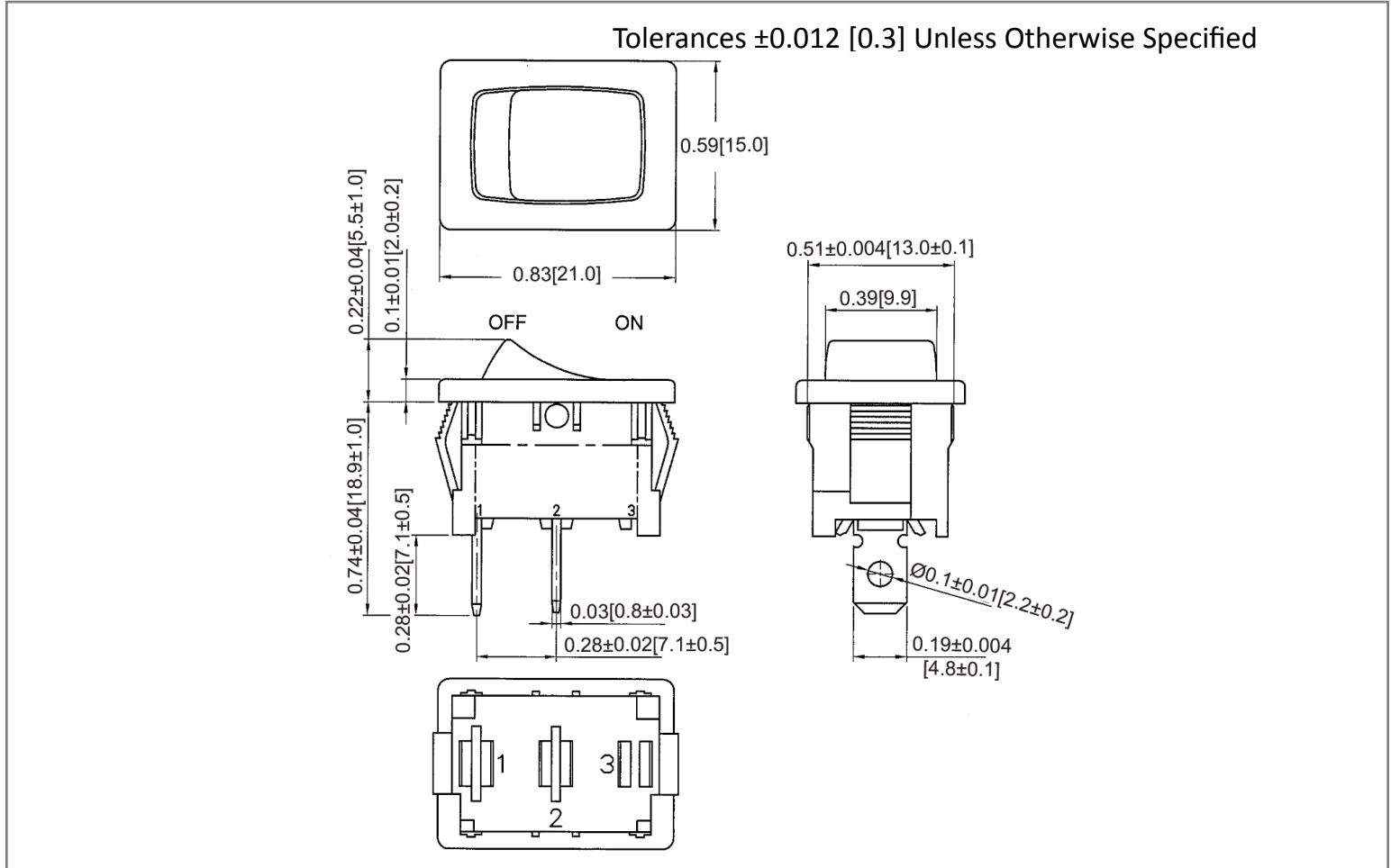

Mounting Hole

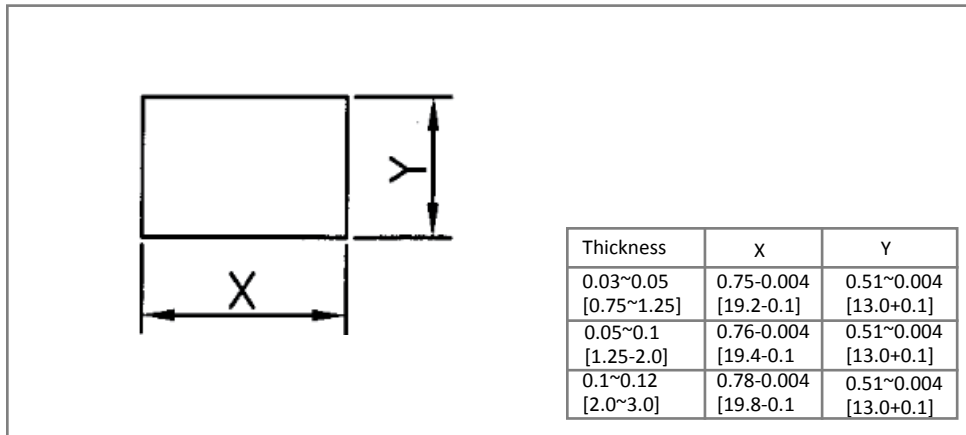

Circuit Diagram

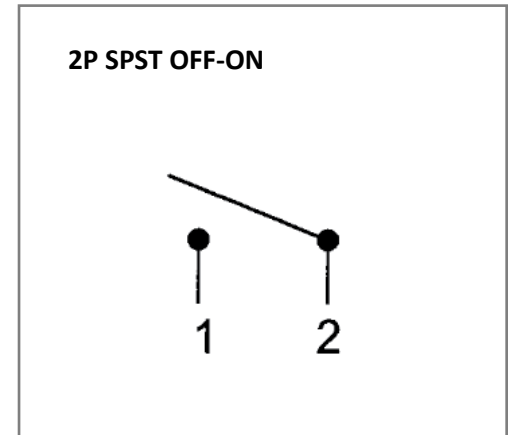

Electrical Specifications

Rating	16A 12V DC, 6A 28V DC
Contact Resistance	50m ohm Max
Insulation Resistance	DC 500V 100M ohm Min
Dielectric Strength	AC 1500V 1 minute
Operation Temperature	-25°C~85°C

Material Specifications

Frame	Black, Nylon 66
Actuator	Black, Nylon 66

Rev	Date of issue	Revision Notes	Designed	Approved
B	07-13-2021	Initial Drawing	RC	OF