

## CMSBN4615-HF

Dual N-Channel

RoHS Device

Halogen Free

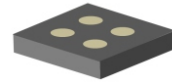

### Features

- It is ESD protected.
- This device is suitable for use as a unidirectional or bi-directional load switch, facilitated by its common-drain configuration.

### Mechanical data

- Case: CSPB1515-4, standard package, molded plastic.

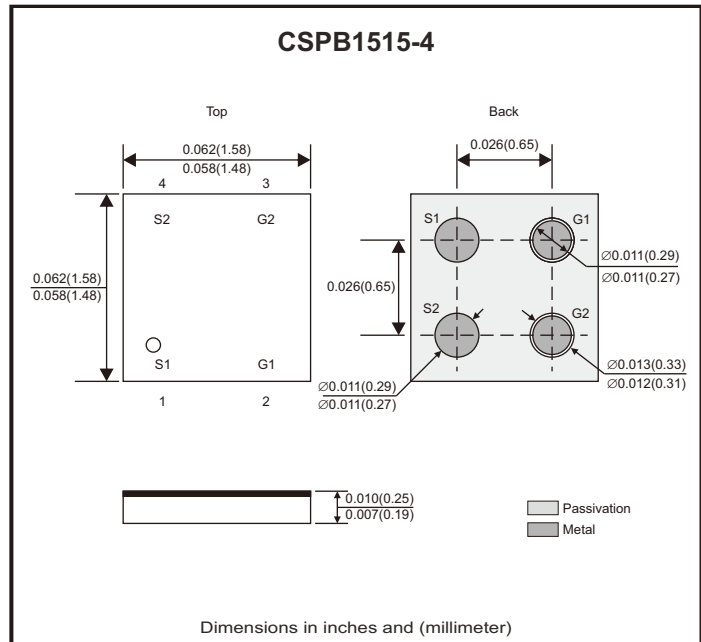

### Circuit diagram

- G : Gate
- S : Source

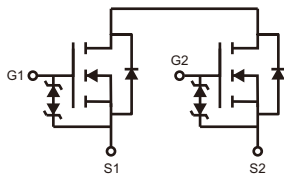

### Maximum Ratings (at TA=25°C unless otherwise noted)

Parameter	Symbol	Value	Unit
Source to source voltage	V <sub>SSS</sub>	20	V
Gate-source voltage	V <sub>GSS</sub>	±12	V
Source current DC (Note 1)	I <sub>S</sub>	7	A
Source current pulse (Note 1, 2)	I <sub>SP</sub>	60	A
Total dissipation (Note 1)	P <sub>T</sub>	1.5	W
Channel temperature	T <sub>ch</sub>	150	°C
Storage temperature range	T <sub>STG</sub>	-55 to +150	

Notes: 1. Mounted on FR4 board (25.4mm x 25.4mm x t1.0mm) using the minimum recommended pad size (36µm copper).

2. t = 10µs, duty cycle ≤ 1 %

## Electrical Characteristics (at $T_A=25^\circ\text{C}$ unless otherwise noted)

Parameter	Symbol	Conditions	Min	Typ	Max	Unit
<b>Static parameters</b>						
Source to source breakdown voltage	$BV_{SSS}$	$I_S = 250\mu\text{A}, V_{GS} = 0\text{V}$	20			V
Zero-gate voltage source current	$I_{SSS}$	$V_{SS} = 16\text{V}, V_{GS} = 0\text{V}$			1	$\mu\text{A}$
Gate to source leakage current	$I_{GSS}$	$V_{SS} = 0\text{V}, V_{GS} = \pm 8\text{V}$			$\pm 10$	$\mu\text{A}$
Cutoff voltage	$V_{GS(off)}$	$V_{SS} = 10\text{V}, I_S = 250\mu\text{A}$	0.5	0.8	1.3	V
Forward transfer admittance	$ y_{gfs} $	$V_{SS} = 10\text{V}, I_S = 3\text{A}$	1	9		S
Static source to source on-resistance	$R_{SS(on)}$	$V_{GS} = 4.5\text{V}, I_S = 3\text{A}$	14	20.5	26	m $\Omega$
		$V_{GS} = 4.0\text{V}, I_S = 3\text{A}$	15	21.5	27	
		$V_{GS} = 3.8\text{V}, I_S = 3\text{A}$	16	22	28	
		$V_{GS} = 3.1\text{V}, I_S = 3\text{A}$	18	23	30	
		$V_{GS} = 2.5\text{V}, I_S = 3\text{A}$	19	26	45	
Turn-on delay time	$t_{d(on)}$	$V_{SS} = 10\text{V}, I_S = 3\text{A}, V_{GS} = 4.5\text{V}$		0.9		$\mu\text{S}$
Turn-on rise time	$t_r$			4.6		
Turn-off delay time	$t_{d(off)}$			12		
Turn-off fall time	$t_f$			12		
Total gate charge	$Q_g$	$V_{SS} = 10\text{V}, I_S = 6\text{A}, V_{GS} = 4.5\text{V}$		11		nC
Diode forward voltage	$V_{F(S-S)}$	$V_{GS} = 0\text{V}, I_S = 1\text{A}$			1.2	V

## Rating and Characteristic Curves (CMSBN4615-HF)

Fig.1 - Output Characteristics

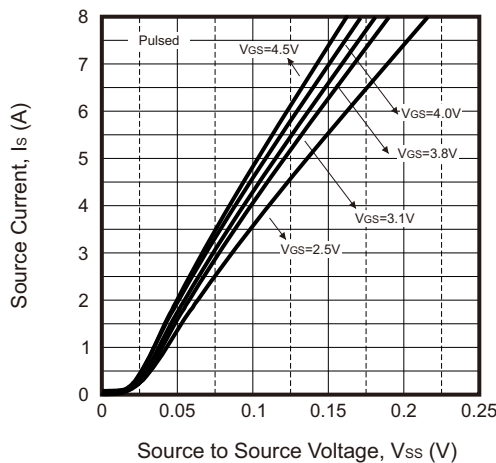
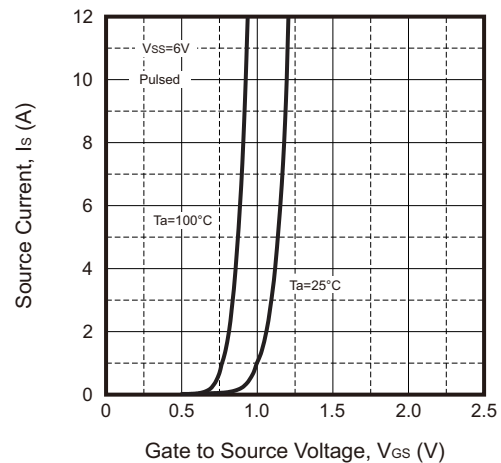

Fig.2 -  $I_S - V_{GS}$



## Rating and Characteristic Curves (CMSBN4615-HF)

Fig.3 -  $R_{SS(ON)}$  —  $I_s$

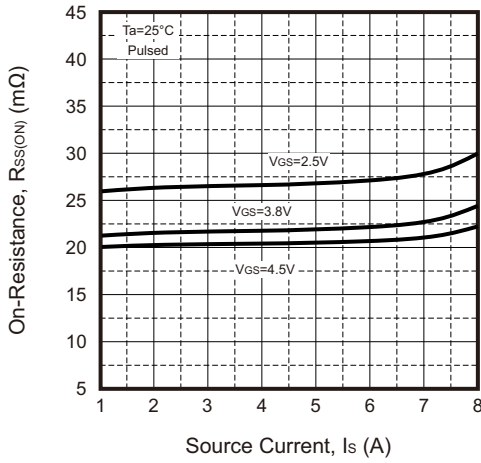

Fig.4 -  $R_{SS(ON)}$  —  $V_{GS}$

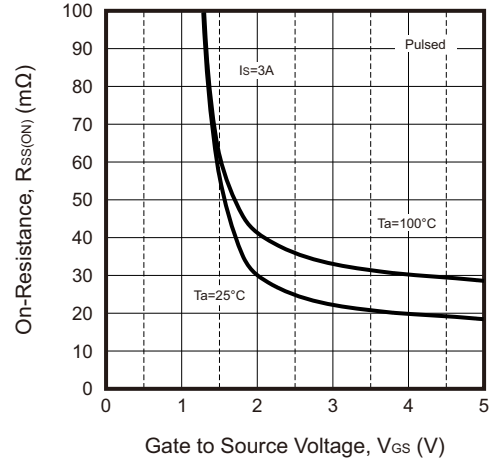

Fig.5 -  $I_s$  —  $V_{SS}$

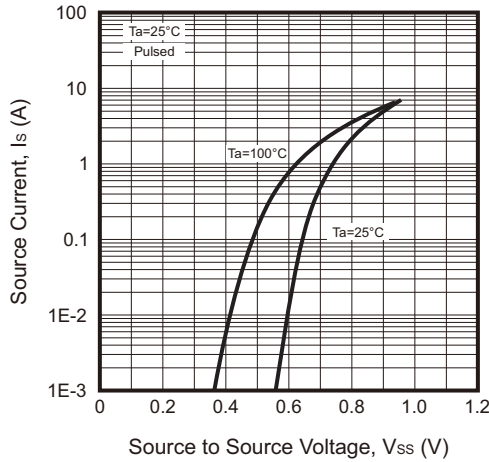

Fig.6 - Threshold Voltage

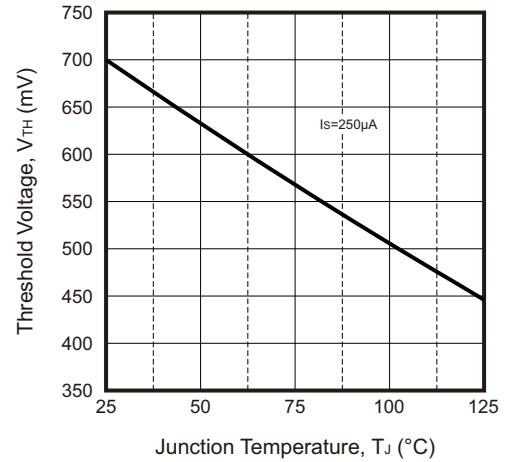

Fig.7 - Total Power Dissipation vs. Ambient Temperature

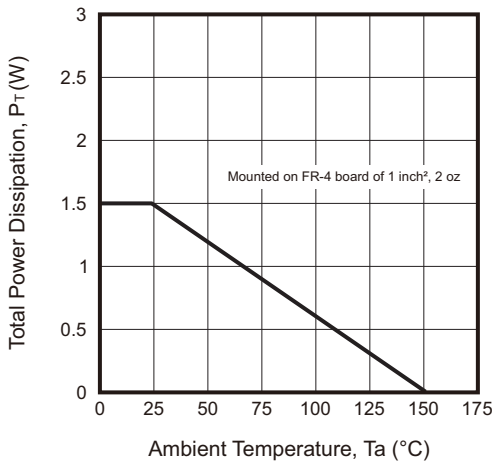
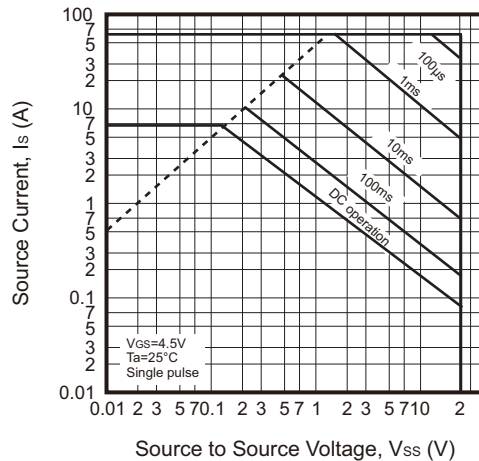
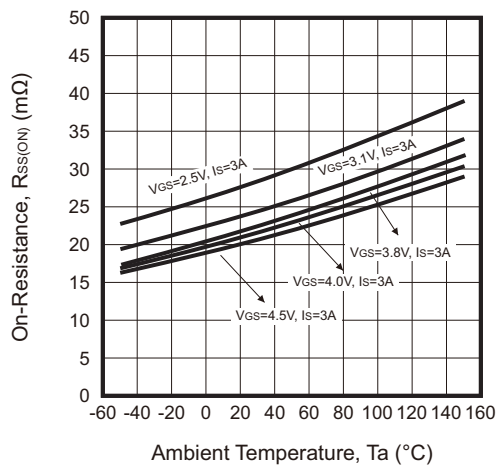

Fig.8 - Maximum Safe Operating Area



## Rating and Characteristic Curves (CMSBN4615-HF)

Fig.9 -  $R_{SS(ON)} - T_a$



## Reel Taping Specification

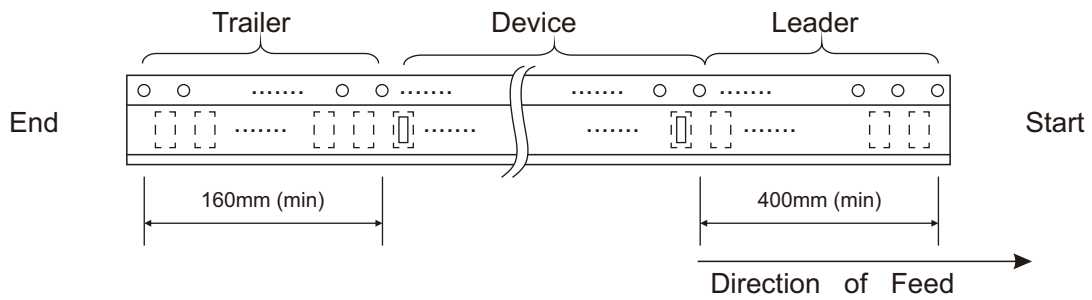
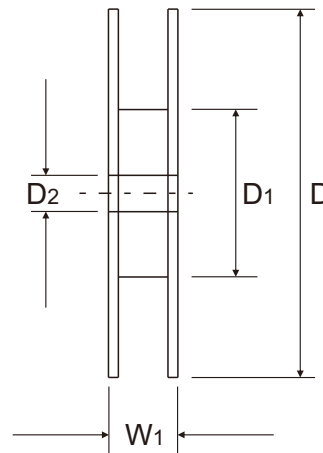
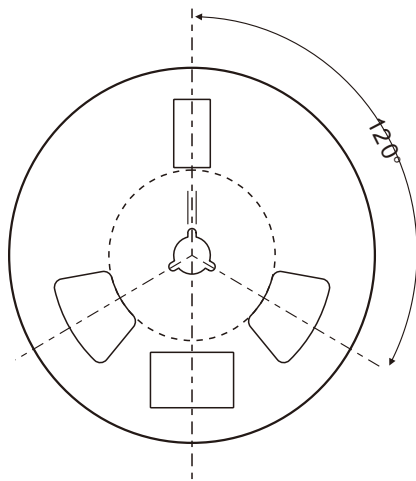
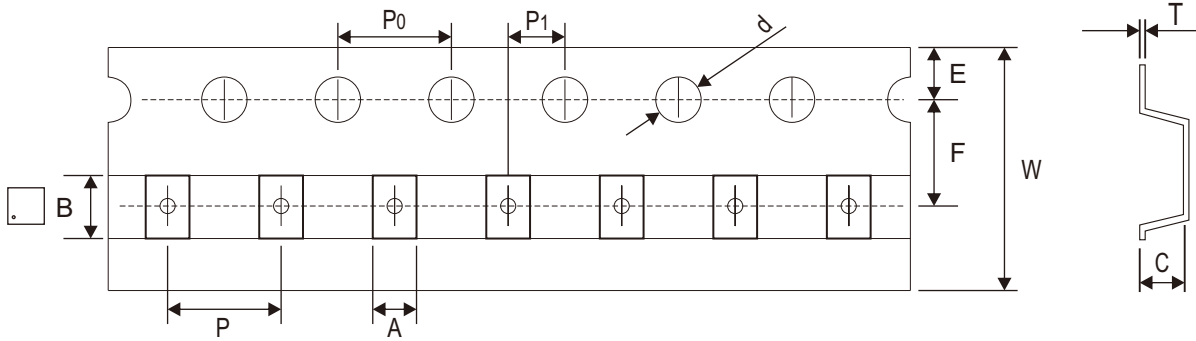

	SYMBOL	A	B	C	d	D	D1	D2
CSPB1515-4	(mm)	1.65 ± 0.05	1.65 ± 0.05	0.50 ± 0.05	1.50 + 0.10 - 0.00	180.00 Typ	60.00 Typ	13.00 Typ
	(inch)	0.065 ± 0.002	0.065 ± 0.002	0.020 ± 0.002	0.059 + 0.004 - 0.000	7.087 Typ	2.362 Typ	0.512 Typ

	SYMBOL	E	F	P	P0	P1	T	W	W1
CSPB1515-4	(mm)	1.75 ± 0.10	3.50 ± 0.05	4.00 Typ	4.00 Typ	2.00 ± 0.05	0.20 ± 0.02	8.00 + 0.30 - 0.10	11.40 Typ
	(inch)	0.069 ± 0.004	0.138 ± 0.002	0.157 Typ	0.157 Typ	0.079 ± 0.002	0.008 ± 0.001	0.315 + 0.012 - 0.004	0.449 Typ

Company reserves the right to improve product design, functions and reliability without notice. REV:A

## Marking Code

Part Number	Marking Code
CMSBN4615-HF	4615

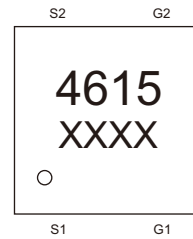

XXXX = Control code

## Suggested PAD Layout

SIZE	CSPB1515-4	
	(mm)	(inch)
A	0.65	0.026
B	0.65	0.026
C	0.30	0.012

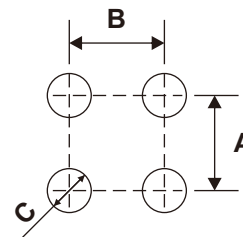

Note: 1. The pad layout is for reference purposes only.

## Standard Packaging

Case Type	REEL PACK	
	REEL ( pcs )	Reel Size (inch)
CSPB1515-4	3000	7