

LFK - 3R LOUVER KIT FILTER

BUL87351
REV. A

ASSEMBLY INSTRUCTIONS FOR
1481L3R SERIES RETROFIT KIT

PARTS LIST

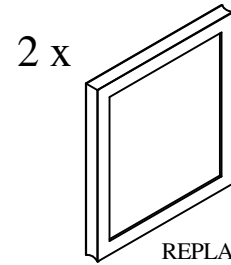
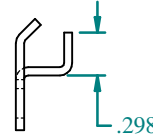
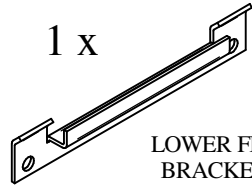
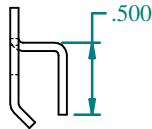
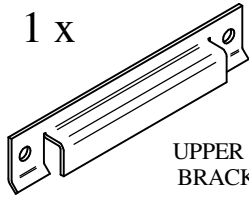

Step 1:

-Remove the keps nuts which hold the current filter brackets in place.

Step 2:

-Remove the old filter brackets and discard.

Step 3:

-Remove the remaining keps nuts which hold the louver plate to the enclosure body, set aside for use in next step.

Step 4:

-Slide the replacement brackets onto the louver plate studs as shown in Figure 1, and secure with keps nuts from previous step.

Step 5:

-Insert the new filter into the upper bracket (1) first, then drop down into the lower bracket (2) as shown in Figure 2.

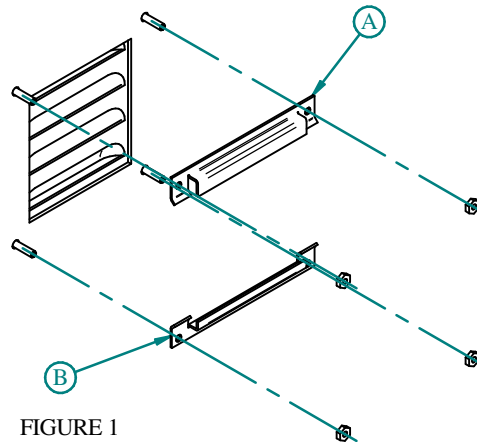

FIGURE 1

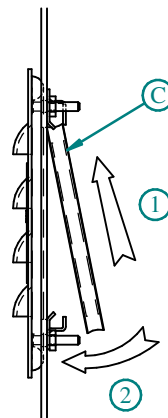
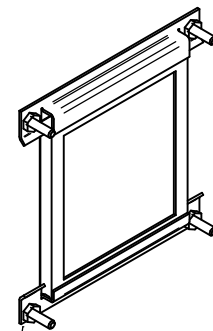
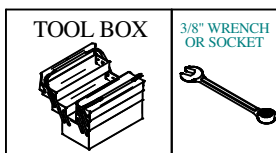

FIGURE 2



COMPLETED ASSEMBLY



 **HAMMOND
MANUFACTURING™**
www.hammondmfg.com