

Middle Power LED Series
3030

LM301Z
CRI 70

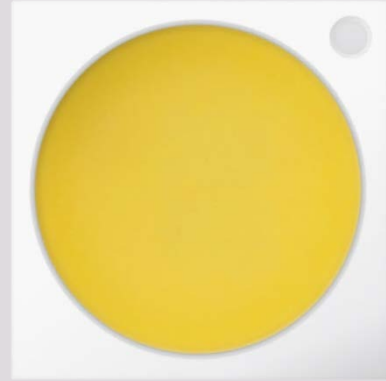

Features & Benefits

- 0.3 W class middle power LED
- EMC resin for high reliability
- Standard form factor for design flexibility (3.0 × 3.0 mm)



Table of Contents

1.	Characteristics	-----	3
2.	Product Code Information	-----	4
3.	Typical Characteristics Graphs	-----	11
4.	Outline Drawing & Dimension	-----	13
5.	Reliability Test Items & Conditions	-----	14
6.	Soldering Conditions	-----	15
7.	Tape & Reel	-----	16
8.	Label Structure	-----	18
9.	Packing Structure	-----	19
10.	Precautions in Handling & Use	-----	22

1. Characteristics

a) Absolute Maximum Rating

Item	Symbol	Rating	Unit	Condition
Ambient / Operating Temperature	T_a	-40 ~ +85	°C	-
Storage Temperature	T_{stg}	-40 ~ +100	°C	-
LED Junction Temperature	T_j	125	°C	-
Forward Current	I_F	400	mA	-
Pulse Forward Current	I_{FP}	600	mA	Duty 1/10, pulse width 10 ms
Assembly Process Temperature	-	260 <10	°C s	-
ESD (HBM)	-	5	kV	-

b) Electro-optical Characteristics ($I_F = 65 \text{ mA}$, $T_s = 25 \text{ °C}$)

Item	Nominal CCT (K)	Rank	Bin	Min.	Typ.	Max.	Unit
Forward Voltage (V_F)		WA	AY	2.6	-	2.7	V
			AZ	2.7	-	2.8	
			A1	2.8	-	2.9	
Reverse Voltage (@ 5 mA)				0.7	-	1.2	V
Color Rendering Index (R_a)		3		70	-	-	-
Special CRI (R9)				-	-	-	-
Thermal Resistance (junction to solder point)				-	12	-	°C/W
Beam Angle				-	120	-	°

Note:

Samsung maintains measurement tolerance of: forward voltage = $\pm 0.1 \text{ V}$, luminous flux = $\pm 5 \%$, CRI = ± 3

2. Product Code Information

1	2	3	4	5	6	7	8	9	10	11	12	13	14	15	16	17	18
S	P	M	W	H	3	3	2	6	M	D	3	W	A	V	0	S	A

Digit	PKG Information	Code	Specification												
1 2 3	Samsung Package Middle Power	SPM													
4 5	Color	WH	White												
6	Product Version	3	Zener version												
7 8 9	Form Factor	326	3.0 x 3.0 x 0.65 mm												
10	Sorting Current	M	65 mA												
11	Chromaticity Coordinates	D	MacAdam												
12	CRI	3	Min. 70												
13 14	Forward Voltage (V)	WA	<table border="0"> <tr> <td></td><td>AY</td><td>2.6~2.7</td></tr> <tr> <td>Bin Code:</td><td>AZ</td><td>2.7~2.8</td></tr> <tr> <td></td><td>A1</td><td>2.8~2.9</td></tr> </table>		AY	2.6~2.7	Bin Code:	AZ	2.7~2.8		A1	2.8~2.9			
	AY	2.6~2.7													
Bin Code:	AZ	2.7~2.8													
	A1	2.8~2.9													
15 16	CCT (K)	<table border="0"> <tr> <td>W☆</td><td>3000</td><td>VN, VP, VQ, VR, VS, VT, VU</td></tr> <tr> <td>U☆</td><td>3500</td><td>UN, UP, UQ, UR, US, UT, UU</td></tr> <tr> <td>T☆</td><td>4000</td><td>TN, TP, TQ, TR, TS, TT, TU</td></tr> <tr> <td>R☆</td><td>5000</td><td>RN, RP, RQ, RR, RS, RT, RU</td></tr> </table> <p>☆ : "0" (Whole Bin) "3" (MacAdam 3- step) "Y" (Kitting)</p>	W ☆	3000	VN, VP, VQ, VR, VS, VT, VU	U ☆	3500	UN, UP, UQ, UR, US, UT, UU	T ☆	4000	TN, TP, TQ, TR, TS, TT, TU	R ☆	5000	RN, RP, RQ, RR, RS, RT, RU	
W ☆	3000	VN, VP, VQ, VR, VS, VT, VU													
U ☆	3500	UN, UP, UQ, UR, US, UT, UU													
T ☆	4000	TN, TP, TQ, TR, TS, TT, TU													
R ☆	5000	RN, RP, RQ, RR, RS, RT, RU													
17 18	Luminous Flux (lm)	SA	<table border="0"> <tr> <td>Bin Code:</td><td>SA</td></tr> </table>	Bin Code:	SA										
Bin Code:	SA														

a) Luminous Flux Bins ($I_F = 65 \text{ mA}$, $T_s = 25 \text{ }^\circ\text{C}$)

Nominal CCT (K)	CRI Min.	Product Code	Flux Bin	Flux Range (Φ_v , lm)
3000	70	SPMWH3326MD3WAV☆SA	SA	30.0 – 33.0
3500	70	SPMWH3326MD3WAW☆SA	SA	30.5 – 33.5
4000	70	SPMWH3326MD3WAT☆SA	SA	31.0 – 34.0
5000	70	SPMWH3326MD3WAR☆SA	SA	33.0 – 36.0

Note:

"☆" can be "0" (Whole Bin), "3" (MacAdam 3-step), "Y" (Kitting)

b) Kitting Rule

1) Y Kitting bin Concept

1. Under agreement between customer and SAMSUNG ELECTRONICS, SAMSUNG can supply kitting bin (VF, Color, Im).
2. A forward voltage (VF) of kitting bin is combined by a pair of same VF rank such as (A2+A2) or (A3+A3).
3. A Chromaticity Coordinates of kitting bin is mixed by kitting procedure.(below kitting simulation)

[Kitting example]

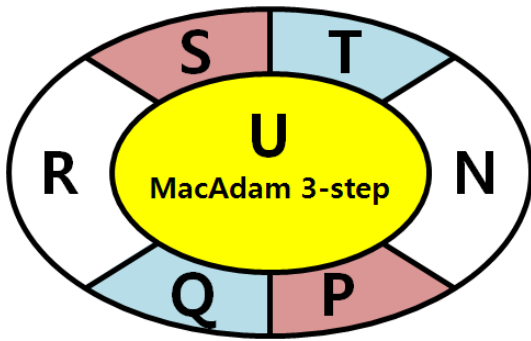

[Binning Information]

	Bin #1	Bin #2
VF	AY	AY
	AZ	AZ
	A1	A1
CIE	U	U
	N	R
	P	S
	Q	T

c) Color Bins (I_F = 65 mA, T_s = 25 °C)

Nominal CCT (K)	CRI	Product Code	Color Rank	Chromaticity Bins
3000	70	SPMWH3326MD3WAV0SA	V0 (Whole Bin)	VN, VP, VQ, VR, VS, VT, VU
		SPMWH3326MD3WAV3SA	V3 (MacAdam 3-step)	VU
		SPMWH3326MD3WAVYSA	VY (Kitting)	VN, VP, VQ, VR, VS, VT, VU
3500	70	SPMWH3326MD3WAU0SA	U0 (Whole Bin)	UN, UP, UQ, UR, US, UT, UU
		SPMWH3326MD3WAU3SA	U3 (MacAdam 3-step)	UU
		SPMWH3326MD3WAUYSA	UY (Kitting)	UN, UP, UQ, UR, US, UT, UU
4000	70	SPMWH3326MD3WAT0SA	T0 (Whole Bin)	TN, TP, TQ, TR, TS, TT, TU
		SPMWH3326MD3WAT3SA	T3 (MacAdam 3-step)	TU
		SPMWH3326MD3WATYSA	TY (Kitting)	TN, TP, TQ, TR, TS, TT, TU
5000	70	SPMWH3326MD3WAR0SA	R0 (Whole Bin)	RN, RP, RQ, RR, RS, RT, RU
		SPMWH3326MD3WAR3SA	R3 (MacAdam 3-step)	RU
		SPMWH3326MD3WARYSA	RY (Kitting)	RN, RP, RQ, RR, RS, RT, RU

d) Voltage Bins (I_F = 65 mA, T_s = 25 °C)

Nominal CCT (K)	CRI Min.	Product Code	Voltage Rank	Voltage Bin	Voltage Range (V)
-	-	-	WA	AY	2.6 ~ 2.7
-	-	-	WA	AZ	2.7 ~ 2.8
-	-	-	WA	A1	2.8 ~ 2.9

e) Chromaticity Region & Coordinates ($I_f = 65 \text{ mA}$, $T_s = 25 \text{ }^\circ\text{C}$)

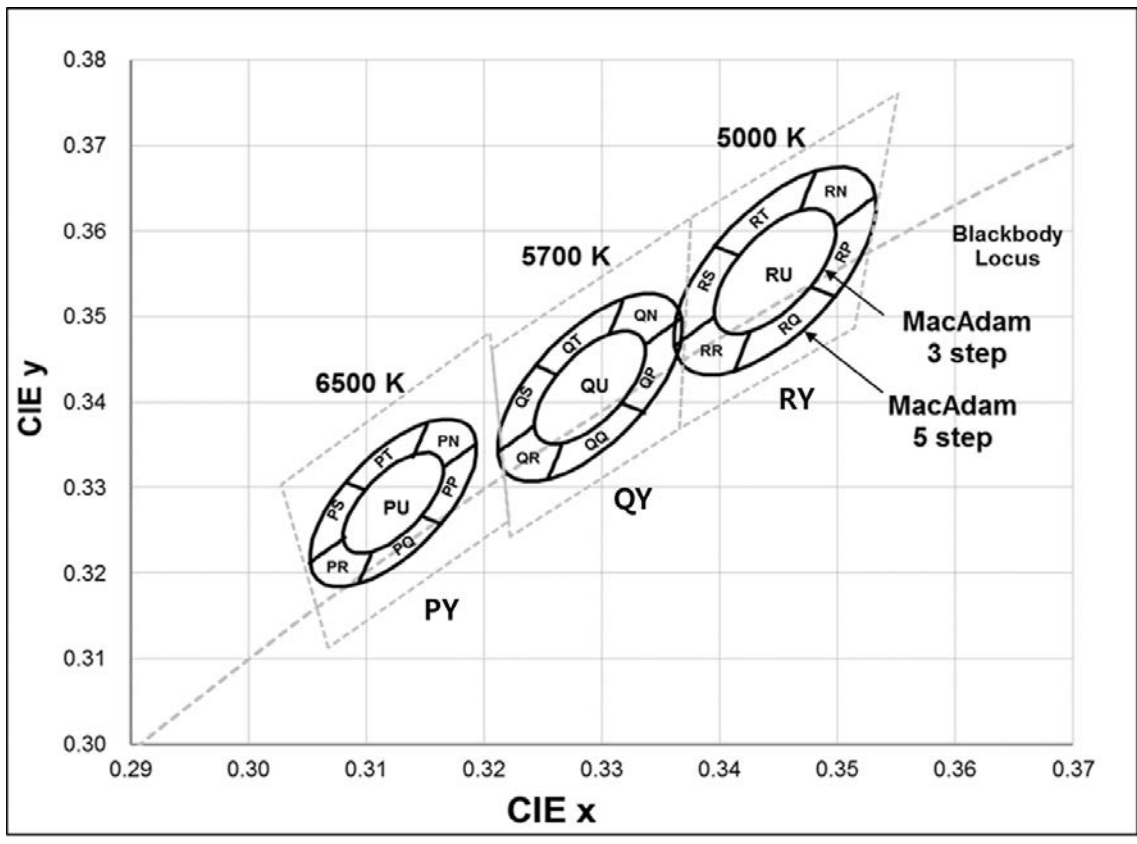
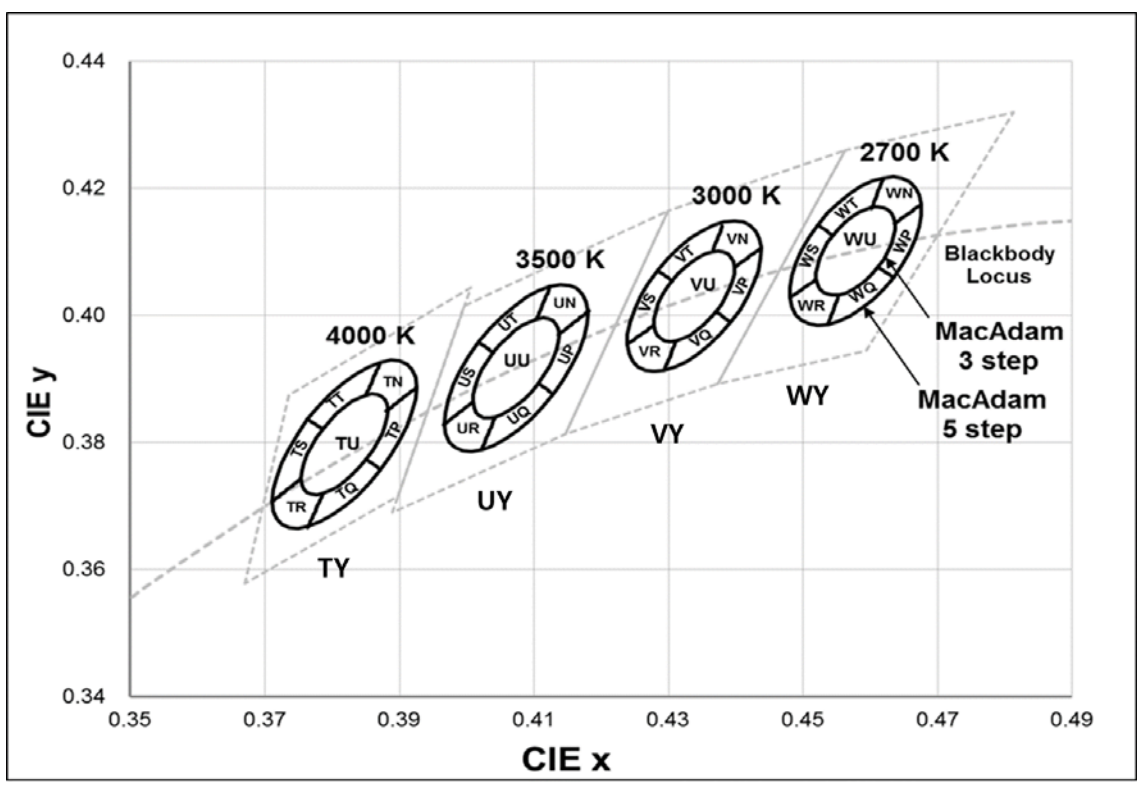

f) Chromaticity Region & Coordinates ($I_F = 65 \text{ mA}$, $T_s = 25 \text{ }^\circ\text{C}$)

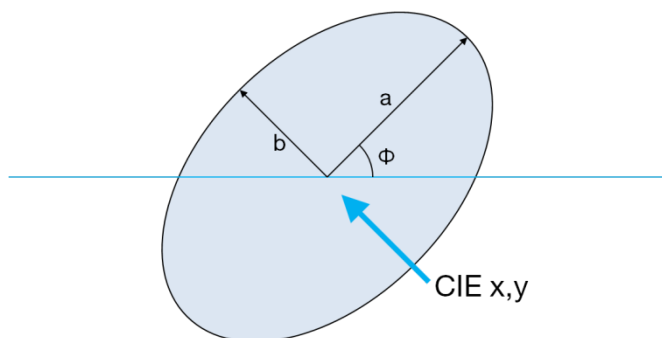

MacAdam	CCT (K)	Center point		Major-axis	Minor-axis	Rotation
		CIE x	CIE y	a	b	ϕ
3 step	3000	0.4338	0.4030	0.0083	0.0041	53.22
	3500	0.4073	0.3917	0.0093	0.0041	54.00
	4000	0.3818	0.3797	0.0094	0.0040	53.72
	5000	0.3447	0.3553	0.0082	0.0035	59.62
5 step	3000	0.4338	0.4030	0.0138	0.0068	53.22
	3500	0.4073	0.3917	0.0155	0.0068	54.00
	4000	0.3818	0.3797	0.0157	0.0067	53.72
	5000	0.3447	0.3553	0.0137	0.0058	59.62

Note:

Samsung maintains measurement tolerance of: $C_x, C_y = \pm 0.005$

e) Chromaticity Region & Coordinates

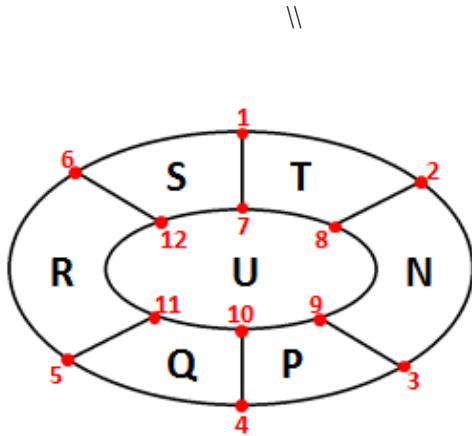

CCT	Region	CIE x	CIE y
3000K	1	0.4283	0.4071
	2	0.4382	0.4146
	3	0.4437	0.4105
	4	0.4393	0.3989
	5	0.4293	0.3913
	6	0.4239	0.3954
	7	0.4305	0.4054
	8	0.4364	0.41
	9	0.4397	0.4075
	10	0.4371	0.4005
	11	0.4311	0.396
	12	0.4279	0.3984

CCT	Region	CIE x	CIE y	CCT	Region	CIE x	CIE y	CCT	Region	CIE x	CIE y
3500K	1	0.4018	0.3957	4000K	1	0.3764	0.3837	5000K	1	0.3397	0.3583
	2	0.4125	0.4046		2	0.3871	0.3926		2	0.3482	0.367
	3	0.418	0.4005		3	0.3925	0.3887		3	0.3532	0.364
	4	0.4128	0.3877		4	0.3872	0.3758		4	0.3497	0.3524
	5	0.4022	0.3788		5	0.3765	0.3668		5	0.3412	0.3436
	6	0.3966	0.3828		6	0.3711	0.3707		6	0.3362	0.3465
	7	0.404	0.3941		7	0.3786	0.3821		7	0.3417	0.3571
	8	0.4104	0.3994		8	0.385	0.3874		8	0.3468	0.3623
	9	0.4137	0.397		9	0.3882	0.3851		9	0.3498	0.3605
	10	0.4106	0.3893		10	0.385	0.3773		10	0.3477	0.3535
	11	0.4042	0.384		11	0.3786	0.372		11	0.3426	0.3483
	12	0.4009	0.3864		12	0.3754	0.3743		12	0.3396	0.35

3. Typical Characteristics Graphs

a) Spectrum Distribution ($I_F = 65 \text{ mA}$, $T_s = 25 \text{ }^\circ\text{C}$)

CCT : 4000K (70 CRI)

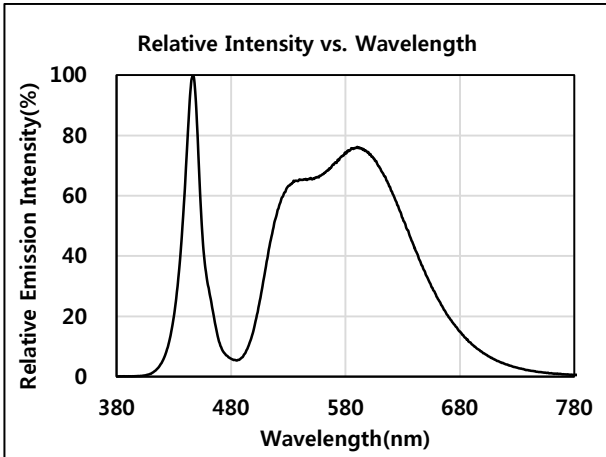

CCT : 5000K (70 CRI)

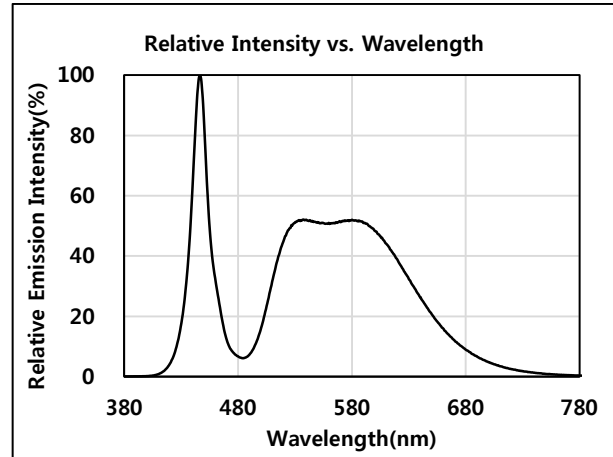

b) Forward Current Characteristics (Ts = 25 °C)

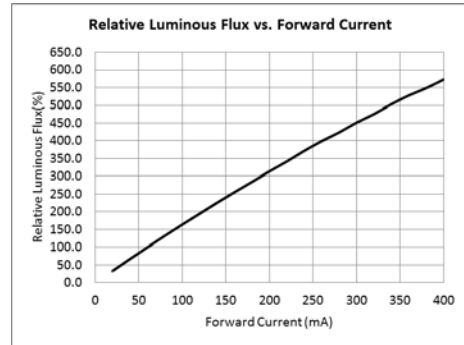
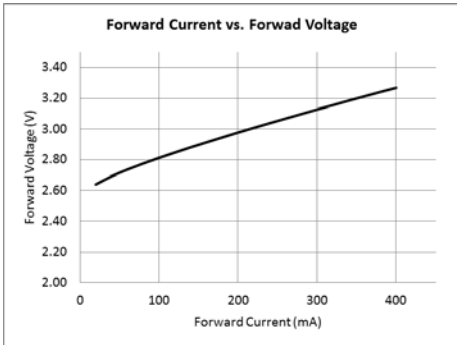

c) Temperature Characteristics (IF = 65 mA)

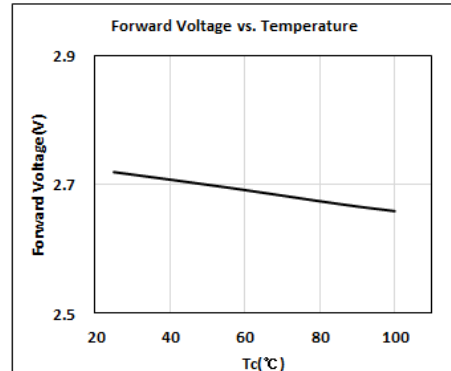
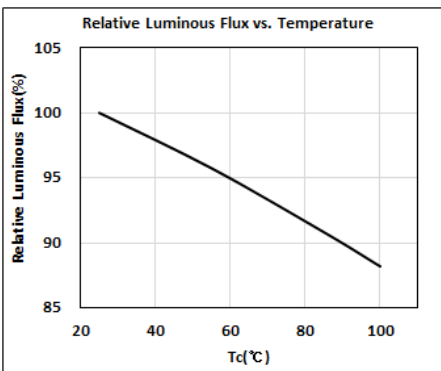

d) Color Shift Characteristics (Ts = 25 °C, IF = 65 mA)

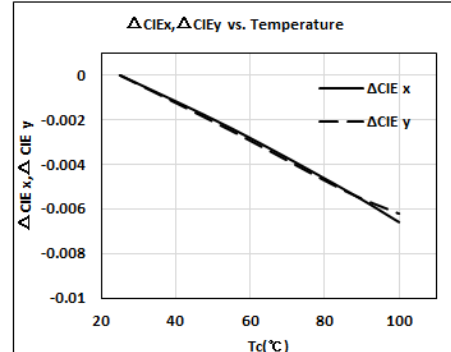
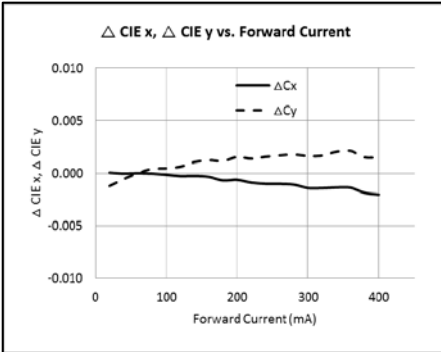

e) Derating Curve

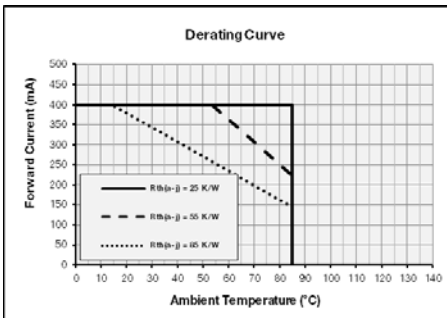

f) Beam Angle Characteristics (IF = 65 mA, Ts = 25 °C)

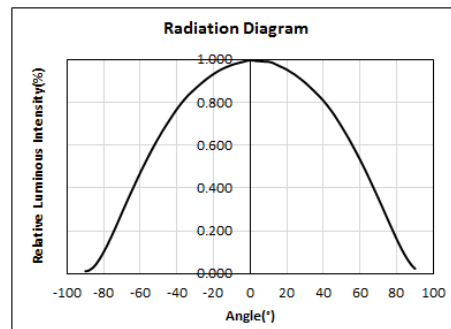

4. Outline Drawing & Dimension

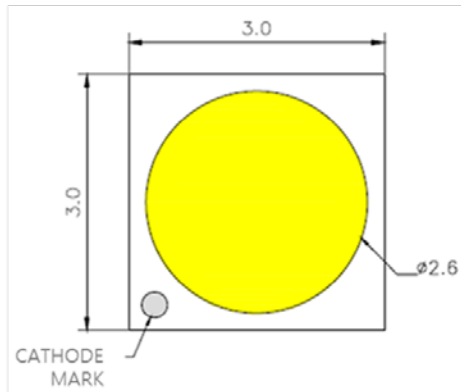

[TOP VIEW]

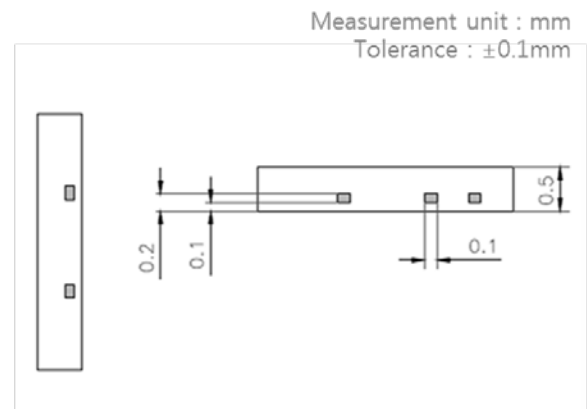

[SIDE VIEW]

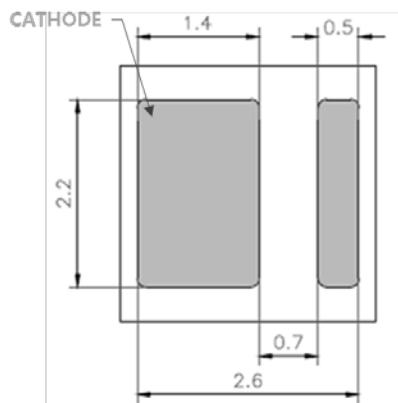

[BOTTOM VIEW]

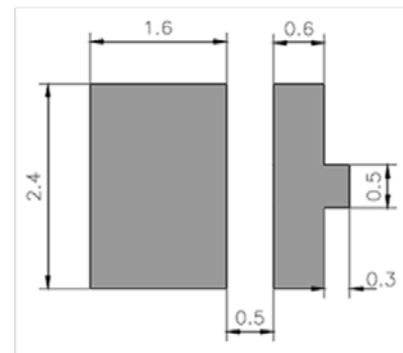

[RECOMMENDED PCB SOLDER PAD]

Notes:

- 1) This LED has built-in ESD protection device(s) connected in parallel to LED chip(s).
- 2) T_s point and measurement method:
 - ① Measure one point at the cathode pad, if necessary remove PSR of PCB to reach T_s point.
 - ② All pads must be soldered to the PCB to dissipate heat properly, otherwise the LED can be damaged.

Precautions:

- 1) Pressure on the LEDs will influence to the reliability of the LEDs. Precautions should be taken to avoid strong pressure on the LEDs. Do not put stress on the LEDs during heating.
- 2) Re-soldering should not be done after the LEDs have been soldered. If re-soldering is unavoidable, LED's characteristics should be carefully checked before and after such repair.

- 3) Do not stack assembled PCBs together. Since materials of LEDs is soft, abrasion between two PCB assembled with LED might cause catastrophic failure of the LEDs.

5. Reliability Test Items & Conditions

a) Test Items

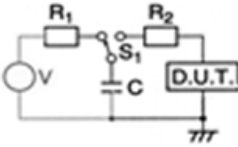
Test Item	Test Condition	Test Hour / Cycle	Sample No.	
Room Temperature Life Test	25 °C, DC 400 mA	1000 h	22	
High Temperature Life Test	85 °C, DC 400 mA	1000 h	22	
High Temperature Humidity Life Test	60 °C, 90 % RH, DC 400 mA	1000 h	22	
Low Temperature Life Test	-40 °C, DC 400 mA	1000 h	22	
Powered Temperature Cycle Test	-45 °C / 20 min ↔ 85 °C / 20 min, sweep 100 min cycle on/off: each 5 min, DC 150 mA	100 cycles	22	
Thermal Cycle	-40 °C / 15 min ↔ 100 °C / 15 min → Hot plate 180 °C	500 cycles	100	
High Temperature Storage	120 °C	1000 h	11	
Low Temperature Storage	-40 °C	1000 h	11	
ESD (HBM)		R_1 : 10 M Ω R_2 : 1.5 k Ω C: 100 pF V: ± 5 kV	5 times	30
		R_1 : 10 M Ω R_2 : 0 C: 200 pF V: ± 0.5 kV	5 times	30
ESD (MM)				
Vibration Test	20~2000~20 Hz, 200 m/s ² , sweep 4 min X, Y, Z 3 direction, each 1 cycle	4 cycles	11	
Mechanical Shock Test	1500 g, 0.5 ms 3 shocks each X-Y-Z axis	5 cycles	11	

b) Criteria for Judging the Damage

Item	Symbol	Test Condition ($T_s = 25$ °C)	Limit	
			Min	Max
Forward Voltage	V_F	$I_F = 65$ mA	Init. Value * 0.9	Init. Value * 1.1
Luminous Flux	Φ_v	$I_F = 65$ mA	Init. Value * 0.7	Init. Value * 1.1

6. Soldering Conditions

a) Reflow Conditions (Pb free)

Reflow frequency: 2 times max.

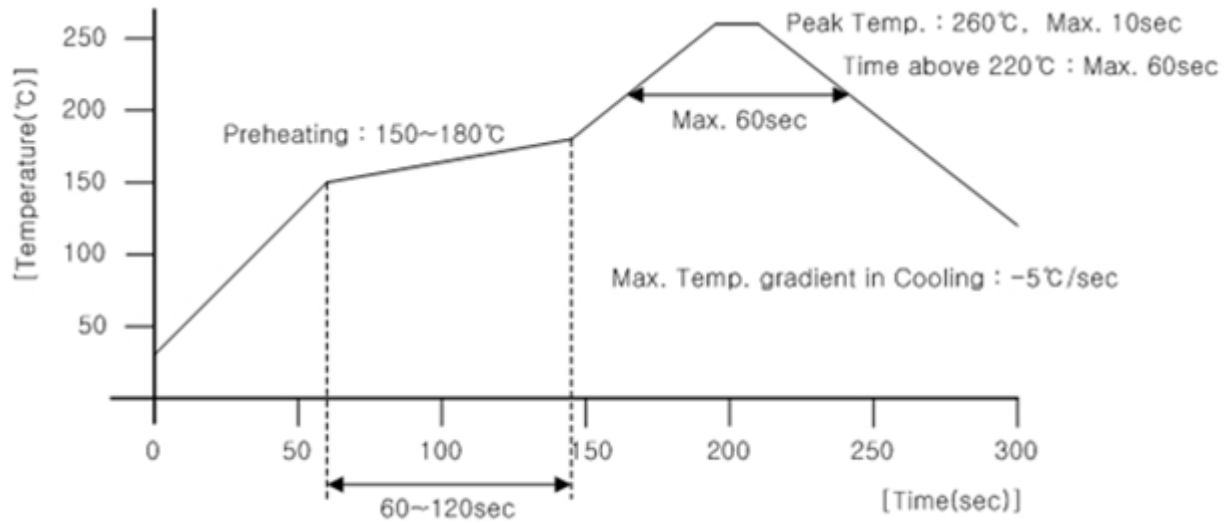

b) Manual Soldering Conditions

Not more than 5 seconds @ max. 300 °C, under soldering iron.

7. Tape & Reel

a) Taping Dimension

(unit: mm)

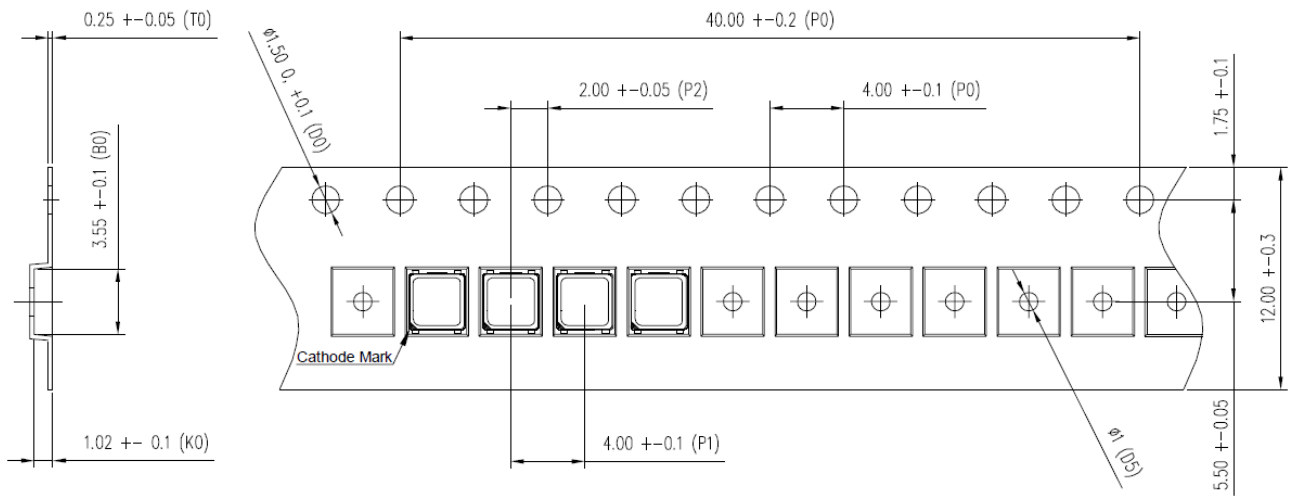

Taping Direction

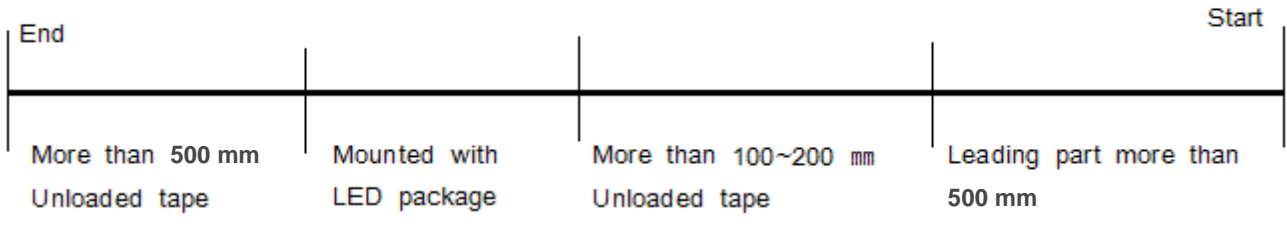
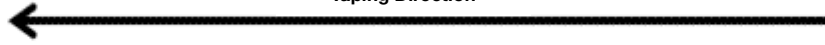

b) Reel Dimension

(unit: mm)

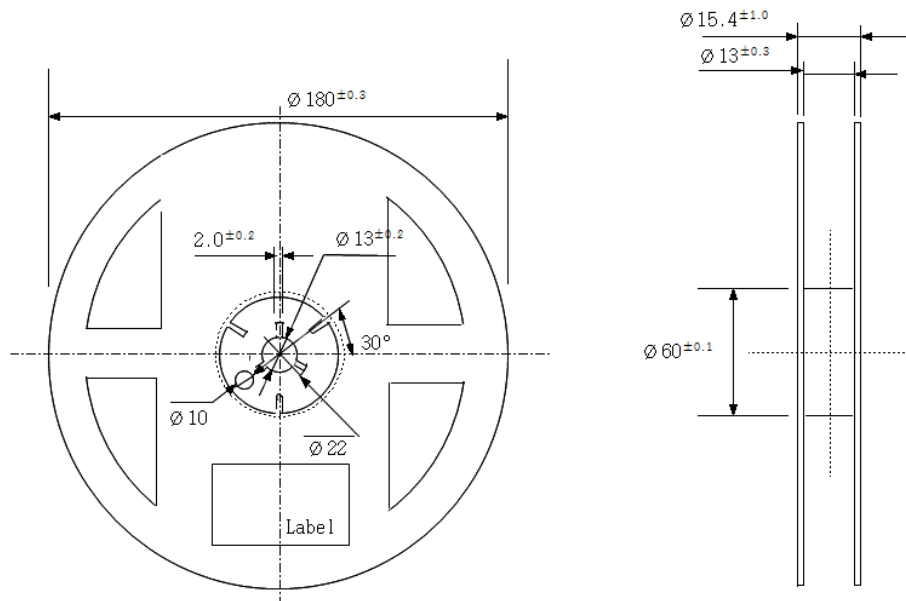
**Notes:**

- 1) Quantity: The quantity/reel is 5,000 pcs
- 2) Cumulative Tolerance: Cumulative tolerance / 10 pitches is ± 0.2 mm
- 3) Adhesion Strength of Cover Tape: Adhesion strength is 0.1-0.7 N when the cover tape is turned off from the carrier tape at 10° angle to the carrier tape
- 4) Packaging: P/N, Manufacturing data code no. and quantity are indicated on the aluminum packing bag

8. Label Structure

a) Label Structure

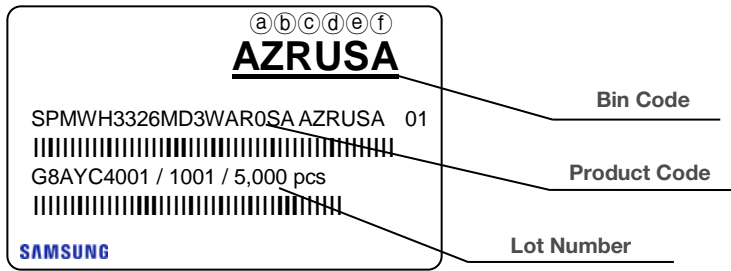

Note: Denoted bin code and product code above is only an example (see description on page 5)

Bin Code:

- ⒶⒷ: Forward Voltage bin (refer to page 8)
- ⒸⒹ: Chromaticity bin (refer to page 10-13)
- ⒺⒻ: Luminous Flux bin (refer to page 8)

b) Lot Number

The lot number is composed of the following characters:

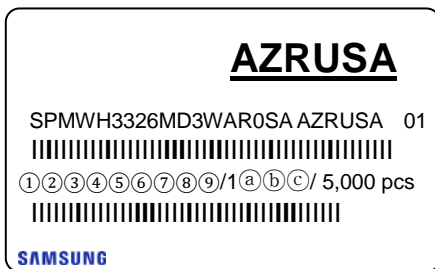

① ②③④⑤⑥⑦⑧⑨ / 1ⒶⒷⒸ / 5,000 pcs

- ① : Production site (S: Giheung, Korea, G: Tianjin, China)
- ② : 8 (LED)
- ③ : Product state (A: Normal, B: Bulk, C: First Production, R: Reproduction, S: Sample)
- ④ : Year (Z: 2015, A: 2016, B: 2017...)
- ⑤ : Month (1~9, A, B, C)
- ⑥⑦⑧⑨ : Day (1~9, A, B~V)
- ⒶⒷⒸ : Product serial number (001 ~ 999)

9. Packing Structure

a) Packing Process (The quantity of PKG on the Reel to be Max 5,000pcs)

Reel

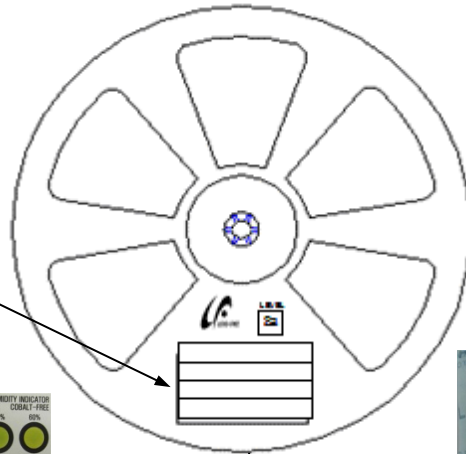
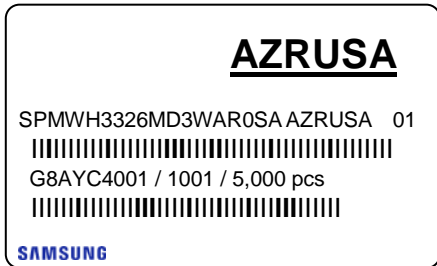

Aluminum Vinyl Packing Bag

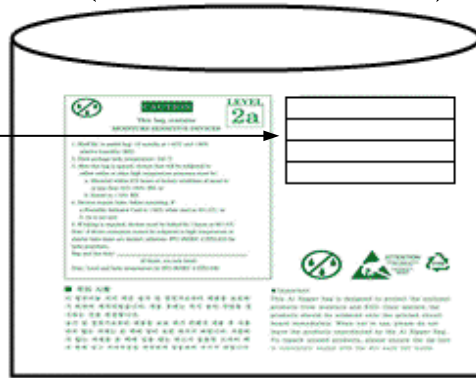
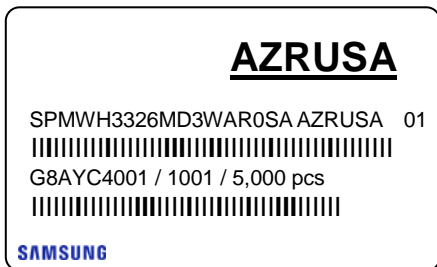

Outer Box

Material: Paper (SW3B(B))

Type	Size (mm)			Note
	L	W	H	
7 inch L	245 ± 5	220 ± 5	182 ± 5	Up to 10 reels
7 inch S	245 ± 5	220 ± 5	86 ± 5	Up to 5 reels

① Side Label

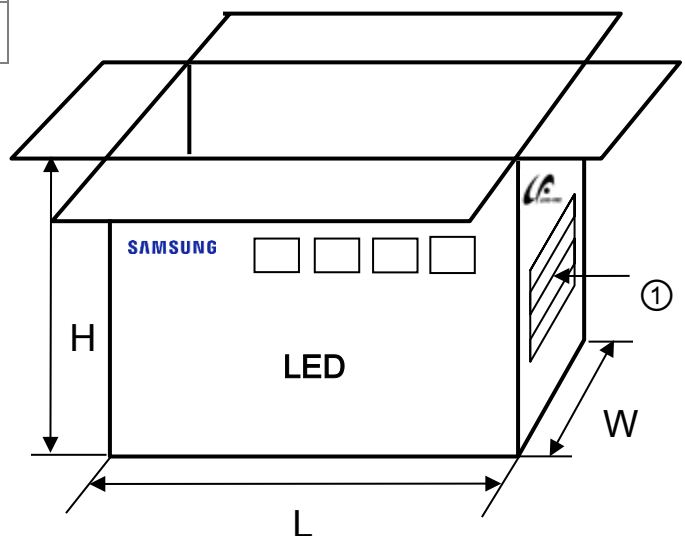
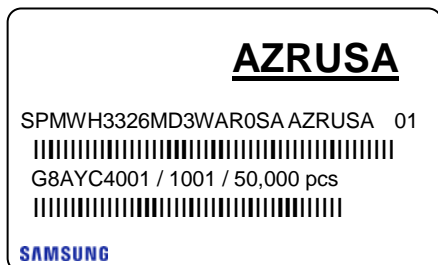

b) Packing Process for kitting (The quantity of PKG on the Reel to be Max 5,000pcs)

Reel

Kitting 'A'

AY★YSA

SPMWH3326MD3WA★YSA AY★YSA 01
 G8AW94001 / 1001 / 5,000 pcs
SAMSUNG

Kitting 'B'

AY★YSA

SPMWH3326MD3WA★YSA AY★YSA 01
 G8AW94001 / 1001 / 5,000 pcs
SAMSUNG

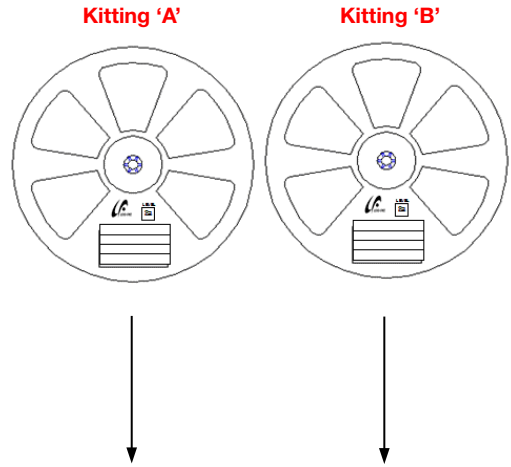

Aluminum Vinyl Packing Bag

Kitting 'A'

AY★YSA

SPMWH3326MD3WA★YSA AY★YSA 01
 G8AW94001 / 1001 / 5,000 pcs
SAMSUNG

Kitting 'B'

AY★YSA

SPMWH3326MD3WA★YSA AY★YSA 01
 G8AW94001 / 1001 / 5,000 pcs
SAMSUNG

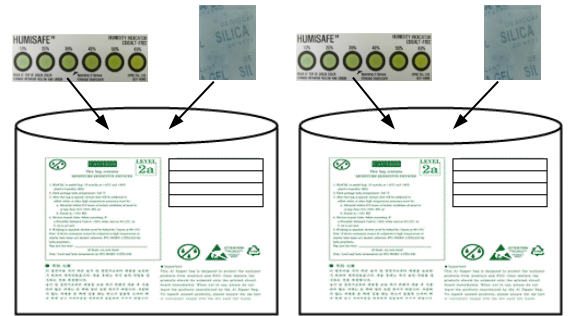

Outer Box

Kitting 'A'

AY★YSA

SPMWH3326MD3WA★YSA AY★YSA 01
 G8AW94001 / 1001 / 50,000 pcs
SAMSUNG [BOX Label]

Kitting 'B'

AY★YSA

SPMWH3326MD3WA★YSA AY★YSA 01
 G8AW94001 / 1001 / 50,000 pcs
SAMSUNG [BOX Label]

Note: "★" can be Nominal CCT code.

Material: Paper (SW3B(B))

Type	Size (mm)			Note
	L	W	H	
7 inch L	245 ± 5	220 ± 5	182 ± 5	Up to 10 reels

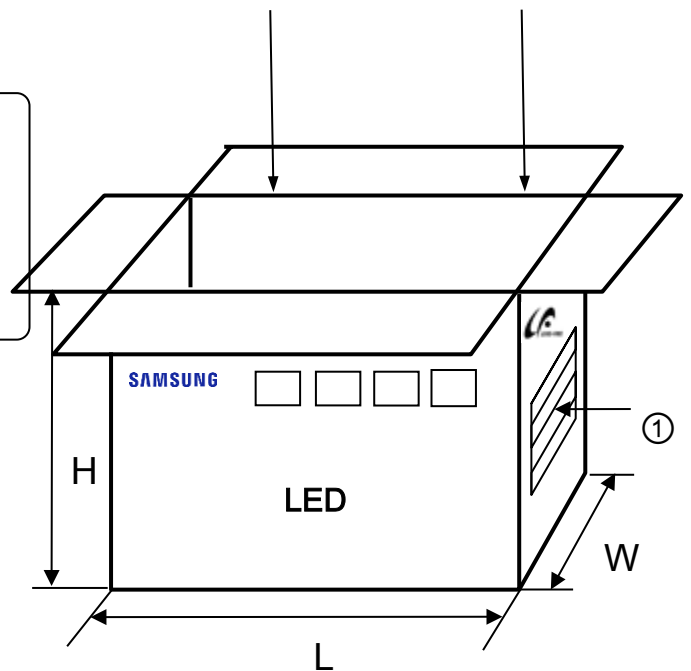

c) Aluminum Vinyl Packing Bag



CAUTION

This bag contains
MOISTURE SENSITIVE DEVICES

LEVEL

2a

1. Shelf life in sealed bag: 12 months at $\lt; 40^{\circ}\text{C}$ and $\lt; 90\%$ relative humidity (RH)
2. Peak package body temperature: 240 °C
3. After this bag is opened, devices that will be subjected to reflow solder or other high temperature processes must be:
 - a. Mounted within 672 hours at factory conditions of equal to or less than $30^{\circ}\text{C} / 60\% \text{ RH}$, or
 - b. Stored at $\lt; 10\% \text{ RH}$
4. Devices require bake, before mounting, if:
 - a. Humidity Indicator Card is $\gt; 60\%$ when read at $23 \pm 5^{\circ}\text{C}$, or
 - b. 2a is not met.
5. If baking is required, devices must be baked for 10 ~ 24 hours at $60 \pm 5^{\circ}\text{C}$

Note: If device containers cannot be subjected to high temperature or shorter bake times are desired, reference IPC/JEDEC J-STD-033 for bake procedure,
Bag seal due date: _____
(If blank, see code label)

Note: Level and body temperature by IPC/JEDEC J-STD-020

AZRUSA

SPMWH3326MD3WAR0SA AZRUSA 01

G8AYC4001 / 1001 / 5,000 pcs

SAMSUNG





ATTENTION

OBSERVE PRECAUTIONS
FOR HANDLING
ELECTROSTATIC
SENSITIVE
DEVICES



■ 주의 사항

이 알루미늄 지퍼 백은 습기 및 정전기로부터 제품을 보호하기 위하여 제작되었습니다. 개봉 후에는 즉시 솔더 작업을 실시하는 것을 권장합니다.

습기 및 정전기로부터 제품을 보호 하기 위해서 개봉 후 사용하지 않는 자재는 본 팩에 넣어 보관 하시기 바랍니다. 사용하지 않는 자재를 본 팩에 넣을 때는 반드시 동봉된 드라이 팩과 함께 넣고 지퍼부분을 완전하게 밀봉하여 주시기 바랍니다.

■ Important

This Al Zipper bag is designed to protect the enclosed products from moisture and ESD. Once opened, the products should be soldered onto the printed circuit board immediately. When not in use, please do not leave the products unprotected by the Al Zipper Bag. To repack unused products., please ensure the zip-lock is completely sealed with the dry pack left inside.

c) Silica Gel & Humidity Indicator Card inside Aluminum Vinyl Bag



10. Precautions in Handling & Use

- 1) For over-current-proof function, customers are recommended to apply resistors to prevent sudden change of the current caused by slight shift of the voltage.
- 2) This device should not be used in any type of fluid such as water, oil, organic solvent, etc. When washing is required, IPA is recommended to use.
- 3) When the LEDs illuminate, operating current should be decided after considering the ambient maximum temperature.
- 4) LEDs must be stored in a clean environment. If the LEDs are to be stored for three months or more after being shipped from Samsung, they should be packed by a sealed container with nitrogen gas injected (shelf life of sealed bags: 12 months, temperature ~40 °C, ~90 % RH).
- 5) After storage bag is opened, device subjected to soldering, solder reflow, or other high temperature processes must be:
 - a. Mounted within 672 hours (28 days) at an assembly line with a condition of no more than 30 °C / 60 % RH, or
 - b. Stored at <10 % RH
- 6) Repack unused products with anti-moisture packing, fold to close any opening and then store in a dry place.
- 7) Devices require baking before mounting, if humidity card reading is >60 % at 23 ± 5 °C.
- 8) Devices must be baked for 10~24 hours at 60 ± 5 °C, if baking is required.
- 9) The LEDs are sensitive to the static electricity and surge. It is recommended to use a wrist band or anti-electrostatic glove when handling the LEDs. If voltage exceeding the absolute maximum rating is applied to LEDs, it may cause damage or even destruction to LED devices. Damaged LEDs may show some unusual characteristics such as increase in leak current, lowered turn-on voltage, or abnormal lighting of LEDs at low current.
- 10) VOCs (Volatile Organic Compounds) can be generated from adhesives, flux, hardener or organic additives used in luminaires (fixtures). Transparent LED silicone encapsulant is permeable to those chemicals and they may lead a discoloration of encapsulant when they exposed to heat or light. This phenomenon can cause a significant loss of light emitted (output) from the luminaires (fixtures). In order to prevent these problems, we recommend users to know the physical properties of the materials used in luminaires, and they must be selected carefully.
- 11) Risk of sulfurization (or tarnishing)

The LED from Samsung Electronics Co., Ltd. uses a silver-plated lead frame and its surface color may change to black (or dark colored) when it is exposed to sulfur (S), chlorine (Cl) or other halogen compound. Sulfurization of lead frame may cause intensity degradation, change of chromaticity coordinates and, in extreme cases, open circuit. It requires caution. Due to possible sulfurization of lead frame, LED should not be used and stored together with oxidizing substances made of materials such as: rubber, plain paper, lead solder cream, etc.

Legal and additional information.

[About Samsung Electronics Co., Ltd.](#)

Samsung inspires the world and shapes the future with transformative ideas and technologies.

The company is redefining the worlds of TVs, smartphones, wearable devices, tablets, digital appliances, network systems, and memory, system LSI, foundry and LED solutions. For the latest news, please visit the Samsung Newsroom at news.samsung.com.

Copyright © 2018 Samsung Electronics Co., Ltd. All rights reserved.

Samsung is a registered trademark of Samsung Electronics Co., Ltd.

Specifications and designs are subject to change without notice. Non-metric weights and measurements are approximate. All data were deemed correct at time of creation. Samsung is not liable for errors or omissions. All brand, product, service names and logos are trademarks and/or registered trademarks of their respective owners and are hereby recognized and acknowledged.

Samsung Electronics Co., Ltd.

95, Samsung 2-ro

Giheung-gu

Yongin-si, Gyeonggi-do, 446-711

KOREA

www.samsungled.com

SAMSUNG