

Data sheet | Item number: 279-915/281-410

Component terminal block; 2-conductor; with diode 1N4007; anode, left side; for DIN-rail 35 x 15 and 35 x 7.5; 1.5 mm²; CAGE CLAMP®; 1,50 mm²; gray

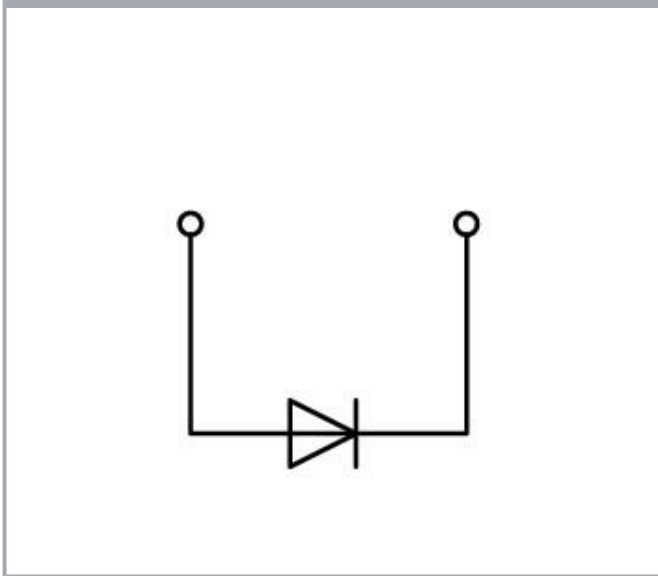

www.wago.com/279-915/281-410

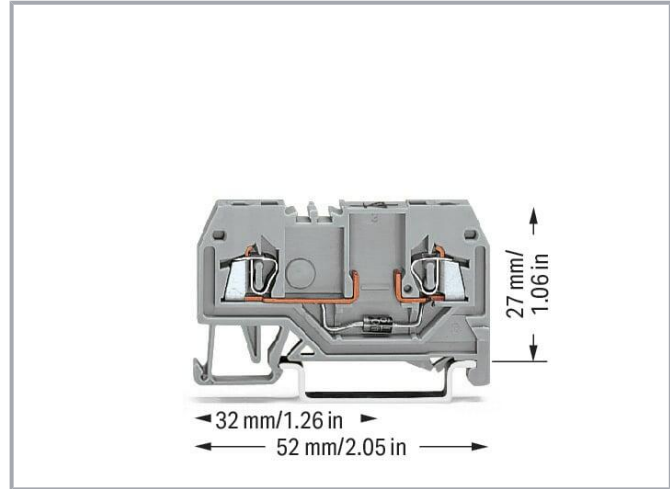
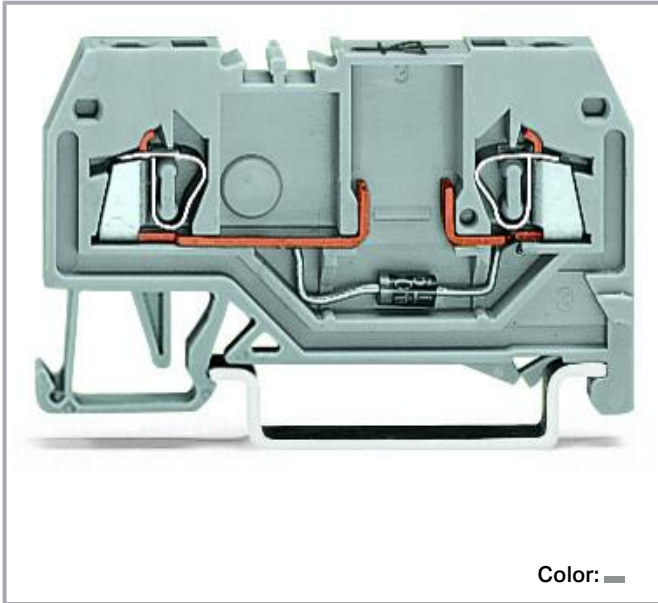

Data
Electrical data

Subject to changes. Please also observe the further product documentation!

WAGO GmbH & Co. KG
Hansastr. 27
32423 Minden
Phone: +49571 887-0 | Fax: +49571 887-169
Email: info.de@wago.com | Web: www.wago.com

Do you have any questions about our products?
We are always happy to take your call at +49 (571) 887-44222.



Ratings per IEC/EN

Ratings per	IEC/EN 60947-7-1
Rated current	0.5 A

General

Nominal voltage	250 V
Reverse voltage	1,000 V

Connection data

Connection points	2
Total number of potentials	1
Number of levels	1

Connection 1

Connection technology	CAGE CLAMP®
Actuation type	Operating tool
Connectable conductor materials	Copper
Solid conductor	0.08 ... 1.5 mm ² / 28 ... 16 AWG
Fine-stranded conductor	0.08 ... 1.5 mm ² / 28 ... 16 AWG
Strip length	8 ... 9 mm / 0.31 ... 0.35 inches
Wiring direction	Front-entry wiring

Physical data

Width	4 mm / 0.157 inches
Height	52 mm / 2.047 inches
Depth from upper-edge of DIN-rail	27 mm / 1.063 inches

Mechanical Data

Design	horizontal type
Mounting type	DIN-35 rail
Marking level	Center marking

Material Data

Note (material data)

[Information on material specifications can be found here](#)

Subject to changes. Please also observe the further product documentation!



Color	gray
Material group	I
Insulation material	Polyamide (PA66)
Flammability class per UL94	V0
Fire load	0.099 MJ
Weight	4.7 g

Environmental requirements

Processing temperature	-35 ... +85 °C
Continuous operating temperature	-60 ... +105 °C

Commercial data

Product Group	1 (Rail Mounted Terminal Blocks)
eCl@ss 10.0	27-14-11-27
eCl@ss 9.0	27-14-11-27
ETIM 8.0	EC000903
ETIM 7.0	EC000903
PU (SPU)	100 pcs
Packaging type	box
Country of origin	DE
GTIN	4044918525459
Customs tariff number	85369010000

Environmental Product Compliance

CAS-No.	7439-92-1 79-94-7
REACH Candidate List Substance	2,2',6,6'-tetrabromo-4,4'-isopropylidenediphenol Lead
RoHS Compliance Status	Compliant,With Exemption
RoHS Exemption	6(c) 7(a) 7(c)-I 7(c)-II
SCIP notification number (Austria)	90e5cd3b-1e74-46b6-8a0a-f58f70991418
SCIP notification number (Belgium)	287b0652-37c5-4d5c-a092-9a2fb7b662a4
SCIP notification number (Bulgaria)	64a845bd-1e1c-4feb-8168-d94862601ce5
SCIP notification number (Czech Republic)	ffb9684c-abea-47b8-8794-47a63fc8d50f

Subject to changes. Please also observe the further product documentation!



WAGO GmbH & Co. KG
 Hansastr. 27
 32423 Minden
 Phone: +49571 887-0 | Fax: +49571 887-169
 Email: info.de@wago.com | Web: www.wago.com

Do you have any questions about our products?
 We are always happy to take your call at +49 (571) 887-44222.

SCIP notification number (Denmark)	3bd220ff-0e24-445d-9c72-015825666e44
SCIP notification number (Finland)	b773621c-9d14-4d06-a566-4eaf18574952
SCIP notification number (France)	3a56e79a-88f0-4ed8-9768-78cccf01834
SCIP notification number (Germany)	6d6a51c1-0e04-43a4-a66e-f98375450b41
SCIP notification number (Hungary)	9db3c237-b2f9-4072-9aa6-42dae3e8838c
SCIP notification number (Italy)	acdb363f-a1f5-418f-af93-f88e29256a10
SCIP notification number (Netherlands)	64069b96-e077-4099-a8b3-de66ef278a59
SCIP notification number (Poland)	9b35bb18-7051-4274-8b9f-7bb287af9f7f
SCIP notification number (Romania)	9c904dc5-25c6-4b61-a727-47e13d568fd9
SCIP notification number (Sweden)	4a270667-7970-4574-8e74-c604f6503062







Required accessories

End plate

End plate		
	Item no.: 279-328 End and intermediate plate; 2 mm thick; orange	www.wago.com/279-328
	Item no.: 279-325 End and intermediate plate; 2 mm thick; gray	www.wago.com/279-325

Optional accessories

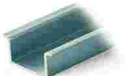
Carrier rail

Mounting accessories		
	Item no.: 210-197 Steel carrier rail; 35 x 15 mm; 1.5 mm thick; 2 m long; slotted; similar to EN 60715; silver-colored	www.wago.com/210-197
	Item no.: 210-198 Copper carrier rail; 35 x 15 mm; 2.3 mm thick; 2 m long; unslotted; according to EN 60715; copper-colored	www.wago.com/210-198
	Item no.: 210-504 Steel carrier rail; 35 x 7.5 mm; 1 mm thick; 2 m long; slotted; galvanized; according to EN 60715; silver-colored	www.wago.com/210-504
	Item no.: 210-505 Steel carrier rail; 35 x 7.5 mm; 1 mm thick; 2 m long; unslotted; galvanized; according to EN 60715; silver-colored	www.wago.com/210-505
	Item no.: 210-506 Steel carrier rail; 35 x 15 mm; 1.5 mm thick; 2 m long; unslotted; galvanized; similar to EN 60715; silver-colored	www.wago.com/210-506
	Item no.: 210-508 Steel carrier rail; 35 x 15 mm; 1.5 mm thick; 2 m long; slotted; galvanized; similar to EN 60715; silver-colored	www.wago.com/210-508

Subject to changes. Please also observe the further product documentation!



Item no.: 210-113

Steel carrier rail; 35 x 7.5 mm; 1 mm thick; 2 m long; unslotted; according to EN 60715; silver-colored

www.wago.com/210-113



Item no.: 210-118

Steel carrier rail; 35 x 15 mm; 2.3 mm thick; 2 m long; unslotted; according to EN 60715; silver-colored

www.wago.com/210-118



Item no.: 210-112

Steel carrier rail; 35 x 7.5 mm; 1 mm thick; 2 m long; slotted; according to EN 60715; "Hole width 25 mm; silver-colored

www.wago.com/210-112



Item no.: 210-114

Steel carrier rail; 35 x 15 mm; 1.5 mm thick; 2 m long; unslotted; similar to EN 60715; silver-colored

www.wago.com/210-114



Item no.: 210-115

Steel carrier rail; 35 x 7.5 mm; 1 mm thick; 2 m long; slotted; according to EN 60715; "Hole width 18 mm; silver-colored

www.wago.com/210-115

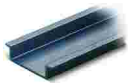

Item no.: 210-196

Aluminum carrier rail; 35 x 8.2 mm; 1.6 mm thick; 2 m long; unslotted; similar to EN 60715; silver-colored

www.wago.com/210-196

Insulation stop

Insulation stop



Item no.: 279-470

Insulation stop; 0.08 - 0.2 mm² "s" (0.14 mm² "f-st"); 5 pieces/strip; white

www.wago.com/279-470



Item no.: 279-471

Insulation stop; 0.25 mm²; 5 pieces/strip; dark gray

www.wago.com/279-471

Tool

Operating tool



Item no.: 210-648

Operating tool; Blade: 2.5 x 0.4 mm; with a partially insulated shaft; angled; short

www.wago.com/210-648



Item no.: 210-647

Operating tool; Blade: 2.5 x 0.4 mm; with a partially insulated shaft; multicoloured

www.wago.com/210-647



Item no.: 210-719

Operating tool; Blade: 2.5 x 0.4 mm; with a partially insulated shaft

www.wago.com/210-719

Mounting

Cover carrier



Item no.: 709-167

Cover carrier; Type 1; incl. fixing/retaining screws and knurled nut; suitable for 279 to 282 and 880 Series rail-mounted terminal blocks; suitable for 264 Series miniature rail-mounted terminal blocks; suitable for 270 Series sensor and actuator terminal blocks; gray

www.wago.com/709-167

Cover

Subject to changes. Please also observe the further product documentation!

WAGO GmbH & Co. KG

Hansastr. 27

32423 Minden

Phone: +49571 887-0 | Fax: +49571 887-169

Email: info.de@wago.com | Web: www.wago.com

Do you have any questions about our products?

We are always happy to take your call at +49 (571) 887-44222.



Item no.: 709-153
Cover; Type 1; suitable for cover carrier, type 1; 1 m long; transparent

www.wago.com/709-153

Mounting accessories



Item no.: 209-106
Mounting carrier; for isolated mounting on DIN 35 rails; gray

www.wago.com/209-106



Item no.: 249-116
Screwless end stop; 6 mm wide; for DIN-rail 35 x 15 and 35 x 7.5; gray

www.wago.com/249-116

Marking accessories

Marker



Item no.: 2009-114/000-002
WMB-Inline; for Smart Printer; 2000 pieces on roll; stretchable 4 - 4.2 mm; plain; snap-on type; yellow

www.wago.com/2009-114/000-002



Item no.: 2009-114/000-005
WMB-Inline; for Smart Printer; 2000 pieces on roll; stretchable 4 - 4.2 mm; plain; snap-on type; red

www.wago.com/2009-114/000-005



Item no.: 2009-114/000-007
WMB-Inline; for Smart Printer; 2000 pieces on roll; stretchable 4 - 4.2 mm; plain; snap-on type; gray

www.wago.com/2009-114/000-007



Item no.: 2009-114/000-023
WMB-Inline; for Smart Printer; 2000 pieces on roll; stretchable 4 - 4.2 mm; plain; snap-on type; green

www.wago.com/2009-114/000-023



Item no.: 2009-114/000-006
WMB-Inline; for Smart Printer; 2000 pieces on roll; stretchable 4 - 4.2 mm; plain; snap-on type; blue

www.wago.com/2009-114/000-006



Item no.: 2009-114/000-024
WMB-Inline; for Smart Printer; 2000 pieces on roll; stretchable 4 - 4.2 mm; plain; snap-on type; violet

www.wago.com/2009-114/000-024



Item no.: 2009-114/000-012
WMB-Inline; for Smart Printer; 2000 pieces on roll; stretchable 4 - 4.2 mm; plain; snap-on type; orange

www.wago.com/2009-114/000-012



Item no.: 2009-114
WMB-Inline; for Smart Printer; 2000 pieces on roll; stretchable 4 - 4.2 mm; plain; snap-on type; white

www.wago.com/2009-114



Item no.: 793-4501/000-002
WMB marking card; as card; stretchable 4 - 4.2 mm; plain; snap-on type; yellow

www.wago.com/793-4501/000-002

Subject to changes. Please also observe the further product documentation!



Item no.: 793-4501/000-006

WMB marking card; as card; stretchable 4 - 4.2 mm; plain; snap-on type; blue

www.wago.com/793-4501/000-006



Item no.: 793-4501/000-014

WMB marking card; as card; stretchable 4 - 4.2 mm; plain; snap-on type; brown

www.wago.com/793-4501/000-014



Item no.: 793-4501

WMB marking card; as card; stretchable 4 - 4.2 mm; plain; snap-on type; white

www.wago.com/793-4501



Item no.: 793-4501/000-023

WMB marking card; as card; stretchable 4 - 4.2 mm; plain; snap-on type; green

www.wago.com/793-4501/000-023



Item no.: 793-4501/000-024

WMB marking card; as card; stretchable 4 - 4.2 mm; plain; snap-on type; violet

www.wago.com/793-4501/000-024



Item no.: 793-4501/000-005

WMB marking card; as card; stretchable 4 - 4.2 mm; plain; snap-on type; red

www.wago.com/793-4501/000-005



Item no.: 793-4501/000-007

WMB marking card; as card; stretchable 4 - 4.2 mm; plain; snap-on type; gray

www.wago.com/793-4501/000-007



Item no.: 793-4501/000-012

WMB marking card; as card; stretchable 4 - 4.2 mm; plain; snap-on type; orange

www.wago.com/793-4501/000-012



Item no.: 793-4501/000-017

WMB marking card; as card; stretchable 4 - 4.2 mm; plain; snap-on type; light green

www.wago.com/793-4501/000-017

Group marker carrier



Item no.: 249-105

Group marker carrier; gray

www.wago.com/249-105

Ferrule

Ferrule



Item no.: 216-101

www.wago.com/216-101

Subject to changes. Please also observe the further product documentation!

WAGO GmbH & Co. KG

Hansastr. 27

32423 Minden

Phone: +49571 887-0 | Fax: +49571 887-169

Email: info.de@wago.com | Web: www.wago.com

Do you have any questions about our products?

We are always happy to take your call at +49 (571) 887-44222.

Ferrule; Sleeve for 0.5 mm² / AWG 22; uninsulated; electro-tin plated; silver-colored

	Item no.: 216-102 Ferrule; Sleeve for 0.75 mm ² / AWG 20; uninsulated; electro-tin plated; silver-colored	www.wago.com/216-102
---	--	--

	Item no.: 216-103 Ferrule; Sleeve for 1 mm ² / AWG 18; uninsulated; electro-tin plated	www.wago.com/216-103
---	---	--

	Item no.: 216-203 Ferrule; Sleeve for 1 mm ² / AWG 18; insulated; electro-tin plated; red	www.wago.com/216-203
---	--	--

	Item no.: 216-202 Ferrule; Sleeve for 0.75 mm ² / 18 AWG; insulated; electro-tin plated; gray	www.wago.com/216-202
---	--	--

	Item no.: 216-201 Ferrule; Sleeve for 0.5 mm ² / 20 AWG; insulated; electro-tin plated; white	www.wago.com/216-201
---	--	--

	Item no.: 216-301 Ferrule; Sleeve for 0.25 mm ² / AWG 24; insulated; electro-tin plated; yellow	www.wago.com/216-301
---	--	--

	Item no.: 216-302 Ferrule; Sleeve for 0.34 mm ² / 22 AWG; insulated; electro-tin plated; light turquoise	www.wago.com/216-302
---	---	--

Jumpers

Jumper

	Item no.: 279-492 Jumper; 2-way; insulated; gray	www.wago.com/279-492
---	--	--

	Item no.: 279-490 Jumper; 10-way; insulated; gray	www.wago.com/279-490
--	---	--

	Item no.: 279-482 Jumper; 2-way; insulated; gray	www.wago.com/279-482
---	--	--

	Item no.: 279-483 Jumper; 3-way; insulated; gray	www.wago.com/279-483
---	--	--

Protective warning marker

Cover

	Item no.: 279-415 Protective warning marker; 5-pole; with high-voltage symbol, black; yellow	www.wago.com/279-415
--	--	--

Downloads

Documentation

Bid Text

279-915/281-410	2019 Feb 19	xml	Download
X81 - Datei		3.3 kB	
279-915/281-410	2017 Apr 10	doc	Download

Subject to changes. Please also observe the further product documentation!



doc - Datei

24.6 kB

Additional Information

Technical Section

pdf

Download

Technical explanations

2.2 MB

CAD/CAE-Data

CAD data

2D/3D Models 279-915/281-410

URL

Download

CAE data

EPLAN Data Portal 279-915/281-410

URL

Download

WSCAD Universe 279-915/281-410

URL

Download

ZUKEN Portal 279-915/281-410

URL

Download

EPLAN Data Portal 279-915/281-410

URL

Download

WSCAD Universe 279-915/281-410

URL

Download

Environmental Product Compliance

Compliance Search

Environmental Product Compliance 279-915/281-410

URL

Download

Component terminal block; 2-conductor; with diode 1N4007; anode, left side; for DIN-rail 35 x 15 and 35 x 7.5; 1.5 mm²; CAGE CLAMP®; 1,50 mm²; gray

Installation Notes

Commoning

Subject to changes. Please also observe the further product documentation!

WAGO GmbH & Co. KG

Hansastr. 27

32423 Minden

Phone: +49571 887-0 | Fax: +49571 887-169

Email: info.de@wago.com | Web: www.wago.com

Do you have any questions about our products?

We are always happy to take your call at +49 (571) 887-44222.

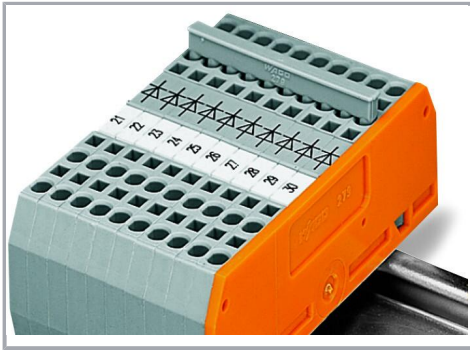

Commoning using comb-style jumper bars:
Push comb-style jumper bars down until fully inserted.

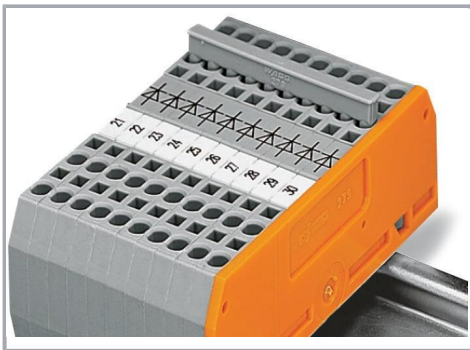

These diode terminal blocks have been specially developed for custom diode circuits, such as lamp test and collective fault signal circuits.

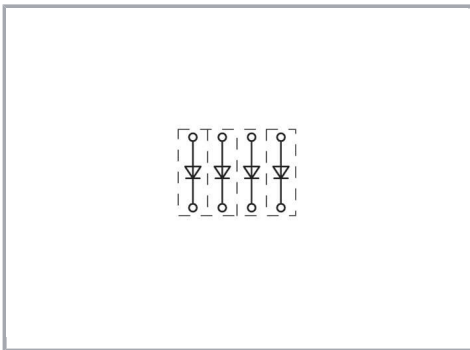

Open diode gates can be created using the following terminal blocks:

279-915/281-410 or 279-915/281-411

Subject to changes. Please also observe the further product documentation!