

Features

- Low forward voltage drop
- Low profile package
- Built-in stain relief, ideal for automatic placement
- Fast switching for high efficiency
- High temperature soldering 250°C/10seconds at terminals
- Plastic material used carries underwriters laboratory classification 94V-0



DO-214AB (SMC)

Absolute Maximum Ratings (T_A=25°C unless otherwise noted)

Parameter	Symbol	HS3A	HS3B	HS3D	HS3F	HS3G	HS3J	HS3K	HS3M	Unit
Maximum Repetitive Peak Reverse Voltage	V _{RRM}	50	100	200	300	400	600	800	1000	V
Maximum RMS Voltage	V _{RMS}	35	70	140	210	280	420	560	700	V
Maximum DC Blocking Voltage	V _{DC}	50	100	200	300	400	600	800	1000	V
Maximum Average Forward Rectified Current	I _{F(AV)}	3.0								A
Peak Forward Surge Current 8.3 ms Single Half Sine-wave Superimposed on Rated Load	I _{FSM}	150								A
Operating Junction Temperature Range	T _J	-55 to +150								°C
Storage Temperature Range	T _{STG}	-55 to +150								°C

Electrical Characteristics (T_A=25°C unless otherwise noted)

Parameter	Symbol	HS3A	HS3B	HS3D	HS3F	HS3G	HS3J	HS3K	HS3M	Unit
Maximum Instantaneous Forward Voltage @3.0A	V _F	1.0				1.3	1.7			V
Typical Junction Capacitance ²	C _J	80					50			pF
Maximum DC Reverse Current at Rated DC Blocking Voltage	I _R (T _A =25°C)	10.0								uA
	I _R (T _A =100°C)	200								uA
Typical Reverse Recovery Time ¹	t _{rr}	50					75			nS

- Notes:** 1. Reverse Recovery Test Conditions: I_F=0.5A, I_R=1.0A, I_{RR}=0.25A
 2. Measured at 1 MHz and Applied V_R=4.0 Volts

Typical Characteristics Curves

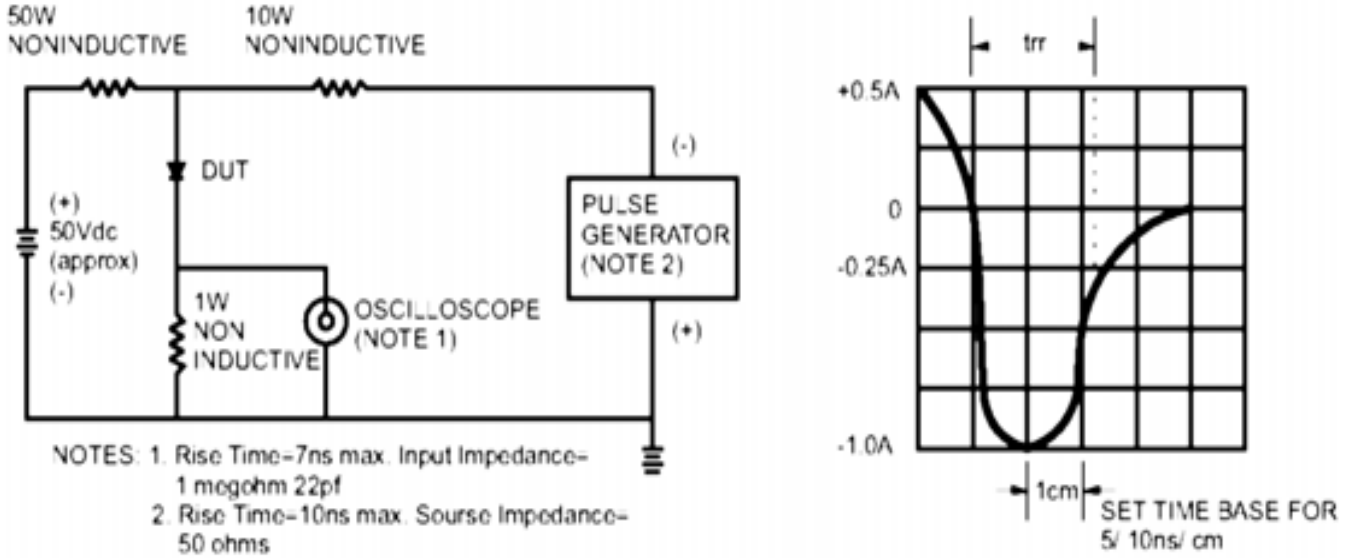

Figure 1. Reverse Recovery Time Characteristic and Test Circuit Diagram

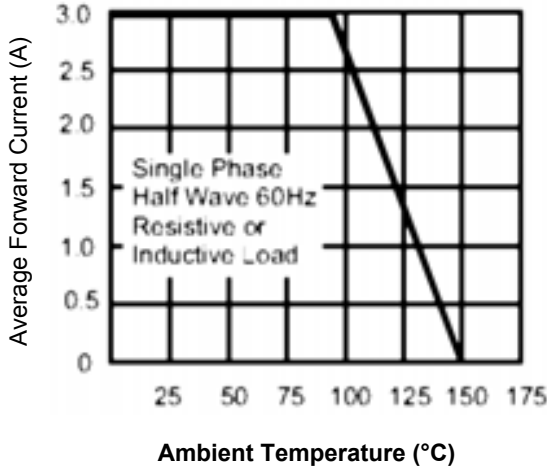

Figure 2. Maximum Forward Current Derating Curve

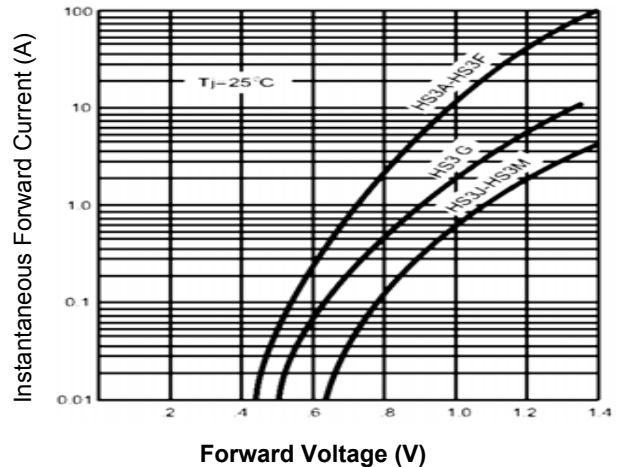

Figure 3. Typical Instantaneous Forward Characteristics

Typical Characteristics Curves

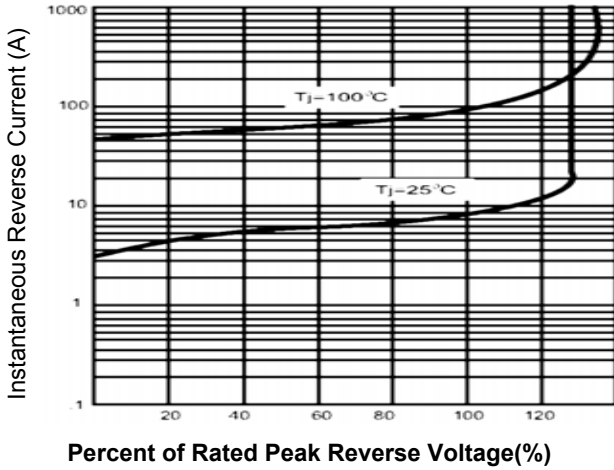

Figure 4. Typical Reverse Characteristics

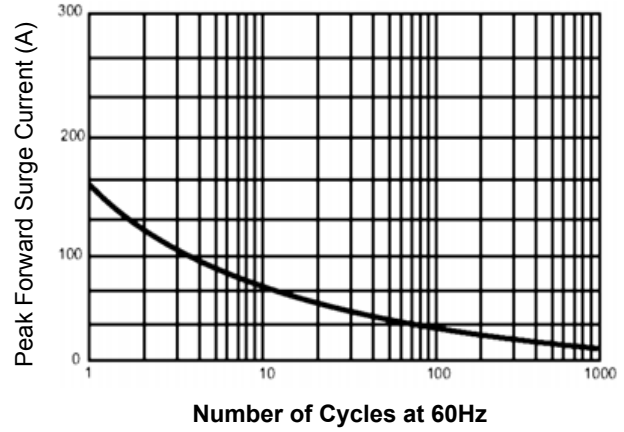

Figure 5. Maximum Non-Repetitive Forward Surge Current

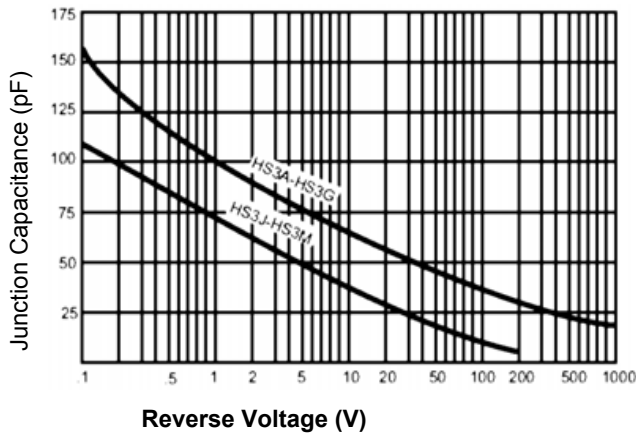
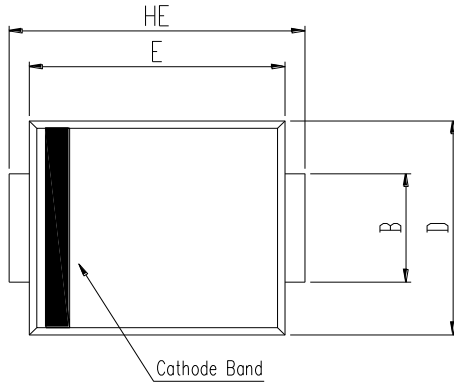
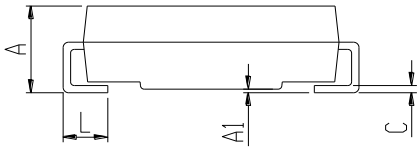

Figure 6. Typical Junction Capacitance

Package Outline Dimensions DO-214AB (SMC)



DIM	SMC (DO-214AB)			
	Millimeters		Inches	
	Min.	Max.	Min.	Max.
A	2.00	2.62	0.079	0.103
A1	0.00	0.20	0.000	0.008
B	2.92	3.07	0.115	0.121
C	0.15	0.31	0.006	0.012
D	5.59	6.22	0.220	0.245
E	6.60	7.11	0.260	0.280
HE	7.75	8.13	0.305	0.320
L	0.76	1.52	0.030	0.060



Recommended Pad Layout

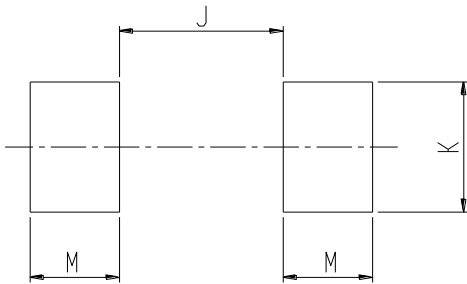

DIM	SMC Recommended Pad Layout (Reference ONLY)			
	Millimeters		Inches	
	Min.	Max.	Min.	Max.
J	-	4.60	-	0.181
K	3.20	-	0.126	-
M	2.00	-	0.079	-