

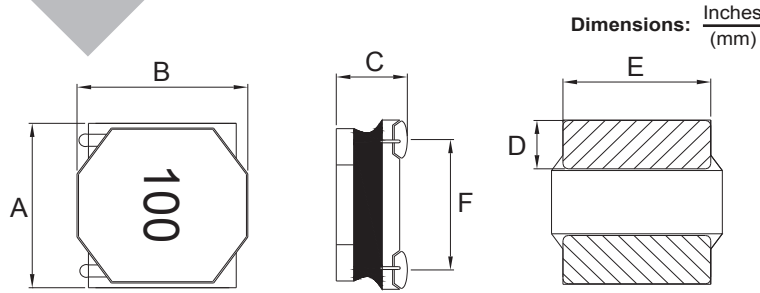

SMD SHIELDED POWER CHIP INDUCTOR

PCHP54NF



A	B	C	D	E	F
.195±.008 (4.95±0.2)	.195±.008 (4.95±0.2)	See Table Below	.051±.012 (1.3±0.3)	.165±.008 (4.2±0.2)	.146 (3.7) Ref



Allied Part Number	Inductance (µH)	Tolerance (%)*	Test Freq. (KHz @1V)	DCR (mΩ) ±20%	I _{rms} (A) Max	I _{sat} (A) Max	Height "C" Dim ±.008(0.2)
PCHP54NF-1R0M-RC	1.0	20	100	12	5.00	7.50	.150(3.8)
PCHP54NF-1R5M-RC	1.5	20	100	15	4.50	6.50	.150(3.8)
PCHP54NF-2R2M-RC	2.2	20	100	21	3.80	5.70	.150(3.8)
PCHP54NF-3R3M-RC	3.3	20	100	24	3.50	4.40	.150(3.8)
PCHP54NF-4R7M-RC	4.7	20	100	32	3.20	3.90	.150(3.8)
PCHP54NF-6R8M-RC	6.8	20	100	43	2.50	3.30	.150(3.8)
PCHP54NF-100M-RC	10	20	100	56	2.20	2.52	.154(3.9)
PCHP54NF-150_*-RC	15	15,20	100	80	1.80	2.00	.154(3.9)
PCHP54NF-220_*-RC	22	15,20	100	123	1.50	1.62	.154(3.9)
PCHP54NF-330_*-RC	33	15,20	100	180	1.20	1.30	.154(3.9)
PCHP54NF-470_*-RC	47	10,20	100	270	1.00	1.10	.154(3.9)
PCHP54NF-680_*-RC	68	10,20	100	400	0.80	0.90	.154(3.9)
PCHP54NF-101_*-RC	100	10,20	100	560	0.72	0.75	.154(3.9)

*Insert letter for desired tolerance: M=20%, L=15%, K=10%
All specifications subject to change without notice.

Recommended Land pattern

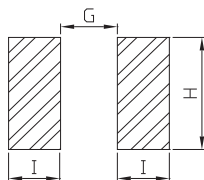

G	H	I
.083 (2.1)	.165 (4.2)	.059 (1.5)

Reflow Solder Profile

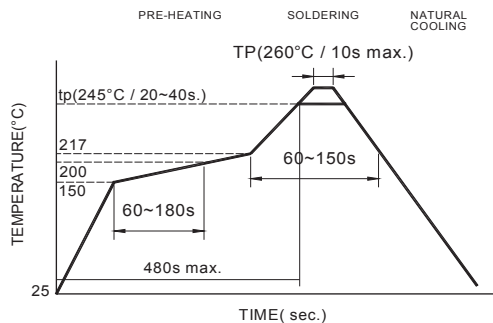

Reflow times: 1 time max.

Features

- Magnetically Shielded
- High Current
- Low DC Resistance

Electrical

Inductance Range: 1.0 - 100µH

Tolerance: 20% 1.0-100µH, 15% 15-33µH, 10% 47-100µH

Operating Temp: -40°C to +125°C

I_{sat}: DC current at which the inductance drops approximately 30% from its value without current.

I_{rms}: DC current that causes the temperature rise (ΔT = 40°C) from 25°C ambient.

Resistance to Soldering Heat

Pre-Heat: 150°C, 1Min

Solder Composition: Sn96.5%, AG3%, Cu0.5%

Temperature: 245±5°C

Flux for Lead Free: Rosin 9.5%

Dip Time: 4±1Sec

Depth: Completely cover the termination

Test Equipment

(L): Agilent 4284A, CH11025, CH3302, CH1320, CH1320S LCR Meter

(DCR): CH502BC Micro-ohmmeter

Physical

Packaging: 1500 per 13" Reel

Marking: EIA Code



Typical Performance Curves

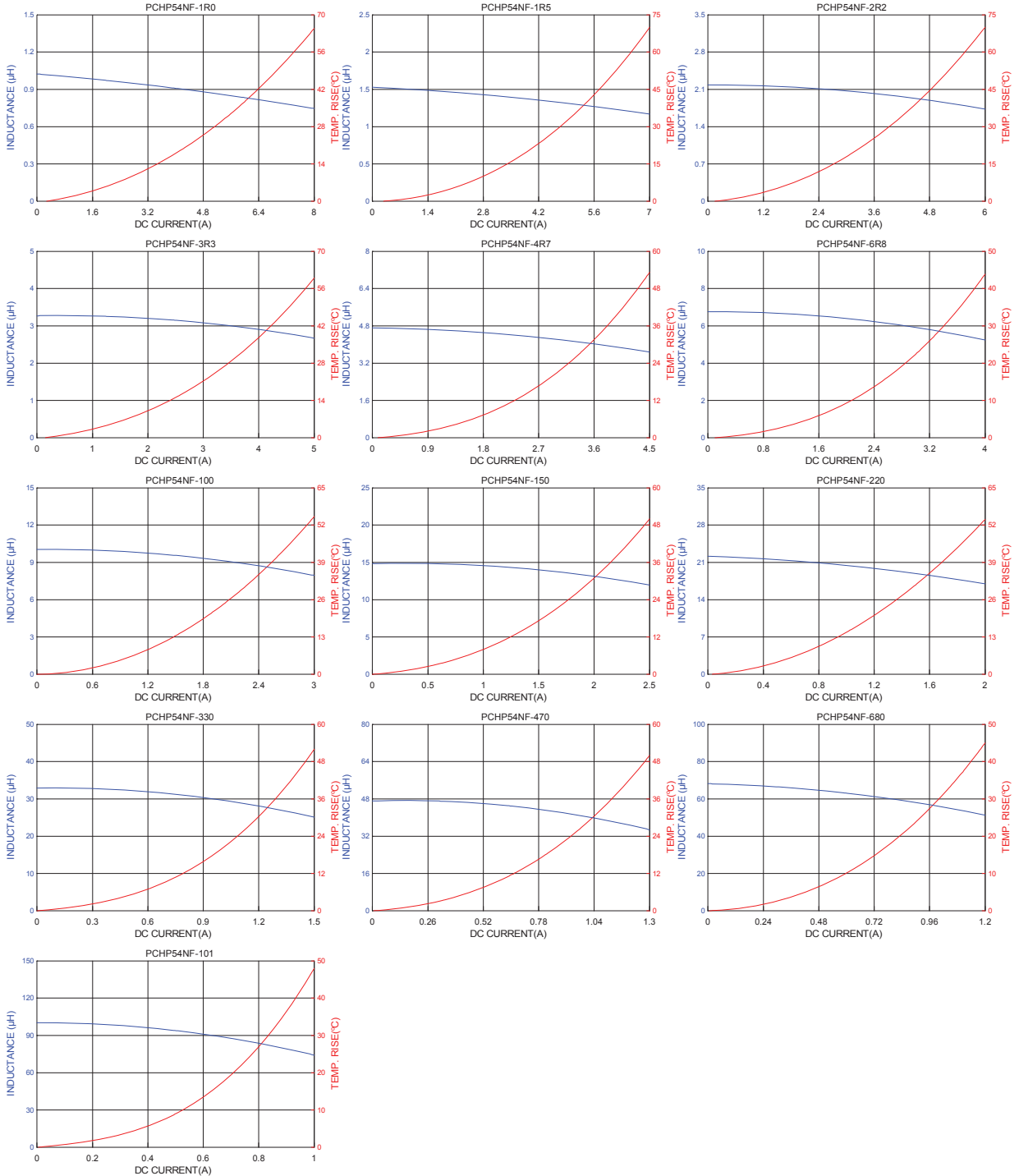



Packaging Information

Reel Dimension

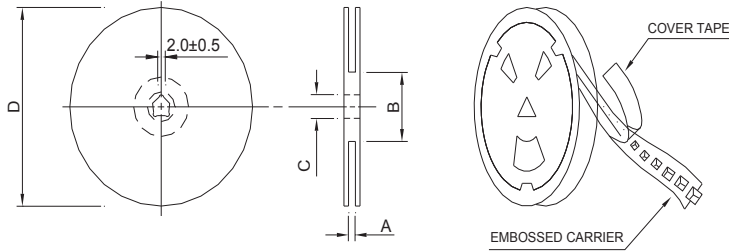

Type	A(mm)	B(mm)	C(mm)	D(mm)
330x12mm	12.4+2/-0	80±2.0	13+0.5/-0.2	330±3.0

Tape Dimension

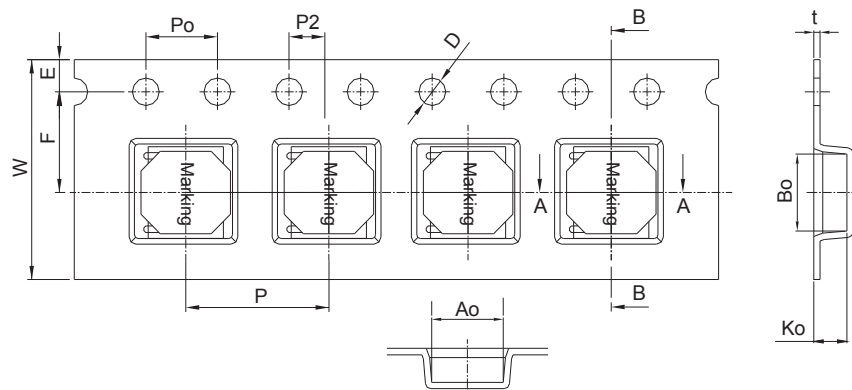

Bo(mm)	Ao(mm)	Ko(mm)	P(mm)	w(mm)	t(mm)	E(mm)	F(mm)	D(mm)	Po(mm)	P2(mm)
5.4±0.1	5.4±0.1	4.3±0.1	8.0±0.1	12±0.3	0.4±0.1	1.75±0.1	7.5±0.1	1.5±0.1	4.0±0.1	2.00±0.1

Tearing Off Force

The force for tearing off cover tape is 10 to 130 grams in the arrow direction under the following conditions(referenced ANSI/EIA-481-C-2003 of 4.11 standard).

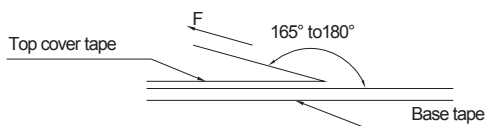

Room Temp. (°C)	Room Humidity (%)	Room atm (hPa)	Tearing Speed mm/min
5~35	45~85	860~1060	300