

**R/A MALE MODULE 6 SOLDER TYPE INSERTS**

**R694.251.117**

**2.5MM FOR PCB**

Series : MCC2

3 Coax Position AB , 1A , 1B , 1C

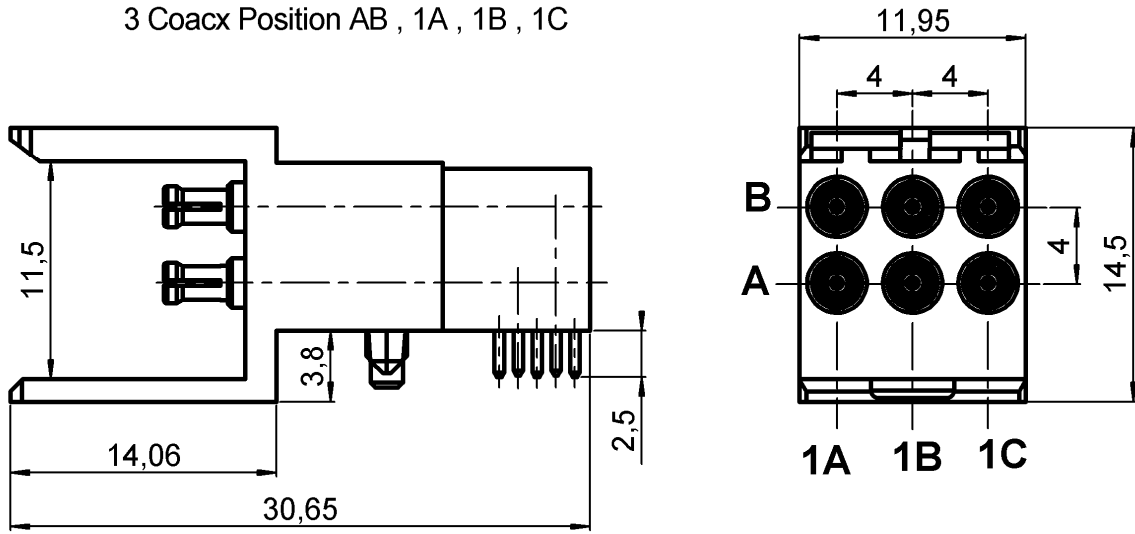

Connectors' packaging

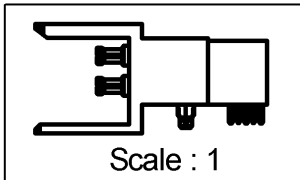
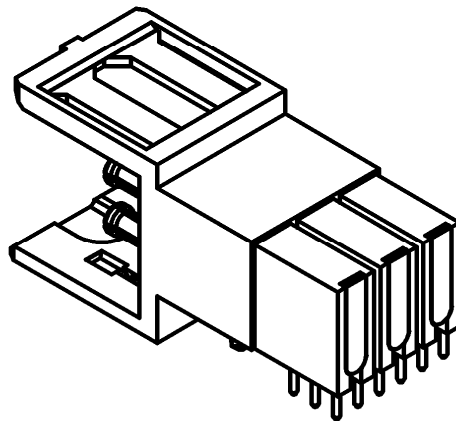
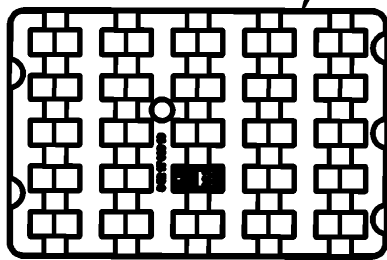

Scale : 1

All dimensions are in mm.

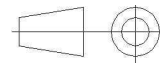

COMPONENTS	MATERIALS	PLATING (µm)
BODY	BRASS	NICKEL 2
CENTER CONTACT	BERYLLIUM COPPER	NPGR
OUTER CONTACT	BRONZE	NPGR
INSULATOR	PEEK , ULTEM	
GASKET	-	
OTHERS PARTS	LIQUID CRYSTAL POLYMER	
.	.	.
.	.	.

Issue : 0818 B

In the effort to improve our products, we reserve the right to make changes judged to be necessary.



**R/A MALE MODULE 6 SOLDER TYPE INSERTS**

**R694.251.117**

**2.5MM FOR PCB**

Series : **MCC2**

**PACKAGING**

**SPECIFICATION**

Standard	Unit	Other
<b>25</b>	<b>'W' option</b>	<b>Contact us</b>

**ELECTRICAL CHARACTERISTICS**

**ENVIRONMENTAL**

Impedance	<b>50</b>	$\Omega$
Frequency	<b>0-6</b>	GHz
VSWR	<b>1.20* + 0,0000</b>	x F(GHz) Maxi
Insertion loss	<b>0.2</b>	$\sqrt{F}$ (GHz) dB Maxi
RF leakage	- (	- F(GHz)) dB Maxi
Voltage rating	<b>500</b>	Veff Maxi
Dielectric withstanding voltage	<b>750</b>	Veff mini
Insulation resistance	<b>5000</b>	M $\Omega$ mini

Operating temperature	<b>-25/+125</b>	$^{\circ}$ C
Hermetic seal	<b>NA</b>	Atm.cm3/s
Panel leakage	<b>NA</b>	

**OTHER CHARACTERISTICS**

Assembly instruction

Others :  
VSWR optimized between DC to 3GHz

**MECHANICAL CHARACTERISTICS**

Center contact retention		
Axial force – Mating end	<b>6</b>	N mini
Axial force – Opposite end	<b>6</b>	N mini
Torque	<b>NA</b>	N.cm mini
Recommended torque		
Mating	<b>NA</b>	N.cm
Panel nut	<b>NA</b>	N.cm
Mating life	<b>500</b>	Cycles mini
Weight	<b>83,5100</b>	g

Issue : 0818 B

In the effort to improve our products, we reserve the right to make changes judged to be necessary.



**R/A MALE MODULE 6 SOLDER TYPE INSERTS**  
**2.5MM FOR PCB**

**R694.251.117**

Series : MCC2

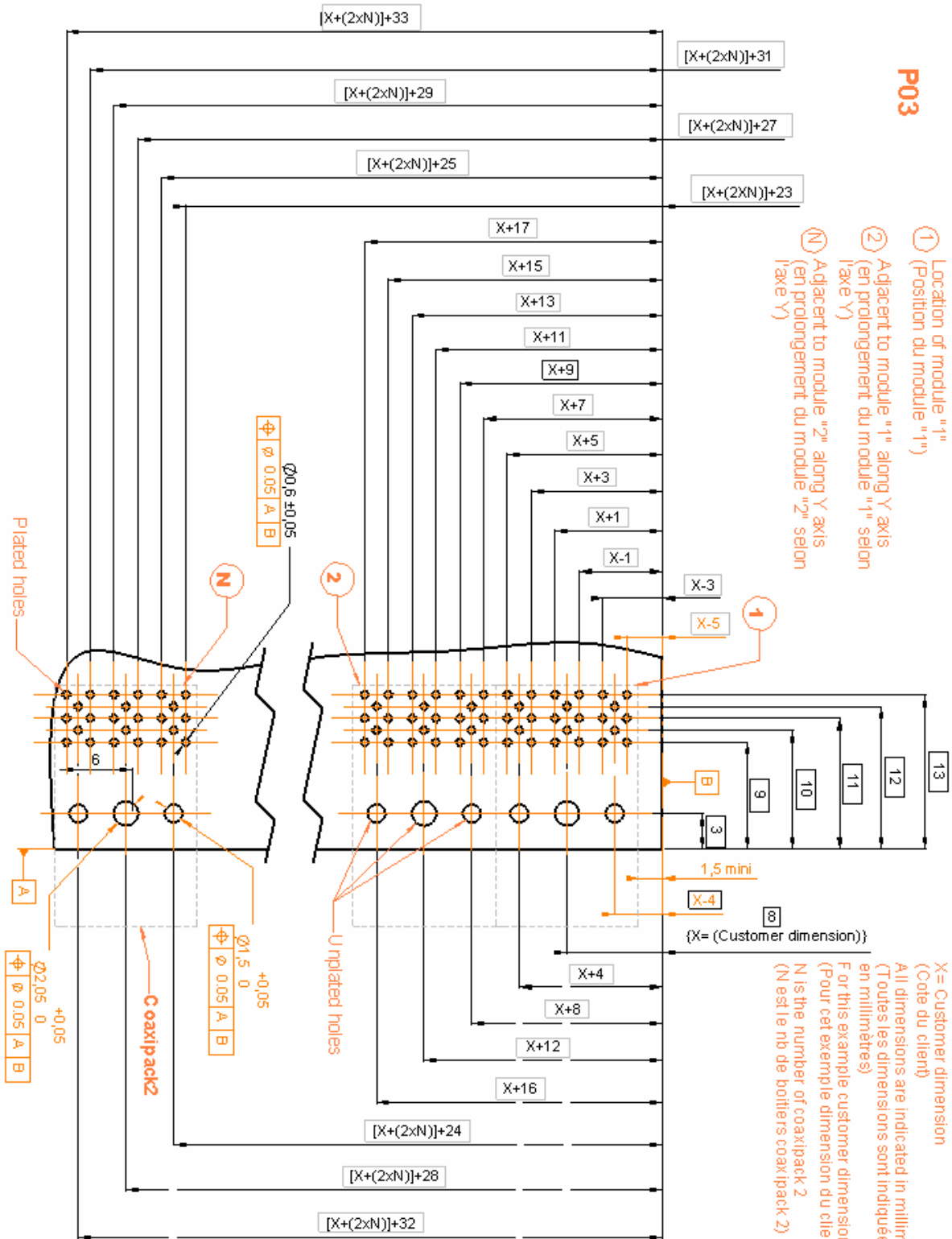

**P03**

- ① Location of module "1" (Position du module "1")
- ② Adjaçent to module "1" along Y axis (en prolongement du module "1" selon l'axe Y)
- Ⓝ Adjaçent to module "2" along Y axis (en prolongement du module "2" selon l'axe Y)

X= Customer dimension (Cote du client)  
 All dimensions are indicated in millimetres (Toutes les dimensions sont indiquées en millimètres)  
 For this example customer dimension X=8mm (Pour cet exemple dimension du client X=8mm)  
 N is the number of coaxial ports (N est le nb de boîtiers coaxipack 2)

Issue : 0818 B

In the effort to improve our products, we reserve the right to make changes judged to be necessary.



**R/A MALE MODULE 6 SOLDER TYPE INSERTS**  
**2.5MM FOR PCB**

**R694.251.117**

Series : MCC2

- Place the coax connector on the PCB

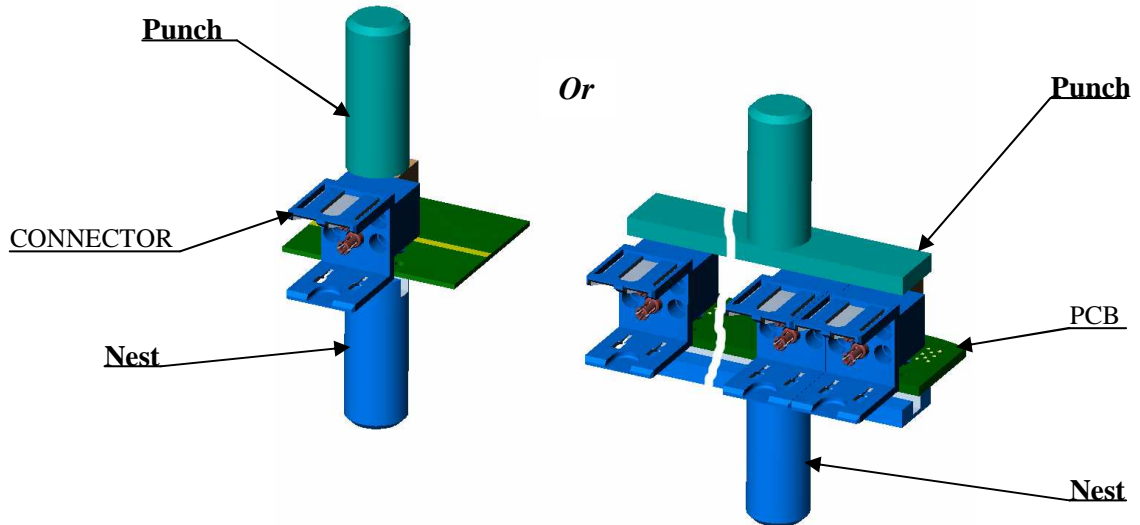

- Place correctly the PCB between the punch and the nest of the press.
- In case of multiple housing configuration , use a punch and a nest large enough to cover all the housings.
- Press on the plastic housing(s) with the punch until the complete insertion of the fixing stud into the PCB.

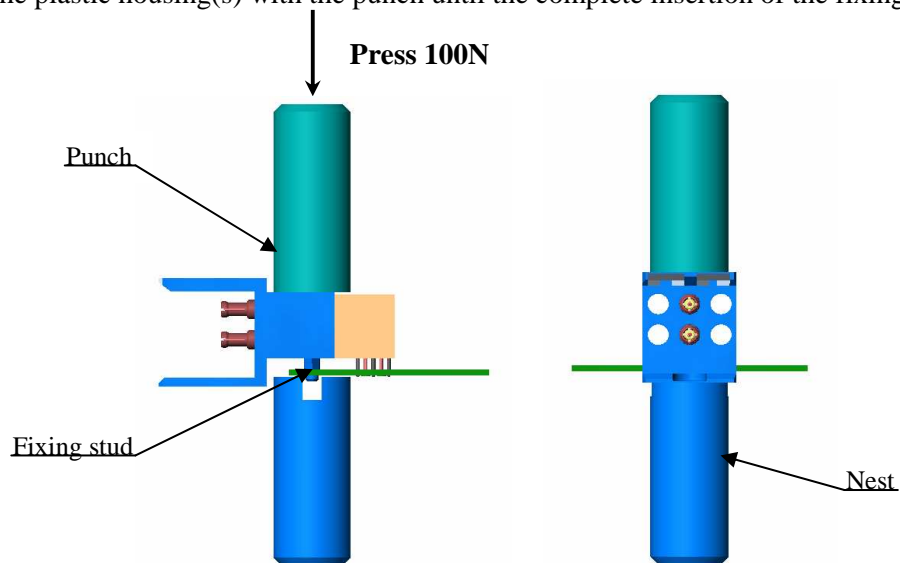

- Solder the legs on board

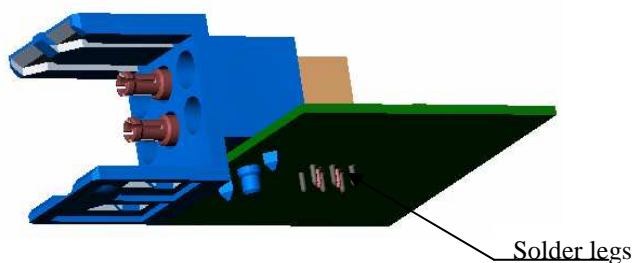

Radiall do not recommend to use more than 3 modules on the same motherboard and can't be held liable of any connection defect when more than 3 modules are implemented on the board

Issue : 0818 B

In the effort to improve our products, we reserve the right to make changes judged to be necessary.

