



LIGHTING FOREVER

Technical Data Sheet

334-15/X2C1-1SUA

Features

- Popular T-1 3/4 round package.
- High luminous power.
- Typical chromaticity coordinates $x=0.40$, $y=0.39$ according to CIE1931.
- Bulk, available taped on reel.
- ESD-withstand voltage: up to 4KV
- The product itself will remain within RoHS compliant version .



Descriptions

- The series is designed for application required high luminous intensity.
- The phosphor filled in the reflector converts the blue emission of InGaN chip to warm white.

Applications

- Message panels
- Optical Indicators
- Backlighting
- Marker Lights

Device Selection Guide

PART NO.	Chip		Lens Color
	Material	Emitted Color	
334-15/X2C1-1SUA	InGaN	Warm White	Water Clear



LIGHTING FOREVER

Technical Data Sheet

334-15/X2C1-1SUA

Absolute Maximum Ratings (Ta=25°C)

Parameter	Symbol	Rating	Unit
Continuous Forward Current	I _F	30	mA
Peak Forward Current(Duty /10 @ 1KHZ)	I _{FP}	100	mA
Reverse Voltage	V _R	5	V
Operating Temperature	T _{opr}	-40 ~ +85	°C
Storage Temperature	T _{stg}	-40 ~ +100	°C
Soldering Temperature (T=5 sec)	T _{sol}	260	°C
Power Dissipation	P _d	110	mW
Zener Reverse Current	I _Z	100	mA
Electrostatic Discharge	ESD	4K	V



LIGHTING FOREVER

Technical Data Sheet

334-15/X2C1-1SUA

Production Designation

334-15/X2C1-□ □ □ □

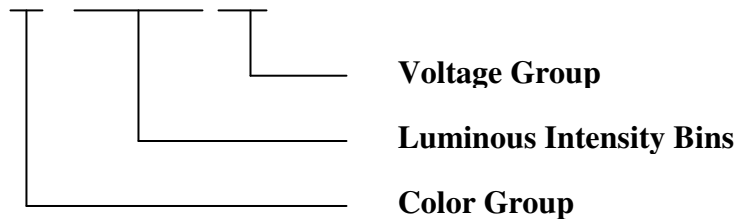

Electro-Optical Characteristics (Ta=25°C)

Parameter	Symbol	Condition	Min.	Typ.	Max.	Units
Forward Voltage	V_F	$I_F=20mA$	2.8	--	3.6	V
Zener Reverse Voltage	V_Z	$I_Z=5mA$	5.2	----	-----	V
Reverse Current	I_R	$V_R=5V$	--	--	50	uA
Luminous Intensity	I_V	$I_F=20mA$	5650	--	11250	mcd
Viewing Angle	$2\theta 1/2$	$I_F=20mA$	--	15	--	deg
Chromaticity Coordinates	x	$I_F=20mA$	--	0.40	--	--
	y		--	0.39	--	--



LIGHTING FOREVER

Technical Data Sheet

334-15/X2C1-1SUA

Luminous Intensity Combination (mcd at 20mA)

Rank	Min	Max
S	5650	7150
T	7150	9000
U	9000	11250

*Measurement Uncertainty of Luminous Intensity: $\pm 10\%$

Forward Voltage Combination (V at 20mA)

Rank	0	1	2	3
Forward Voltage	2.8~3.0	3.0~3.2	3.2~3.4	3.4~3.6

*Measurement Uncertainty of Forward Voltage : $\pm 0.1V$

Color Combination (at 20mA)

Group	Bins
1	D1+D2+E1+E2+F1+F2



LIGHTING FOREVER

Technical Data Sheet

334-15/X2C1-1SUA

CIE Chromaticity Diagram

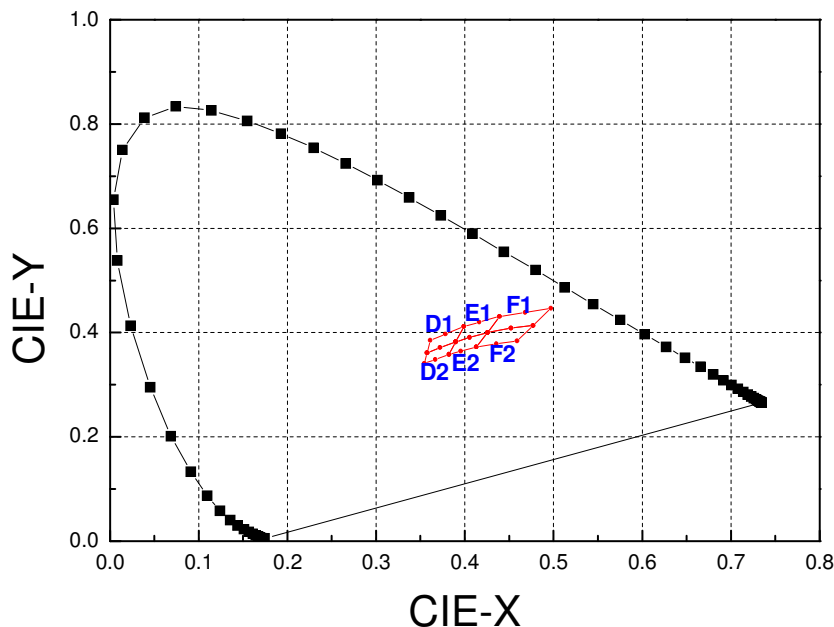

Color Ranks (IF=20mA , Ta=25°C)

Color Ranks		CIE			
D1	X	0.357	0.361	0.398	0.389
	Y	0.361	0.385	0.411	0.382
D2	X	0.354	0.357	0.389	0.382
	Y	0.340	0.361	0.382	0.358
E1	X	0.389	0.398	0.439	0.425
	Y	0.382	0.411	0.431	0.400
E2	X	0.382	0.389	0.425	0.412
	Y	0.358	0.382	0.400	0.372
F1	X	0.425	0.439	0.497	0.477
	Y	0.400	0.431	0.466	0.413
F2	X	0.412	0.425	0.477	0.458
	Y	0.372	0.400	0.413	0.383

*Measurement uncertainty of the color coordinates : ± 0.01



LIGHTING FOREVER

Technical Data Sheet

334-15/X2C1-1SUA

Typical Electro-Optical Characteristics Curves

Relative Intensity vs. Wavelength

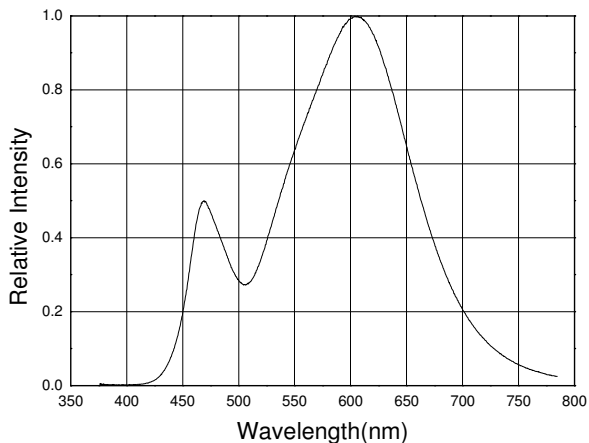

Forward Current vs. Forward Voltage

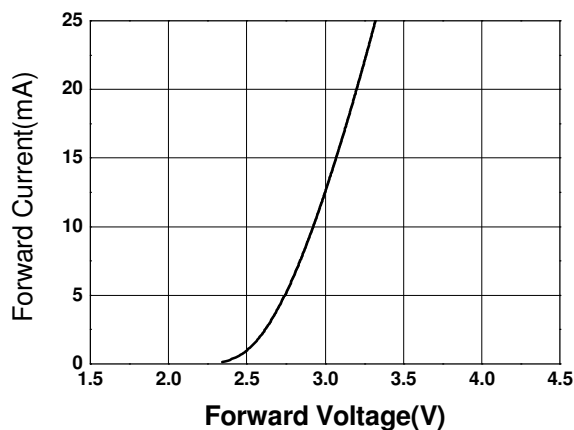

Relative Intensity vs. Forward Current

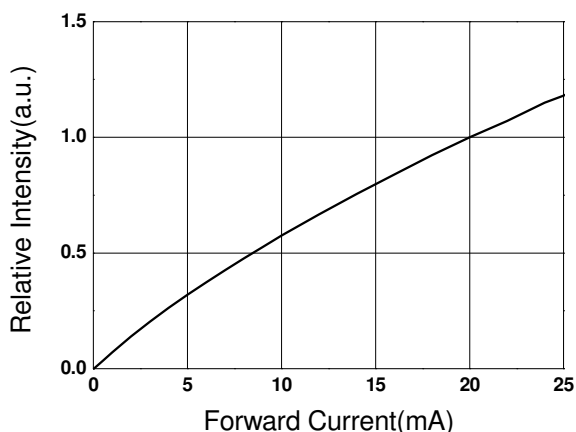

Forward Current vs. Ambient Temp.

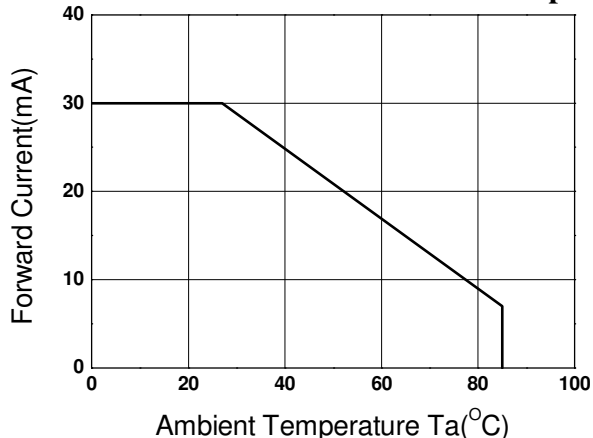

Chromaticity Coordinate vs. Forward Current

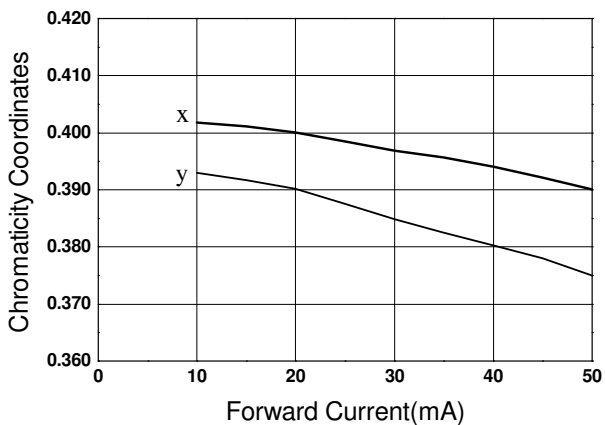

Relative Intensity vs. Angle Displacement

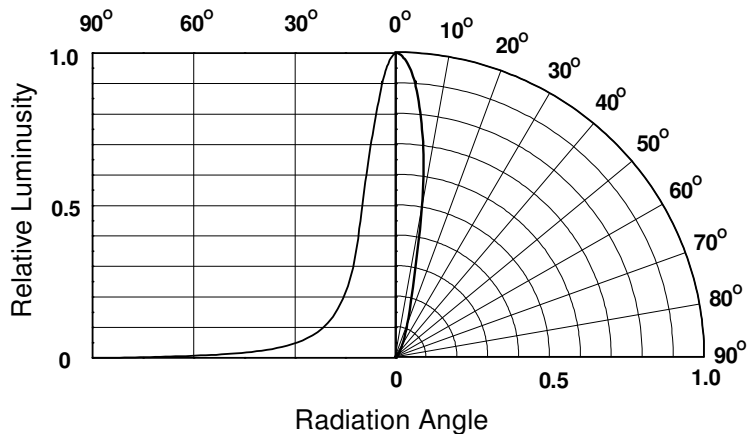



LIGHTING FOREVER

Technical Data Sheet

334-15/X2C1-1SUA

Packing Specification

■ Anti-electrostatic bag

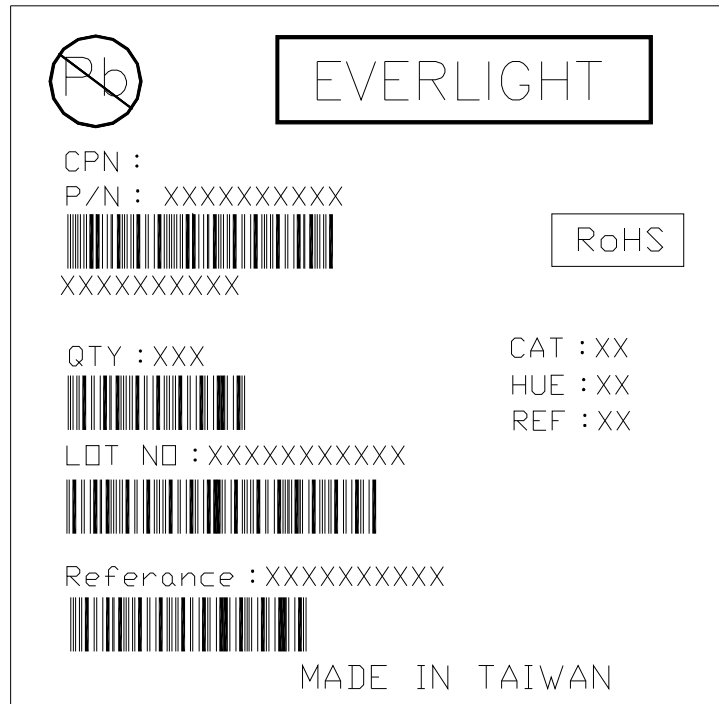
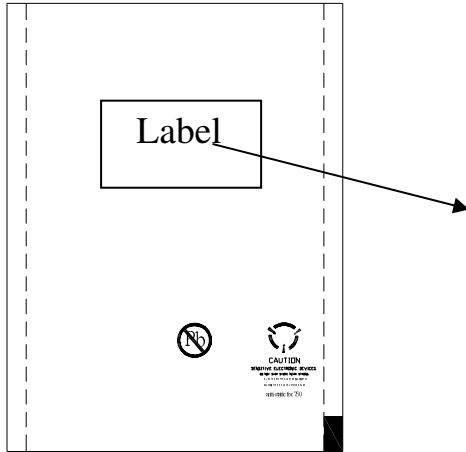

■ Inner Carton

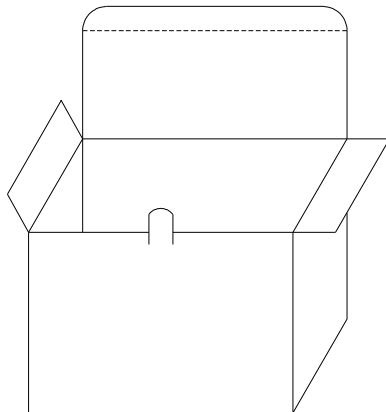

■ Outside Carton

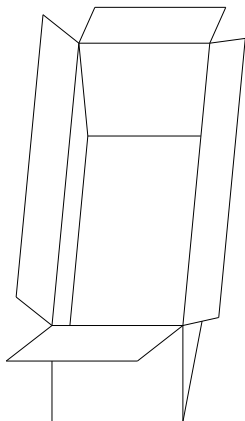

■ Label Form Specification

CPN: Customer's Production Number

P/N : Production Number

QTY: Packing Quantity

CAT: Ranks of Luminous Intensity and Forward Voltage

HUE: Color Rank

REF: Reference

LOT No: Lot Number

MADE IN TAIWAN: Production Place

■ Packing Quantity

1. 500 PCS/1 Bag, 5 Bags/1 Inner Carton

2. 10 Inner Cartons/1 Outside Carton



LIGHTING FOREVER

Technical Data Sheet

334-15/X2C1-1SUA

Notes

1. Lead Forming

- During lead formation, the leads should be bent at a point at least 3mm from the base of the epoxy bulb.
- Lead forming should be done before soldering.
- Avoid stressing the LED package during leads forming. The stress to the base may damage the LED's characteristics or it may break the LEDs.
- Cut the LED leadframes at room temperature. Cutting the leadframes at high temperatures may cause failure of the LEDs.
- When mounting the LEDs onto a PCB, the PCB holes must be aligned exactly with the lead position of the LED. If the LEDs are mounted with stress at the leads, it causes deterioration of the epoxy resin and this will degrade the LEDs.

2. Storage

- The LEDs should be stored at 30°C or less and 70%RH or less after being shipped from Everlight and the storage life limits are 3 months. If the LEDs are stored for 3 months or more, they can be stored for a year in a sealed container with a nitrogen atmosphere and moisture absorbent material.
- Please avoid rapid transitions in ambient temperature, especially, in high humidity environments where condensation can occur.

3. Soldering

- Careful attention should be paid during soldering. When soldering, leave more than 3mm from solder joint to epoxy bulb, and soldering beyond the base of the tie bar is recommended.
- Recommended soldering conditions:

Hand Soldering		DIP Soldering	
Temp. at tip of iron	300°C Max. (30W Max.)	Preheat temp.	100°C Max. (60 sec Max.)
Soldering time	3 sec Max.	Bath temp. & time	260 Max., 5 sec Max
Distance	3mm Min.(From solder joint to epoxy bulb)	Distance	3mm Min. (From solder joint to epoxy bulb)



LIGHTING FOREVER

Technical Data Sheet

334-15/X2C1-1SUA

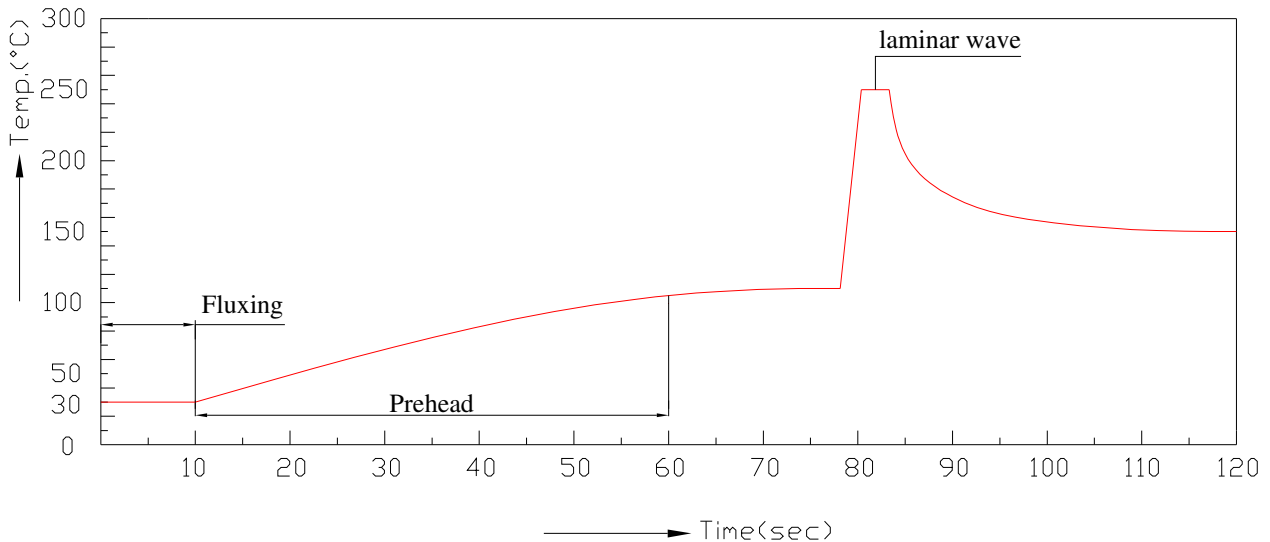

- Avoiding applying any stress to the lead frame while the LEDs are at high temperature particularly when soldering.
- Dip and hand soldering should not be done more than one time
- After soldering the LEDs, the epoxy bulb should be protected from mechanical shock or vibration until the LEDs return to room temperature.
- A rapid-rate process is not recommended for cooling the LEDs down from the peak temperature.
- Although the recommended soldering conditions are specified in the above table, dip or handsoldering at the lowest possible temperature is desirable for the LEDs.
- Wave soldering parameter must be set and maintain according to recommended temperature and dwell time in the solder wave.

4. Cleaning

- When necessary, cleaning should occur only with isopropyl alcohol at room temperature for a duration of no more than one minute. Dry at room temperature before use.
- Do not clean the LEDs by the ultrasonic. When it is absolutely necessary, the influence of ultrasonic cleaning on the LEDs depends on factors such as ultrasonic power and the assembled condition. Ultrasonic cleaning shall be pre-qualified to ensure this will not cause damage to the LED

334-15/X2C1-1SUA

5. Circuit Protection

- Below the zener reference voltage V_z , all the current flows through LED and as the voltage rises to V_z , the zener diode “breakdown.” If the voltage tries to rise above V_z current flows through the zener branch to keep the voltage at exactly V_z .
- When the LED is connected using serial circuit, if either piece of LED is no light up but current can't flow through causing others to light down. In new design, the LED is parallel with zener diode. if either piece of LED is no light up but current can flow through causing others to light up.

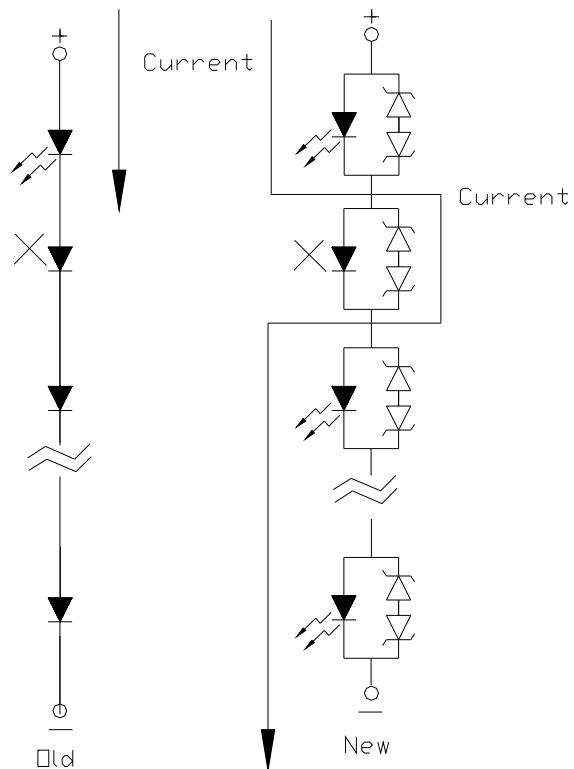

6. Heat Management

- Heat management of LEDs must be taken into consideration during the design stage of LED application. The current should be de-rated appropriately by referring to the de-rating curve found in each product specification.
- The temperature surrounding the LED in the application should be controlled. Please refer to the data sheet de-rating curve.



LIGHTING FOREVER

Technical Data Sheet

334-15/X2C1-1SUA

7. ESD (Electrostatic Discharge)

- Electrostatic discharge (ESD) or surge current (EOS) can damage LEDs.
- An ESD wrist strap, ESD shoe strap or antistatic gloves must be worn whenever handling LEDs.
- All devices, equipment and machinery must be properly grounded.
- Use ion blower to neutralize the static charge which might have built up on surface of the LEDs plastic lens as a result of friction between LEDs during storage and handing.

8. Other

- Above specification may be changed without notice. EVERLIGHT will reserve authority on material change for above specification.
- When using this product, please observe the absolute maximum ratings and the instructions for using outlined in these specification sheets. EVERLIGHT assumes no responsibility for any damage resulting from use of the product which does not comply with the absolute maximum ratings and the instructions included in these specification sheets.
- These specification sheets include materials protected under copyright of EVERLIGHT corporation. Please don't reproduce or cause anyone to reproduce them without EVERLIGHT's consent.

EVERLIGHT ELECTRONICS CO., LTD.

Tel: 886-2-2267-2000, 2267-9936

Office: No 25, Lane 76, Sec 3, Chung Yang Rd,

Fax: 886-2267-6244,