

GABRIELLA-45-M

~25° medium beam with holder

TECHNICAL SPECIFICATIONS:

Dimensions	Ø 45.0 mm
Height	28.9 mm
Fastening	screw
ROHS compliant	yes ⓘ

MATERIAL SPECIFICATIONS:

Component	Type	Material	Colour	Finish
GABRIELLA-45-M	Single lens	PMMA	clear	
GABRIELLA-45-HLD	Holder	PC	black	

ORDERING INFORMATION:



Component		Qty in box	MOQ	MPQ	Box weight (kg)
CN15815_GABRIELLA-45-M	Single lens	405		45	0.0
» Box size:					

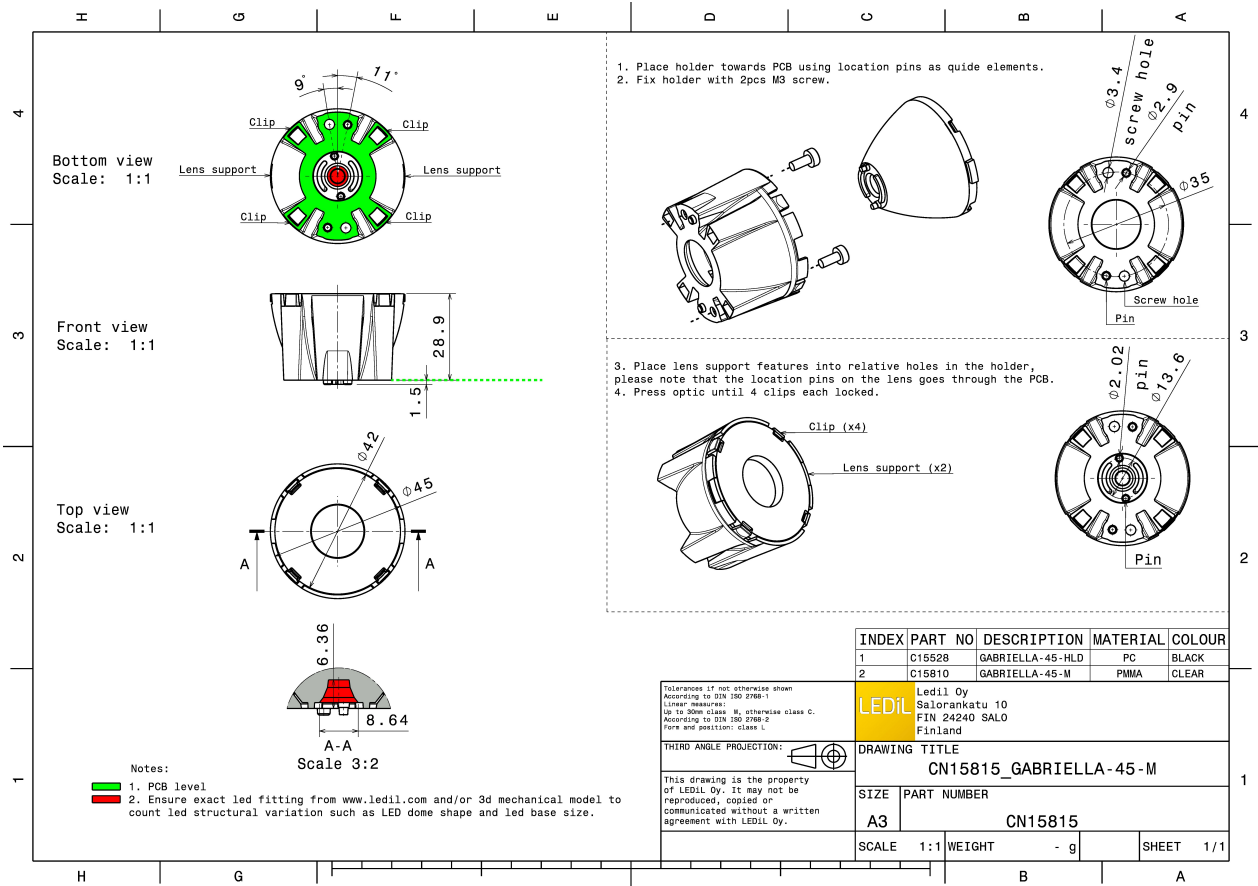





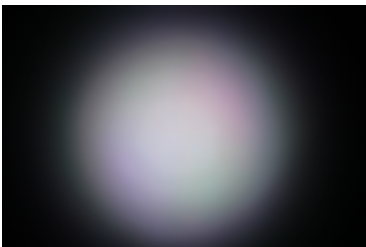
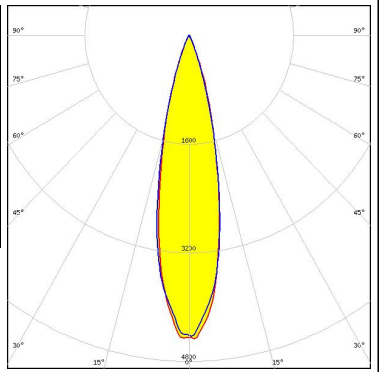

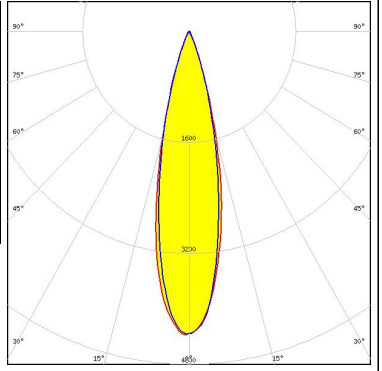
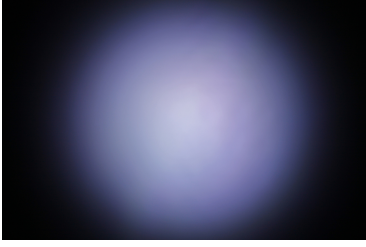
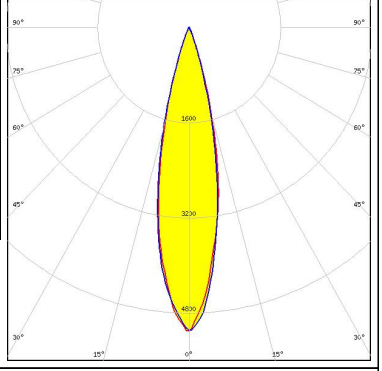
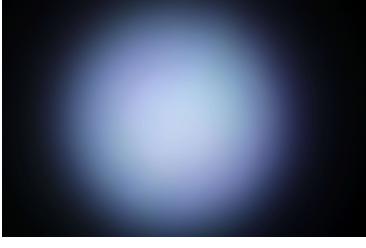
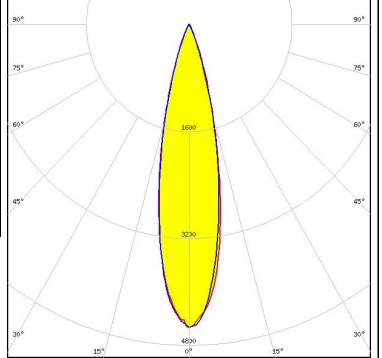

See also our general installation guide: www.ledil.com/installation_guide

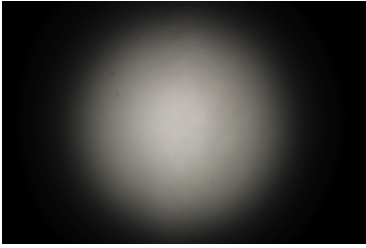
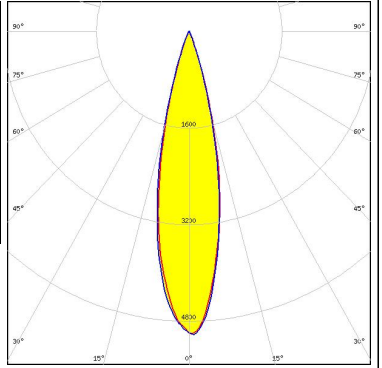

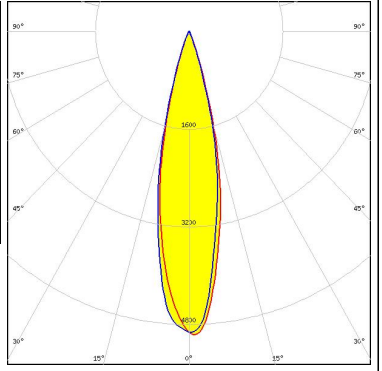
PHOTOMETRIC DATA (MEASURED):

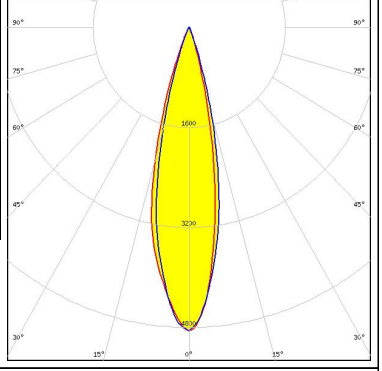
<p>LUMILEDS</p> <p>LED LUXEON CZ</p> <p>FWHM / FWTM 23.0° / 43.0°</p> <p>Efficiency 89 %</p> <p>Peak intensity 4.5 cd/m</p> <p>LEDs/each optic 4</p> <p>Light colour RGBW</p> <p>Required components:</p>		
<p>LUMILEDS</p> <p>LED LUXEON MultiColor Module 2.5W</p> <p>FWHM / FWTM 24.0° / 43.0°</p> <p>Efficiency 89 %</p> <p>Peak intensity 4.4 cd/m</p> <p>LEDs/each optic 1</p> <p>Light colour RGBW</p> <p>Required components:</p>		
<p>LUMINUS</p> <p>LED SBM-40-RGBW</p> <p>FWHM / FWTM 23.0° / 39.0°</p> <p>Efficiency 89 %</p> <p>Peak intensity 5.1 cd/m</p> <p>LEDs/each optic 1</p> <p>Light colour White</p> <p>Required components:</p>		
<p>NICHIA</p> <p>LED NCSxE17A</p> <p>FWHM / FWTM 24.0° / 42.0°</p> <p>Efficiency 90 %</p> <p>Peak intensity 4.6 cd/m</p> <p>LEDs/each optic 4</p> <p>Light colour RGBW</p> <p>Required components:</p>		

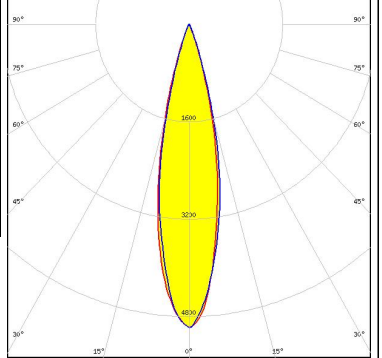
PHOTOMETRIC DATA (MEASURED):

<p>NICHIA</p> <p>LED NVSW219F FWHM / FWTM 24.0° / 40.0° Efficiency 90 % Peak intensity 5 cd/lm LEDs/each optic 1 Light colour White Required components:</p>		
<p>OSRAM Opto Semiconductors</p> <p>LED OSLON Square EC FWHM / FWTM 24.0° / 39.0° Efficiency 88 % Peak intensity 5 cd/lm LEDs/each optic 1 Light colour White Required components:</p>		
<p>OSRAM Opto Semiconductors</p> <p>LED Ostar-SMT RGB FWHM / FWTM 24.0° / 40.0° Efficiency 90 % Peak intensity 4.9 cd/lm LEDs/each optic 1 Light colour White Required components:</p>		
<p>SEOUL SEMICONDUCTOR</p> <p>LED SPF05F0A FWHM / FWTM 24.0° / 39.0° Efficiency 88 % Peak intensity 5 cd/lm LEDs/each optic 1 Light colour RGBW Required components:</p>		

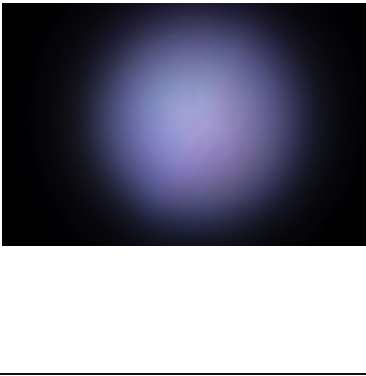
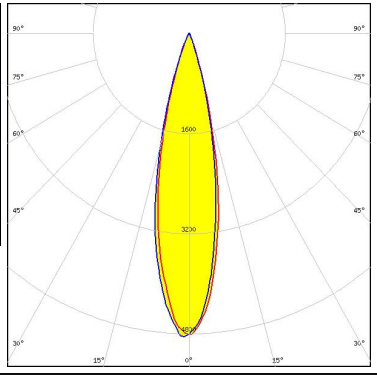
PHOTOMETRIC DATA (MEASURED):

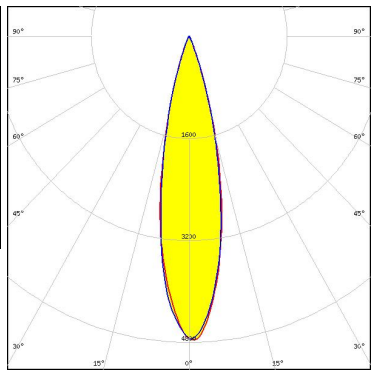
<p> SEUL SEMICONDUCTOR</p> <p>LED SPF05F0B</p> <p>FWHM / FWTM 24.0° / 40.0°</p> <p>Efficiency 88 %</p> <p>Peak intensity 4.9 cd/m</p> <p>LEDs/each optic 1</p> <p>Light colour RGBW</p> <p>Required components:</p>		
<p> SEUL SEMICONDUCTOR</p> <p>LED SPF05F0C</p> <p>FWHM / FWTM 24.0° / 41.0°</p> <p>Efficiency 89 %</p> <p>Peak intensity 4.8 cd/m</p> <p>LEDs/each optic 1</p> <p>Light colour RGBW</p> <p>Required components:</p>		

PHOTOMETRIC DATA (SIMULATED):



LED J Series 5050 Round LES
 FWHM / FWTM 23.0° / 40.0°
 Efficiency 92 %
 Peak intensity 5.2 cd/lm
 LEDs/each optic 1
 Light colour White
 Required components:

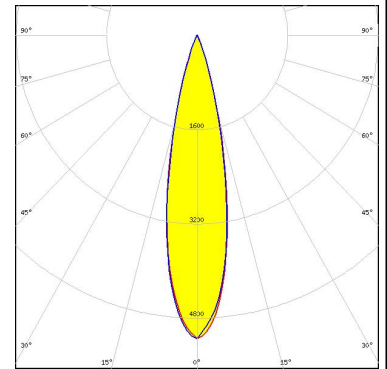

LED XHP50.2
 FWHM / FWTM 22.0° / 40.0°
 Efficiency 89 %
 Peak intensity 5.1 cd/lm
 LEDs/each optic 1
 Light colour White
 Required components:

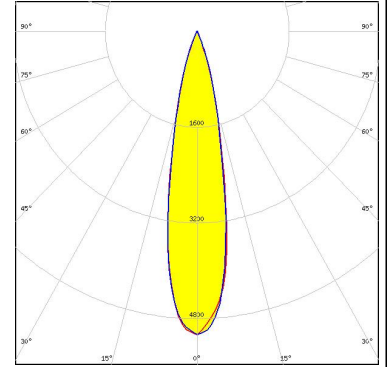

LED XHP70.2
 FWHM / FWTM 24.0° / 44.0°
 Efficiency 87 %
 Peak intensity 4 cd/lm
 LEDs/each optic 1
 Light colour White
 Required components:

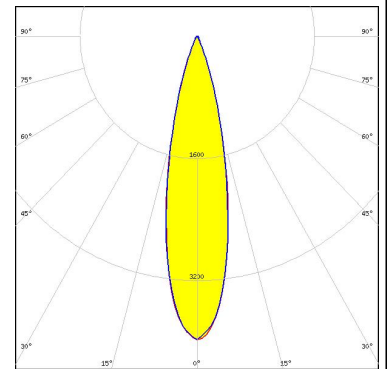

LED XM-L RGB
 FWHM / FWTM 23.0° / 42.0°
 Efficiency 85 %
 Peak intensity 4.5 cd/lm
 LEDs/each optic 1
 Light colour White
 Required components:

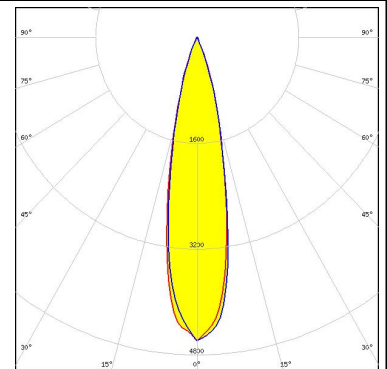

PHOTOMETRIC DATA (SIMULATED):

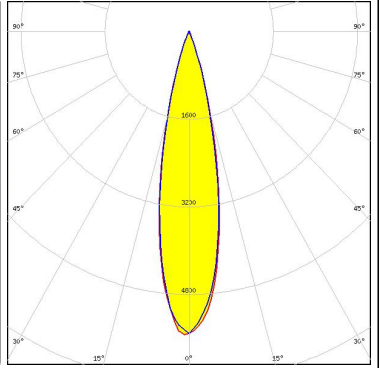
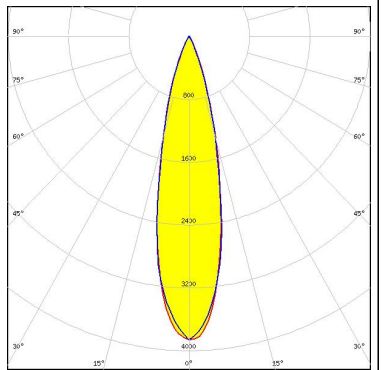
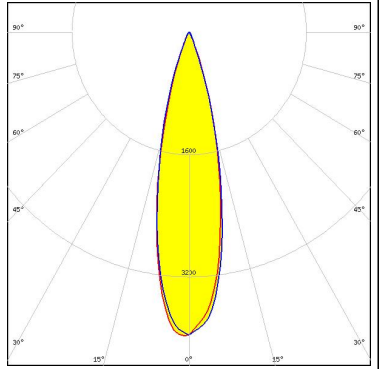
<p>LED ENGIN</p> <p>LED LZ7 Plus (LZ7-04M2PD) FWHM / FWTM 23.0° / 39.0° Efficiency 93 % Peak intensity 5.5 cd/lm LEDs/each optic 1 Light colour White Required components:</p>		
<p>LUMILEDS</p> <p>LED LUXEON C FWHM / FWTM 24.0° Efficiency 86 % Peak intensity 4 cd/lm LEDs/each optic 4 Light colour RGBW Required components:</p>		
<p>OSRAM <small>Opto Semiconductors</small></p> <p>LED OSTAR Stage (S2WP) FWHM / FWTM 25.0° Efficiency 86 % Peak intensity 4 cd/lm LEDs/each optic 1 Light colour White Required components:</p>		

GENERAL INFORMATION:

NOTE: The typical beam angle will be changed by different color, chip size and chip position tolerance. The typical total beam angle is the full angle measured where the luminous intensity is half of the peak value.

MATERIALS:

As part of our continuous research and improvement processes, and to ensure the best possible quality and availability of our products, LEDiL reserves the right to change material grades without notice.

PRODUCT DATA USER AGREEMENT AND DISCLAIMER:

The measured data in the provided downloadable LEDiL Product Datasheets and Mechanical 2D-Drawings is rounded and provided as reference for planning. LEDiL Oy's optical specifications have been verified by conducting performance testing of the products in accordance with the company's quality system. The reported data are averaged results of multiple measurements with typical variation. LEDiL Oy reserves the right to without prior notification make changes and improvements to its products.

LEDiL Oy assumes neither warranty, nor guarantee nor any other liability of any kind for the contents and correctness of the provided data. The provided data has been generated with highest diligence but the provided data may in reality not represent the complete possible variation range of all intrinsic parameters. Therefore, in certain cases a deviation from the provided data could occur.

LEDiL Oy reserves the right to undertake technical changes of its products without further notification which could lead to changes in the provided data. LEDiL Oy assumes no liability of any kind for the possible deviation from any provided data or any other damage resulting from the usage of the provided data.

The user agrees to this disclaimer and user agreement with the download or usage of the provided files.

LEDiL Oy

Joensuunkatu 13
FI-24240 SALO
Finland

LEDiL Inc.

228 West Page Street
Suite D
Sycamore IL 60178
USA

Ledil Optics Technology (Shenzhen) Co., Ltd.

405 , Block B
Casic Motor Building
Shenzhen 518057
P.R.CHINA

Local sales and technical support

[www.ledil.com/
where_to_buy](http://www.ledil.com/where_to_buy)

Shipping locations

Salo, Finland
Hong Kong, China

Distribution Partners

[www.ledil.com/
where_to_buy](http://www.ledil.com/where_to_buy)