

Datasheet

2.4-2.5Ghz & 5.15-5.85GHz  
External / In-building



Stick Antenna

**Features:**

High performing Wi-Fi dual-band antenna with SMA/RP-SMA connector for indoor applications

**Applications:**

- CPE – Router, Set-top boxes, Gateway
- IoT devices
- Wi-Fi Mesh
- Smart Metering
- Robotics



**Electrical Specifications**

**Antenna Characteristics**

Antenna Type	Radiation Pattern	Polarization	Max. Input Power	Impedance
Stick Antenna	Omni	Linear	2W	50Ω

Frequency (GHz)	2.4 – 2.5	5.15 – 5.85
Return Loss (dB)	< -10	< -10
Gain, Peak / Average (dB)	2.8 / -1.2	4.9 / -1.0
Efficiency / Average (%)	75	79

**Mechanical Specifications**

**Environmental**

Temperature Range (°C)	-40 to 85
Humidity	Non-condensing 65°C 95% RH

RoHS Compliant

Part Number	Length (mm)	Weight (g)	Connector Type	Radome
ST0228-30-001-A	196	19.76	SMA Plug	TPEE/ABS
ST0228-30-501-A	196	19.76	RP-SMA Plug	TPEE/ABS

**Mechanical Drawing**

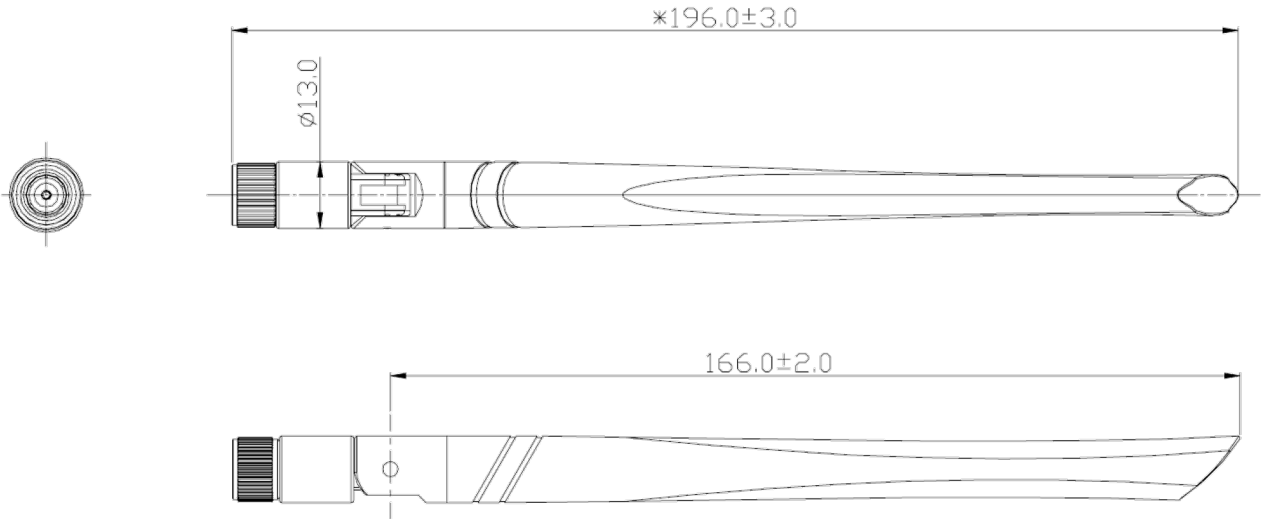

SMA Plug

ST0228-30-001-A



RP-SMA Plug

ST0228-30-501-A

Charts in Free Space

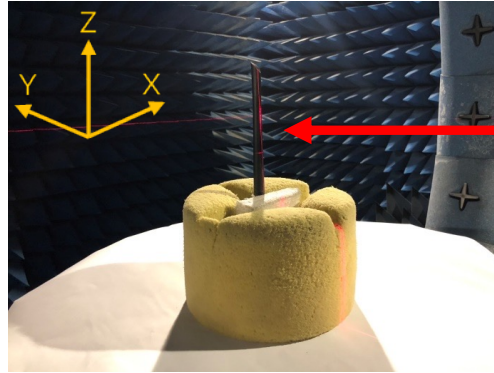

ST0228-30-501-A

Test setup, measurement performed in 3D Anechoic Chamber

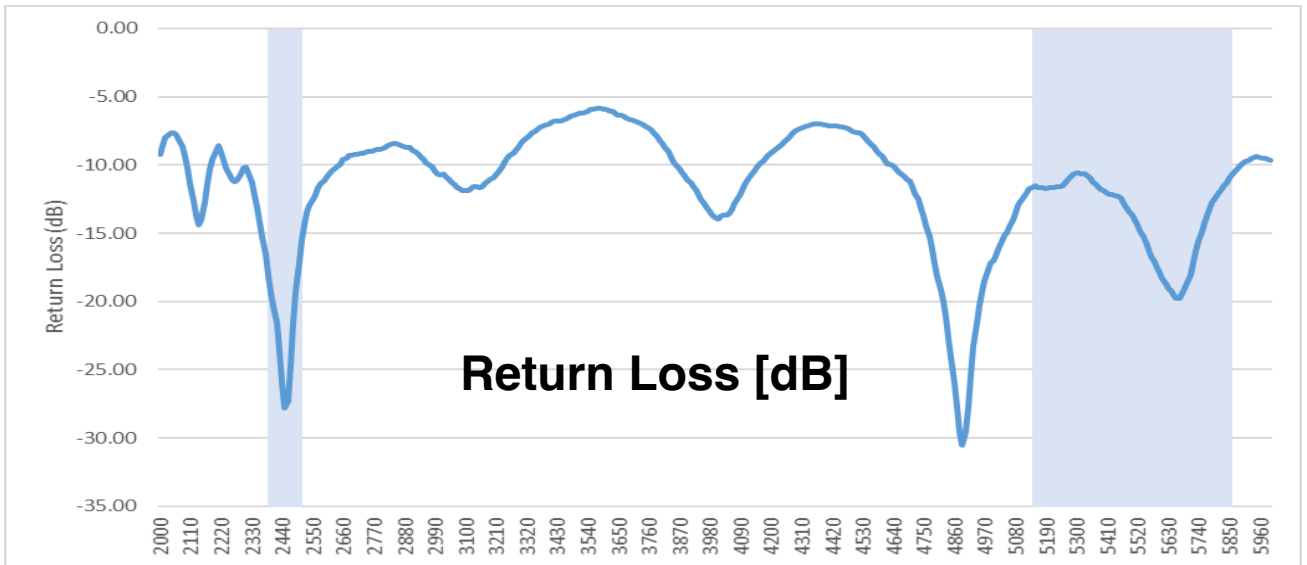

Blue background represents frequency response.

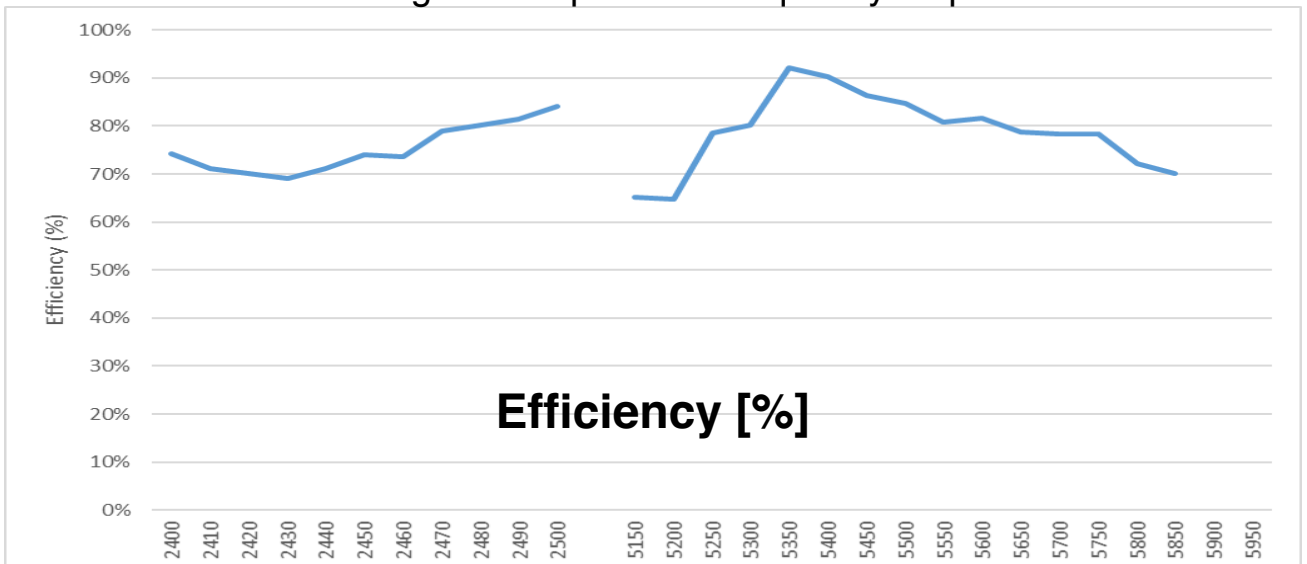

Radiation Pattern - Free Space

XY - Plane

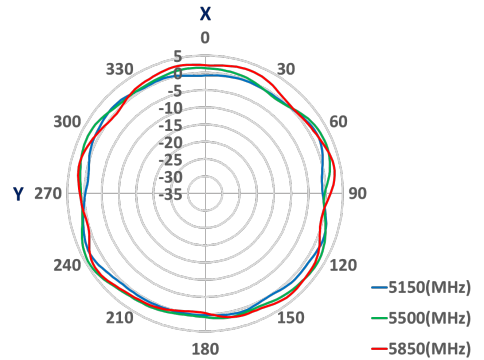
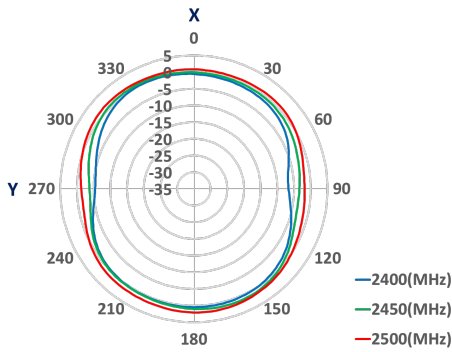

YZ - Plane

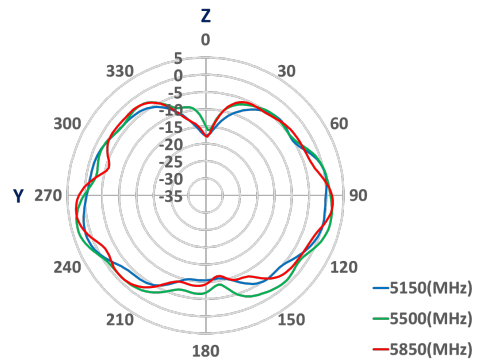
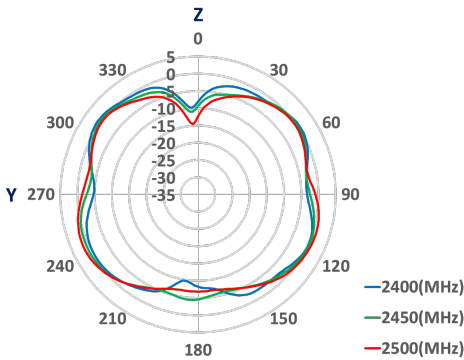

XZ - Plane

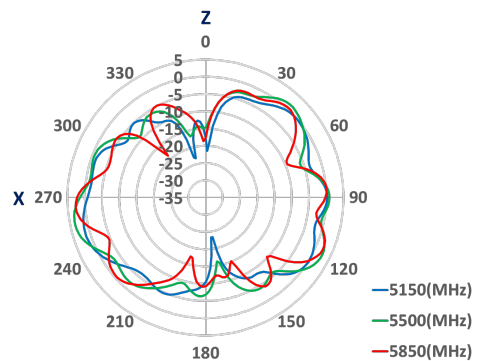
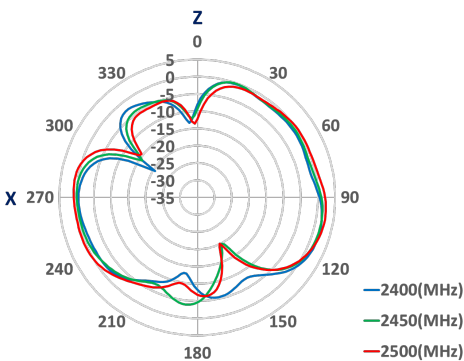

Revisions

Rev	Description	Date	ECN	Approval
A	Initial Release	2022-10-25	ST0228-30-X01-A-RA00	ATC
B	RF Performance update	2023-01-02	ST0228-30-X01-A-RB00	ATC

NOTICE - These drawings, specifications, or other data ( 1) are, and remain the property of Amphenol corp. (2) must be returned upon request; and (3) are confidential and not to be disclosed to any person other than those to whom they are given by Amphenol Corp. the furnishing of these drawings, specifications, or other data by Amphenol Corp., or to any other person to anyone for any purpose is not to be regarded by implication or otherwise in any manner licensing, granting rights to permitting such holder or any other person to manufacture, use or sell any product, process or design, patented or otherwise, that may in any way be related to or disclosed by said drawings, specifications, or other data.