

Interface module - VIP-3/SC/D25SUB/M/LED - 2322168

Please be informed that the data shown in this PDF Document is generated from our Online Catalog. Please find the complete data in the user's documentation. Our General Terms of Use for Downloads are valid (<http://phoenixcontact.com/download>)



VARIOFACE module, with screw connection and D-Subminiature pin strip, for mounting on NS 35 rails, with LED, 25-pos.

Your advantages

- 9 to 50-pos.
- Metal foot
- According to IEC 60603-13
- 1:1 connection
- Screw connection



Key Commercial Data

Packing unit	1 pc
GTIN	 4 046356 451789
GTIN	4046356451789

Technical data

Dimensions

Width	57.4 mm
Height	69 mm
Depth	62 mm

Ambient conditions

Ambient temperature (operation)	-20 °C ... 50 °C
Ambient temperature (storage/transport)	-20 °C ... 70 °C

General

Nominal voltage U_N	24 V DC
Max. perm. current (per branch)	2.5 A
Number of positions	25

Interface module - VIP-3/SC/D25SUB/M/LED - 2322168

Technical data

General

Status display	LED
Mounting position	any

Connection data

Connection name	Field level
Connection in acc. with standard	IEC / EN
Connection method	Screw connection
Stripping length	8 mm
Screw thread	M3
Conductor cross section solid	0.2 mm ² ... 4 mm ²
Conductor cross section flexible	0.2 mm ² ... 2.5 mm ²
Conductor cross section AWG	24 ... 12

Connection data 2

Connection name	Controller level
Connection method	D-SUB pin strip
Number of connections	1
Number of positions	25

Standards and Regulations

Connection in acc. with standard	CUL
Standards/regulations	IEC 60664
	DIN EN 50178
Degree of pollution	2
Overvoltage category	II
Flammability rating according to UL 94	V0

Environmental Product Compliance

	Lead 7439-92-1
China RoHS	Environmentally Friendly Use Period = 50
	For details about hazardous substances go to tab "Downloads", Category "Manufacturer's declaration"

Drawings

Interface module - VIP-3/SC/D25SUB/M/LED - 2322168

Dimensional drawing

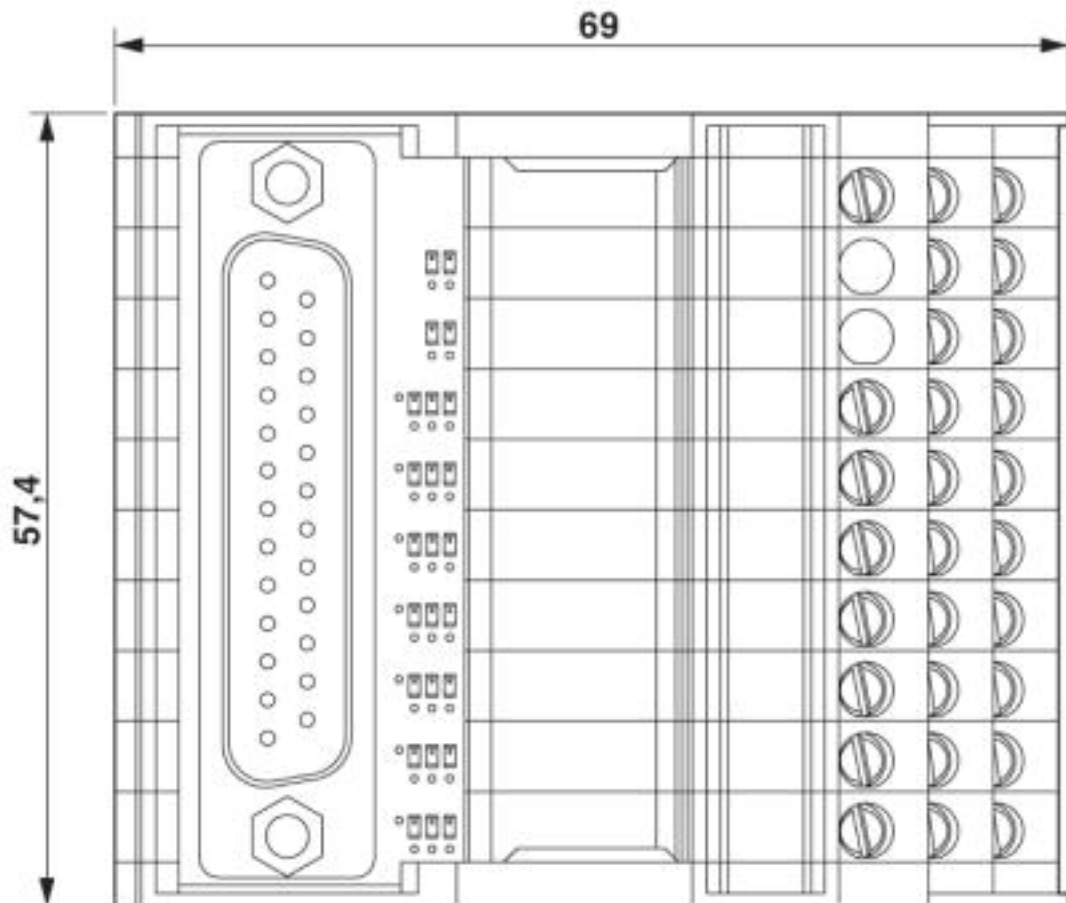

Circuit diagram

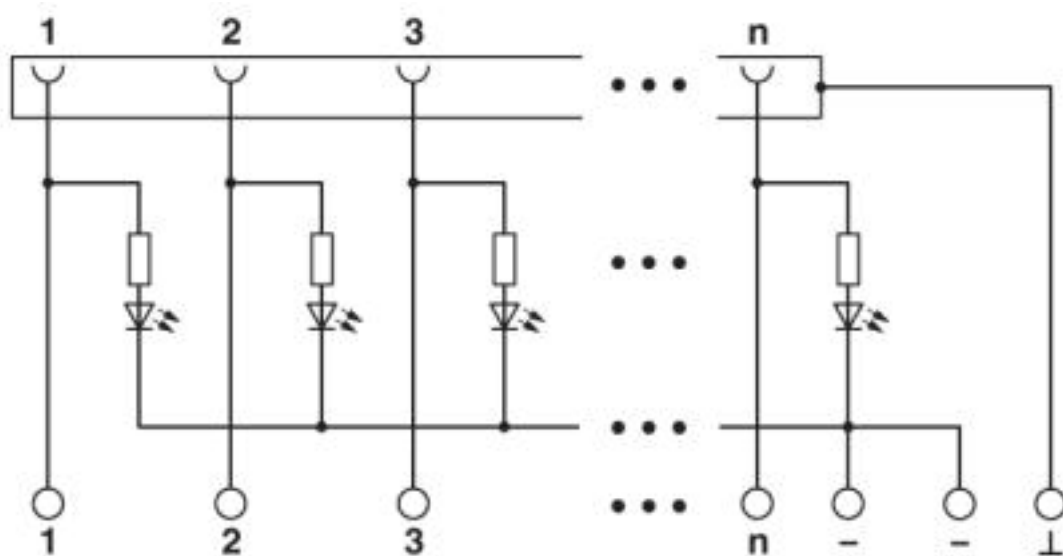

Interface module - VIP-3/SC/D25SUB/M/LED - 2322168

Approvals

Approvals

Approvals

CSA / UL Recognized / cUL Recognized / cULus Recognized

Ex Approvals

Approval details

CSA		http://www.csagroup.org/services-industries/product-listing/	2122203
Nominal voltage UN		24 V	
Nominal current IN		2 A	
mm ² /AWG/kcmil		28-12	

UL Recognized		http://database.ul.com/cgi-bin/XYV/template/LISEXT/1FRAME/index.htm	FILE E 238705
Nominal voltage UN		24 V	
Nominal current IN		2 A	
mm ² /AWG/kcmil		30-12	

cUL Recognized		http://database.ul.com/cgi-bin/XYV/template/LISEXT/1FRAME/index.htm	FILE E 238705
Nominal voltage UN		24 V	
Nominal current IN		2 A	
mm ² /AWG/kcmil		30-12	

cULus Recognized	
------------------	---

Phoenix Contact 2019 © - all rights reserved
<http://www.phoenixcontact.com>

PHOENIX CONTACT GmbH & Co. KG
Flachsmarktstr. 8
32825 Blomberg
Germany
Tel. +49 5235 300
Fax +49 5235 3 41200
<http://www.phoenixcontact.com>