

PSM-HCS-KONFTOOL...

Fiber optic assembly kit for HCS cables
(200/230 μm)

INTERFACE

Data sheet
100333_en_03

© PHOENIX CONTACT - 07/2009



1 Description

The PSM-HCS-KONFTOOL... fiber optic assembly kit contains the tools required to connect connectors to HCS cables (200/230 μm).

Phoenix Contact offers assembly kits for three connector types:

- PSM-HCS-KONFTOOL for F-SMA connectors
- PSM-HCS-KONFTOOL/B-FOC for B-FOC (ST[®]) connectors
- PSM-HCS-KONFTOOL/SC-RJ for SCRJ connectors

This tool set enables quick local assembly of HCS cables. It eliminates the need for complex assembly steps, such as crimping, bonding, and polishing. The amount of time required is thus considerably reduced.

The required assembly steps are:

- Strip the fibers
- Push on the individual parts of the connector
- Assemble the connector
- Cleave and break the fibers at the front of the connector



When laying and installing fiber optic cables please observe the IBS SYS FOC ASSEMBLY installation guidelines (included in the scope of supply).



Following assembly, insert both **SCRJ connectors** in the duplex frame, so they cannot be removed again.



Make sure you always use the latest documentation.
It can be downloaded at www.phoenixcontact.net/download.



This data sheet is valid for all products listed on the following page:

Table of contents

1	Description.....	1
2	Ordering data.....	3
3	Technical data	3
4	Scope of supply	4
5	Assembling HCS fibers.....	5
5.1	Basic information.....	5
5.2	Cutting the cable sheath lengthways	5
5.3	Removing the tearing wire.....	5
5.4	Tearing open the cable sheath	6
5.5	Removing the individual wires	6
5.6	Preparing the connector	6
5.7	Pushing on the bend protection sleeve and the clamping nut.....	6
5.8	Stripping the individual wires	7
5.9	Removing the fiber protection layer (coating)	7
5.10	Cutting off the strain relief.....	8
5.11	Pushing on the wire clamp.....	8
5.12	Screwing on the basic unit of the connector	8
5.13	Preparing the fiber cleaving tool	8
5.14	Assembling F-SMA connectors	8
5.15	Inserting and locking B-FOC connectors	9
5.16	Inserting and snapping in SCRJ connectors.....	9
5.17	Securing and tightening the fiber	9
5.18	Cleaving and breaking the fiber	10
5.19	Cleaning the connector	10
5.20	Checking the quality	10
5.21	Assessing the quality.....	11
6	Assembling the SCRJ connector	11
6.1	Assembly.....	11
7	Dimensional drawings.....	12
7.1	Dimensions of F-SMA connector.....	12
7.2	Dimensions of B-FOC connector.....	12
7.3	Dimensions of SCRJ connector.....	12
8	Specification of HCS cables	13

2 Ordering data

Fiber optic assembly kit

Description	Type	Order No.	Pcs./Pkt.
Fiber optic assembly kit for HCS cables (200/230 µm) with F-SMA connectors	PSM-HCS-KONFTOOL	2799526	1
Fiber optic assembly kit for HCS cables (200/230 µm) with B-FOC (ST) connectors	PSM-HCS-KONFTOOL/B-FOC	2708465	1
Fiber optic assembly kit for HCS cables (200/230 µm) with SCRJ connectors	PSM-HCS-KONFTOOL/SC-RJ	2708876	1

Accessories

Description	Type	Order No.	Pcs./Pkt.
F-SMA connector set for self-assembly of quick mounting connectors for HCS fibers	PSM-SET-FSMA/4-HCS	2799487	4
B-FOC (ST®) connector set for self-assembly of quick mounting connectors for HCS fibers	PSM-SET-B-FOC/4-HCS	2708481	4
SCRJ connector set for self-assembly of quick mounting connectors for HCS fibers (1 duplex connector)	VS-SCRJ-HCS-FA-IP20	1654866	1
SCRJ connector set for self-assembly of quick mounting connectors for HCS fibers (2 duplex connectors)	PSM-SET-SCRJ-DUP/2-HCS	2313070	2
Fiber cleaving tool for F-SMA connectors	PSM-HCS-CLEAVETOOL	2744995	1
Fiber cleaving tool for B-FOC connectors	PSM-HCS-CLEAVETOOL/B-FOC	2708478	1
Fiber cleaving tool for SCRJ connectors	PSM-HCS-CLEAVETOOL/SCRJ	2313122	1
Stripping blade	KAMES LWL	1206146	1
Stripping pliers for individual wires	PSM-FO-STRIP	2744199	1
Measuring instrument case	PSM-FO-POWERMETER	2799539	1
HCS cable, duplex, 200/230 µm, sold by the meter without connectors			
Indoor installation	PSM-LWL-HCS-RUGGED-200/230	2799885	Sold by the meter
Outdoor installation	PSM-LWL-HCSO-200/230	2799445	Sold by the meter

Documentation

Description	Type	Order No.	Pcs./Pkt.
Fiber optic installation guidelines	DB GB IBS SYS FOC ASSEMBLY	9423439	1

3 Technical data

F-SMA connectors

Type	F-SMA, type 905 according to IEC 60874-2
Diameter	8.1 mm
Length including bend protection sleeve	63.3 mm (when assembled)
Suitable fiber type	200/230 µm step index with individual wires Ø 2.9 mm
Insertion loss	< 2 dB
Assembly method	Triple clamping when connector is assembled
Pull-out forces	100 N, minimum
Tightening torque	0.2 Nm, minimum; 0.5 Nm, maximum
Operating temperature	-20°C ... +70°C
Insertion/withdrawal cycles	> 250
Degree of protection	IP20

B-FOC (ST®) connectors

Type	B-FOC (ST®)
Diameter	9.5 mm
Length including bend protection sleeve	63.3 mm (when assembled)
Suitable fiber type	200/230 µm step index with individual wires Ø 2.9 mm
Insertion loss	< 2 dB
Assembly method	Triple clamping when connector is assembled
Pull-out forces	100 N, minimum
Tightening torque	0.2 Nm, minimum; 0.5 Nm, maximum
Operating temperature	-20°C ... +70°C
Insertion/withdrawal cycles	> 250
Degree of protection	IP20

SCRJ connectors

Type	SCRJ, socket face according to EN 50277-6-1
External connector width	16.4 mm
Connector height	11.0 mm
Length including bend protection sleeve	88.5 mm (when assembled)
Suitable fiber type	200/230 µm step index with individual wires Ø 2.9 mm
Insertion loss	< 1.5 dB
Assembly method	Triple clamping when connector is assembled
Pull-out forces	85 N, minimum
Tightening torque	0.2 Nm, minimum; 0.5 Nm, maximum
Operating temperature	-20°C ... +70°C
Insertion/withdrawal cycles	> 250
Degree of protection	IP20

4 Scope of supply

Figure 1 Scope of supply

- 1 Stripping blade
- 2 F-SMA connectors (4 pcs.) or B-FOC connectors (4 pcs.) or SCRJ connectors (2 duplex connectors)
- 3 Stripping pliers for individual wires
- 4 Wire stripper
- 5 Free additional compartment for a waste receptacle (size of a film canister)
- 6 Fiber cleaving tool (for F-SMA, B-FOC or SCRJ)
- 7 Adhesive strips
- 8 Microscope with microscope adapter for B-FOC/SCRJ connectors (both connector types require the same adapter)
- 9 Free additional compartment for a microscope adapter (scope of supply for PSM-SET-FSMA/4-HCS: includes microscope adapter for F-SMA connectors)
- 10 Free additional compartment for a fiber cleaving tool
- 11 Aramide scissors

5 Assembling HCS fibers

5.1 Basic information

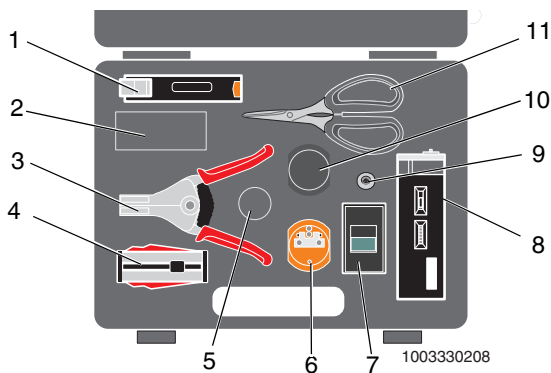

When working with fiber optic cables observe the mechanical properties specified by the manufacturer. Fiber breaks can occur if the bending radii and maximum permissible tractive forces are exceeded or the cable is crushed. For the corresponding data for Phoenix Contact cables, please refer to the Appendix.



The fast connection technology described here is suitable for cable lengths up to 400 m. The individual wires of HCS cables must have a cross-section of 2.9 mm.



The thin fibers of fiber optic cables are protected by a complex cable structure. These insulating/protective layers must be removed from fibers for assembly.



A tape measure is printed on the last page to provide assistance with stripping the specified lengths.

5.2 Cutting the cable sheath lengthways

- Position the cable cross-section so that the cable is cut along the aramide yarn or the tearing wire.
- Place the stripping blade (KAMES LWL) on the cable sheath approximately 10 cm away from the cable end. Pull the stripping blade lengthways. If necessary repeat this step until the cable sheath is cut open.

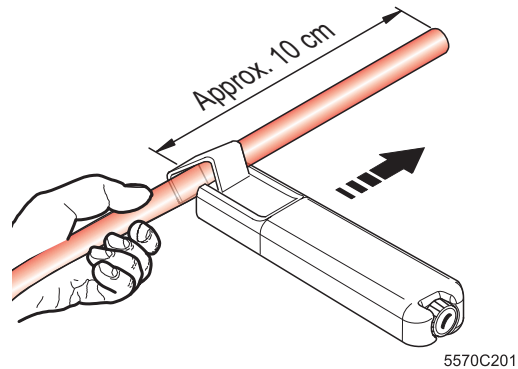

Figure 2 Stripping the outer cable sheath

5.3 Removing the tearing wire

- Remove the tearing wire from the open cable sheath.

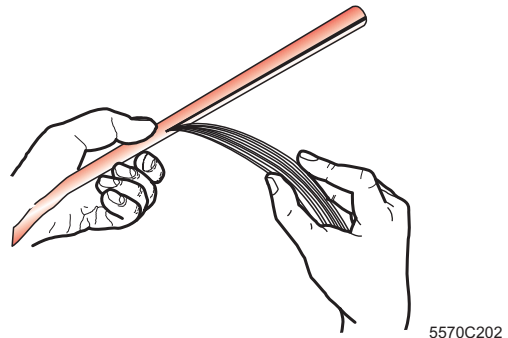

Figure 3 Removing the tearing wire

5.4 Tearing open the cable sheath

- Twist the tearing wire around a supporting tool (e.g., screwdriver, pliers) and make sure it is secure.
- Use the tearing wire to tear open approximately another 20 cm of the outer cable sheath without bending the cable.

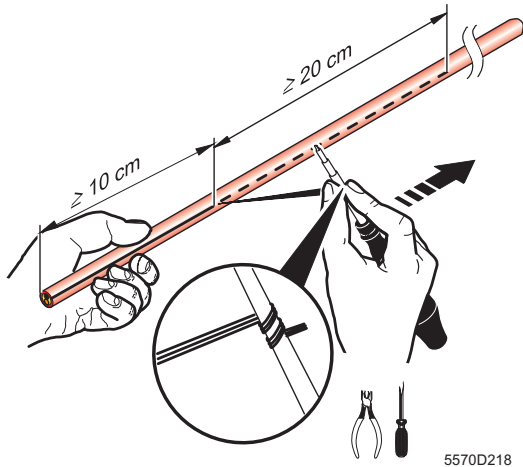

Figure 4 Tearing open the cable sheath

5.5 Removing the individual wires



The two individual wires must not be damaged.

- Cut off the outer cable sheath and – depending on the cable type – the ties, rodent protection, and swelling yarns at the end of the slit area using aramide scissors (A), without damaging the individual wires.
- Shorten the individual wires by 12 cm, as this part can be damaged by stripping the cable with the cable knife (B).

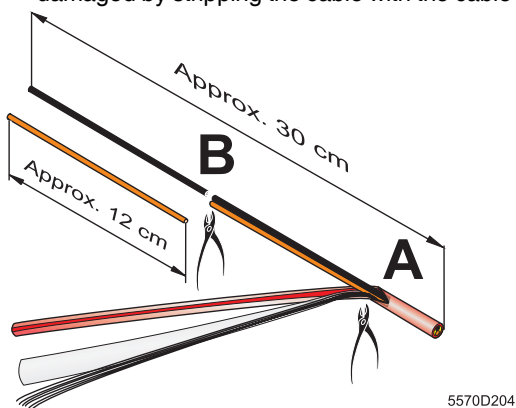

Figure 5 Removing the individual wires

5.6 Preparing the connector



Make sure that you do not lose the wire clamp (1 in Figure 6). It is loose in the connector.

- Separate the connector into its individual parts. Hold the connector vertically with the bend protection sleeve pointing downwards and unscrew the connector.
- Remove the protective cap.

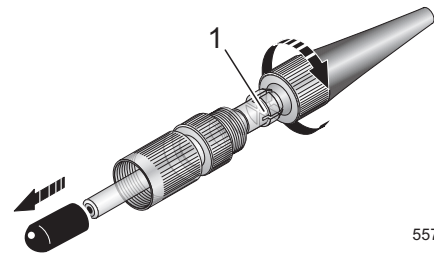

Figure 6 Unscrewing the connector (with the example of an F-SMA connector)

5.7 Pushing on the bend protection sleeve and the clamping nut

- Push the bend protection sleeve with the clamping nut onto the individual wires.

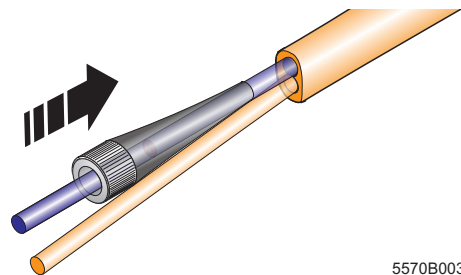

Figure 7 Pushing on the bend protection sleeve

5.8 Stripping the individual wires

- To strip the individual wires, use the 1.6 mm notch of the stripping pliers (second notch from the left).
- Strip approximately 8 cm off the conductor shielding.

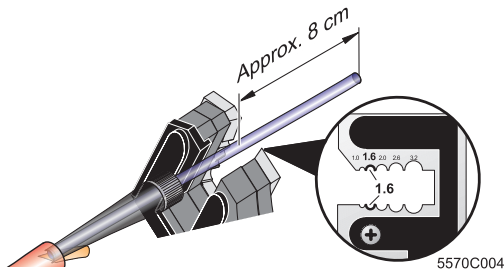

Figure 8 Stripping the individual wires

5.9 Removing the fiber protection layer (coating)



CAUTION: Risk of injury

Without the fiber protection layer, fibers are very thin and can easily pierce the skin.



NOTE: Risk of fiber breaking

Once the fiber protection layer has been removed, the fiber must not be bent sharply. It can easily break.



The kit may contain a fixed or adjustable wire stripper. For the adjustable version, set it to 30 = 0.3 mm.

- Insert the fiber into the front opening of the wire stripper (A).
- Pull the aramide yarn to the side and push the fiber as far as possible into the conductor shielding.
- Push the handles of the stripping pliers firmly together (B) and then, with a jerk, pull the fiber protection layer (coating) from the fiber (C).

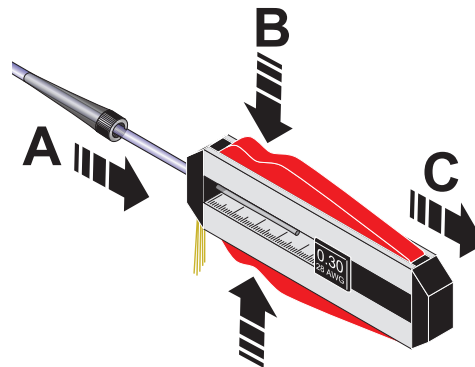

5570B005

Figure 9 Removing the coating

5.10 Cutting off the strain relief

- Using the aramide scissors, shorten the strain relief to approximately 6 mm.

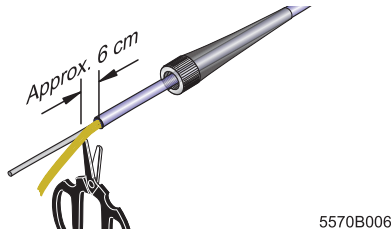

5570B006

Figure 10 Cutting off the strain relief

5.11 Pushing on the wire clamp

- Push the wire clamp over the fiber with the clamping slits towards the back.
- Insert at least 60% of the aramide yarn in the wire clamp. When pushing it into the aramide yarn, turn the wire clamp and push it as far as possible into the conductor shielding. The conductor shielding must be visible through the clamping slits.

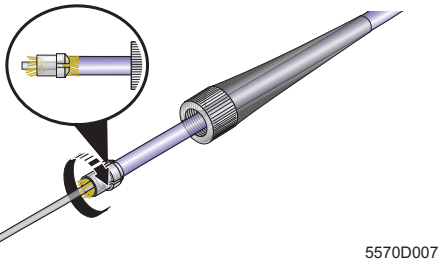

5570D007

Figure 11 Pushing on the wire clamp

5.12 Screwing on the basic unit of the connector

- Carefully insert the fiber in the basic unit.
- Hold the basic unit and then tighten the clamping nut manually (tightening torque of 0.2 Nm to 0.5 Nm).

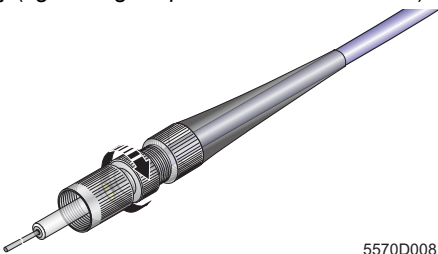

5570D008

Figure 12 Screwing on the basic unit (with the example of an F-SMA connector)

5.13 Preparing the fiber cleaving tool

The fiber cleaving tool is used to break the HCS fiber carefully.



The fiber cleaving tool must not be damaged or dirty.

- Turn the fiber span wheel (1) as far as possible towards the "Open" position (A).
- Turn the fiber cleave wheel (2) towards "Open", position 0 (B). This will lower the fiber span wheel.

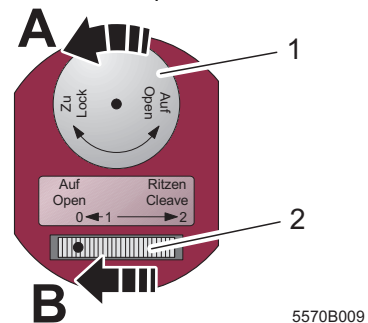

5570B009

Figure 13 Fiber cleaving tool

5.14 Assembling F-SMA connectors

- Carefully wire up the F-SMA connector with the protruding fiber on the underside of the tool (A).

The fiber must be able to pass easily through the tool. It will come out of the drill hole in the fiber span wheel on the opposite side.

- Screw the F-SMA connector as far as possible onto the threads (B).

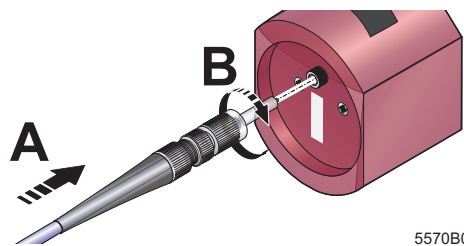

5570B010

Figure 14 Assembling the F-SMA connector with the fiber cleaving tool

5.15 Inserting and locking B-FOC connectors

- Carefully wire up the B-FOC connector with the protruding fiber on the underside of the tool (A).

The fiber must be able to pass easily through the tool. It will come out of the drill hole in the fiber span wheel on the opposite side.

- Push the B-FOC connector onto the bayonet locking, push it down, and turn it clockwise until it snaps into place (B).

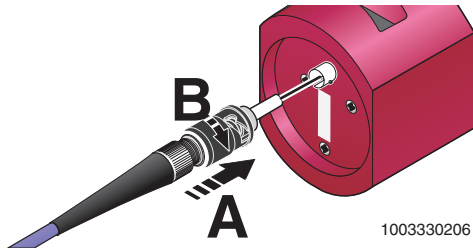

Figure 15 Inserting and locking B-FOC connectors in the fiber cleaving tool

5.16 Inserting and snapping in SCRJ connectors

- Carefully wire up the SCRJ connector with the protruding fiber on the underside of the tool (A).

The fiber must be able to pass easily through the tool. It will come out of the drill hole in the fiber span wheel on the opposite side.

- Push the SCRJ connector into the locking. The connector tabs must snap into the locking on the right and left-hand side (B). This should then prevent the connector from being removed unintentionally.

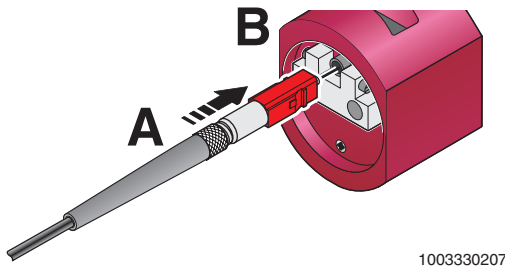

Figure 16 Inserting and snapping in SCRJ connectors in the fiber cleaving tool

5.17 Securing and tightening the fiber



To prevent damage to the fiber cleaving tool, tighten the span wheel carefully.

- Turn the fiber span wheel clockwise towards the "Lock" position (A). The fiber is now secured and tightened in place.

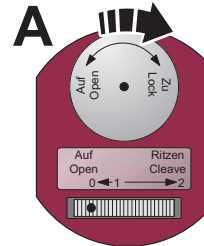

5570B011

Figure 17 Securing the fiber

5.18 Cleaving and breaking the fiber



Please note that during the following step the fiber span wheel (B) should remain mobile (do not hold it or press down on it).

- Turn the fiber cleave wheel (A) slowly from the "Open" position (0), past position (1) to the "Cleave" position (2). This carefully breaks the fiber between position 1 and 2. The fiber span wheel (B) will visibly jump approximately 2 mm forwards.



CAUTION: Risk of injury

You can easily be injured by the remains of the fiber which have been broken off. The ends of the fiber can easily pierce the skin. Dispose of the remains of the fiber in a suitable receptacle (e.g., a film canister).

- Loosen the fiber span wheel (B) and remove the remains of the fiber.
- Unscrew the connector.

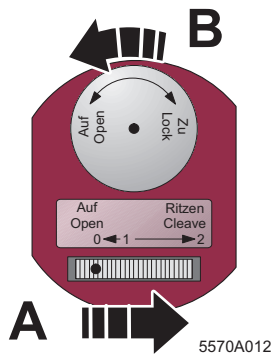

Figure 18 Fiber cleave wheel (A) and fiber span wheel (B)

5.19 Cleaning the connector

- To remove the remains of the fiber, dab the front of the connector with the adhesive strips provided.



Place the protective cap over the connector to prevent the fiber from getting dirty.

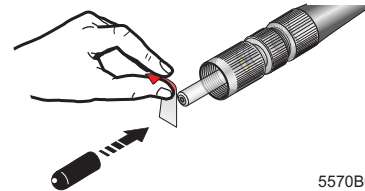

Figure 19 Removing the remains of the fiber (with the example of an F-SMA connector)

5.20 Checking the quality



In the assembly kit, the microscope adapter for B-FOC (ST)/SCRJ connectors is already assembled on the microscope upon delivery. For F-SMA connectors, the F-SMA microscope adapter is also included in the F-SMA assembly kit.

- Assemble the corresponding microscope adapter.
- Insert the connector in the opening provided (A) and switch on the microscope (B).
- View the front of the connector with the microscope (C).
- Adjust the visual acuity with the focusing screw on the side (D).

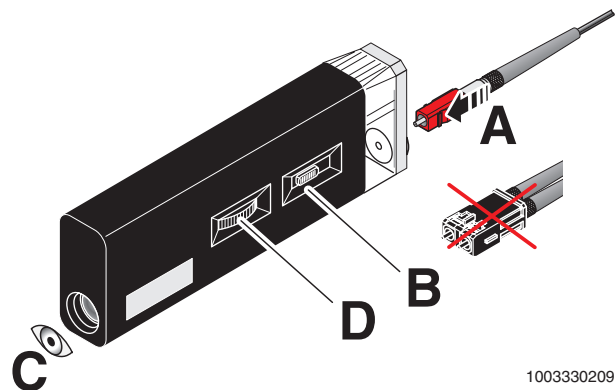
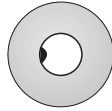

Figure 20 Microscope (example: SCRJ connector)

5.21 Assessing the quality

- Example of good assembly.



5570A015

- Dust or remains of the fiber on the fiber or connector. These impurities increase the attenuation.

Clean the connector. To remove the remains of the fiber, dab the front of the connector with the adhesive strips provided.

- Individual splinters on the fiber edge. Optical power is hardly affected. Measure the optical power to check the quality.



5570A016

- Grooves, scratches or large surface splinters. These increase the attenuation to impermissible levels. Reassemble.



5570A017

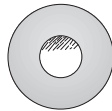

5570A018



In large fiber optic installations, it is advisable to document the optical attenuation of the cables laid in the installation plans. For F-SMA and ST connectors, the optical power measuring instrument (PSM-FO- POWERMETER, Order No. 2799539) is available.



Fiber optic installations with SCRJ connectors cannot be checked using the PSM-FO- POWERMETER optical power measuring instrument.

6 Assembling the SCRJ connector



Following assembly, insert both **SCRJ connectors** in the duplex frame, so they cannot be removed again.

6.1 Assembly

- Insert both assembled SCRJ connectors in the duplex frame with the tab pointing upwards. They engage with a click and cannot be pulled out again.

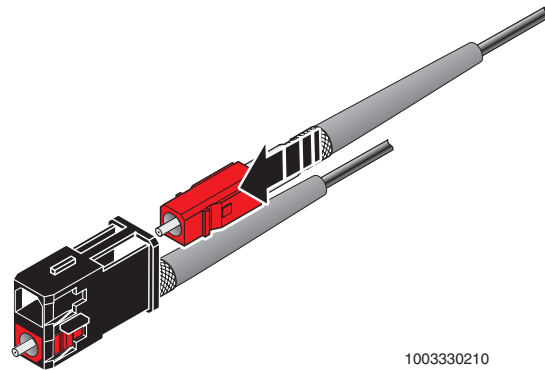

1003330210

Figure 21 Assembling the SCRJ connectors

7 Dimensional drawings

7.1 Dimensions of F-SMA connector

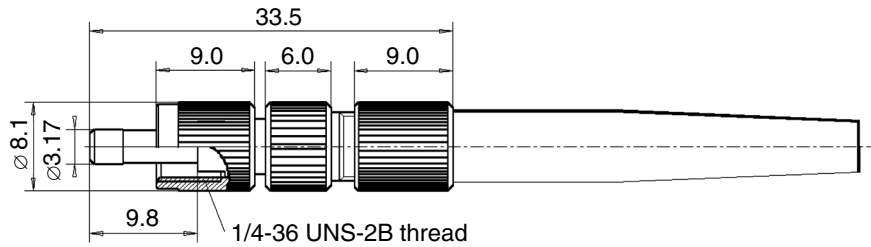

Figure 22 Dimensional drawing of F-SMA connector (in mm)

7.2 Dimensions of B-FOC connector

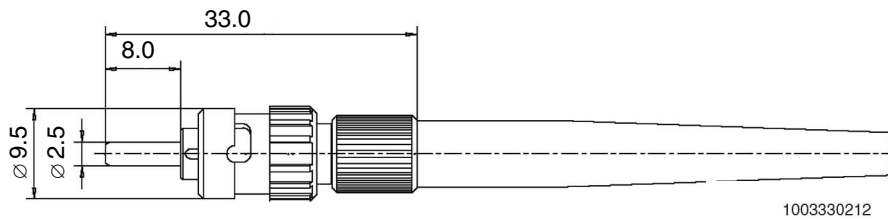

Figure 23 Dimensional drawing of B-FOC connector (in mm)

7.3 Dimensions of SCRJ connector

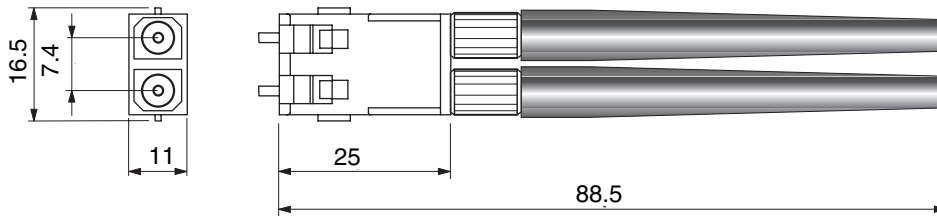
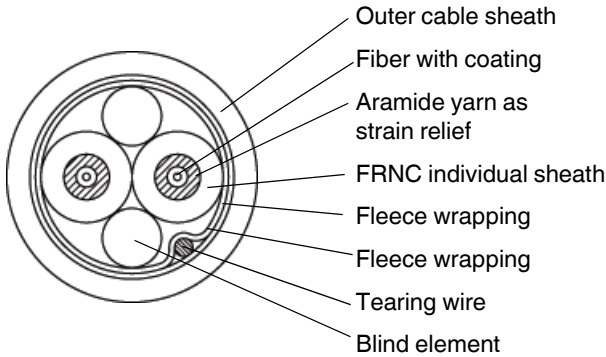

Figure 24 Dimensional drawing of F-SMA connector (in mm)

8 Specification of HCS cables

Indoor cable



Outdoor cable

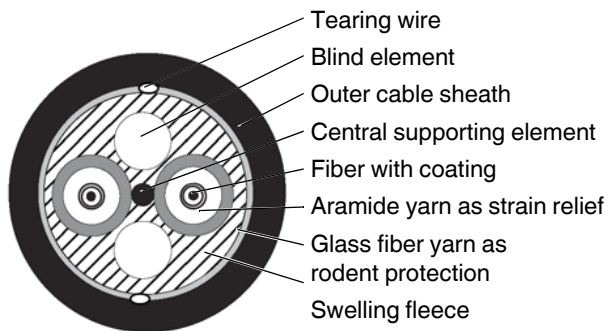

	HCS cable for permanent indoor installation	HCS cable for permanent outdoor installation
	PSM-LWL-HCS-RUGGED-230/230	PSM-LWL-HCSO-200/230
Fiber		
Core/sheath diameter	200/230 µm	200/230 µm
Refractive index profile	Step index	Step index
Bandwidth length product at 650 nm	≥ 17 MHz x km	≥ 17 MHz x km
Bandwidth length product at 850 nm	≥ 20 MHz x km	≥ 20 MHz x km
Attenuation at 650 nm LED	≤ 10 dB/km	≤ 10 dB/km
Attenuation at 850 nm LED	≤ 8 dB/km	≤ 8 dB/km
Individual wire		
Material	Copolymer FRNC (flame-retardant and non-corrosive)	Copolymer FRNC (flame-retardant and non-corrosive)
Color	Red/green	Red/green
Strain relief	Non-metal, aramide yarn	Non-metal, aramide yarn
Outside diameter	2.9 mm ±0.1 mm (for 3 mm crimping)	2.9 mm ±0.1 mm (for 3 mm crimping)
Outer cable sheath		
Material	Polyurethane (PUR)	Polyethylene (PE)
Color	Orange	Black
Diameter	8.0 mm ±0.5 mm	11.0 mm, approximately
Rodent protection	-	Glass yarn
Imprinting	PHOENIX CONTACT FIBER OPTIC CABLE and running length specification in m I-VH11Y 2K200/230 10A17+8B20 HCS RUGGED	PHOENIX CONTACT FOC L (date MM/YY) AT-VQH(B)2Y 2K200/230 10A17 + 8B20 and running length specification in m
Tearing wire	Aramide yarn under the sheath	Aramide yarn under the sheath
Temperature range		
Storage	-40°C ... +70°C	-25°C ... +70°C
Installation	-20°C ... +60°C	-5°C ... +50°C
Operation with pre-assembled connectors	-40°C ... +70°C	-40°C ... +70°C
Operation with quick mounting connectors	-20°C ... +70°C	-20°C ... +70°C
Weight	54 kg/km	97 kg/km
Bending radius (individual wires)		
Temporary	≥ 30 mm	≥ 30 mm
Permanent	≥ 50 mm	≥ 50 mm
Bending radius (cable), ICE 60 794-1-2, method E11, test type A		
Temporary	≥ 65 mm	≥ 150 mm
Permanent	≥ 65 mm	≥ 200 mm

	HCS cable for permanent indoor installation	HCS cable for permanent outdoor installation
	PSM-LWL-HCS-RUGGED-230/230	PSM-LWL-HCSO-200/230
Tensile strength, ICE 60 794-1-2, method E1		
Temporary	< 1000 N	< 1500 N
Permanent	< 200 N	< 500 N
Lateral strength, ICE 60 794-1-2, method E3		
Temporary	< 400 N/cm	< 500 N/cm
Permanent	< 100 N/cm	< 300 N/cm
Cold bend test, ISO 6722	Supporting tool \varnothing 39.5 mm, 5 kg load	-
Impact strength, ICE 60 794-1-2, method E4	2 Nm/10 impacts, maximum	1.5 Nm/3 impacts, maximum
Longitudinal water tightness, ICE 60 794-1-2, method F5, test type B	-	By swelling material 1 m cable, 1 m water column, 24 h
Resistance to abrasion, ICE 60 794-1-2, method E2, test type A	5000 cycles, minimum; 0.45 mm radius of the steel point, 7 N	-
Behavior in fire	Hardly inflammable	-
Fire load	1.72 MJ/m (0.48 kWh/m)	1.68 MJ/m (0.47 kWh/m)
Halogen-free	IEC 60754-2 A1	
Resistance to oil	ASTM oil No. 2, 100°C, according to DIN VDE 0473-811-2-1	Resistant to oil, gasoline, acids, and lyes
Chloroform test	Free from substances that would hinder coating with paint or varnish according to central standard P-VW 3.10.7 57 65 0 of VW, Audi, and Seat	
UV resistance	DIN 53387, method 1, condition A	