



User Manual

ARK-2121V

In-Vehicle HD NVR w/4 PoE Ports

ADVANTECH

Enabling an Intelligent Planet

Copyright

The documentation and the software included with this product are copyrighted 2015 by Advantech Co., Ltd. All rights are reserved. Advantech Co., Ltd. reserves the right to make improvements in the products described in this manual at any time without notice. No part of this manual may be reproduced, copied, translated or transmitted in any form or by any means without the prior written permission of Advantech Co., Ltd. Information provided in this manual is intended to be accurate and reliable. However, Advantech Co., Ltd. assumes no responsibility for its use, nor for any infringements of the rights of third parties, which may result from its use.

Acknowledgements

Intel® and Pentium® are trademarks of Intel Corporation.

Microsoft Windows® is a registered trademark of Microsoft Corp.

All other product names or trademarks are properties of their respective owners.

Product Warranty (2 years)

Advantech warrants to you, the original purchaser, that each of its products will be free from defects in materials and workmanship for two years from the date of purchase.

This warranty does not apply to any products which have been repaired or altered by persons other than repair personnel authorized by Advantech, or which have been subject to misuse, abuse, accident or improper installation. Advantech assumes no liability under the terms of this warranty as a consequence of such events.

Because of Advantech's high quality-control standards and rigorous testing, most of our customers never need to use our repair service. If an Advantech product is defective, it will be repaired or replaced at no charge during the warranty period. For out-of-warranty repairs, you will be billed according to the cost of replacement materials, service time and freight. Please consult your dealer for more details.

If you think you have a defective product, follow these steps:

1. Collect all the information about the problem encountered. (For example, CPU speed, Advantech products used, other hardware and software used, etc.) Note anything abnormal and list any onscreen messages you get when the problem occurs.
2. Call your dealer and describe the problem. Please have your manual, product, and any helpful information readily available.
3. If your product is diagnosed as defective, obtain an RMA (return merchandise authorization) number from your dealer. This allows us to process your return more quickly.
4. Carefully pack the defective product, a fully-completed Repair and Replacement Order Card and a photocopy proof of purchase date (such as your sales receipt) in a shippable container. A product returned without proof of the purchase date is not eligible for warranty service.
5. Write the RMA number visibly on the outside of the package and ship it prepaid to your dealer.

Declaration of Conformity

CE

This product has passed the CE test for environmental specifications. Test conditions for passing included the equipment being operated within an industrial enclosure. In order to protect the product from being damaged by ESD (Electrostatic Discharge) and EMI leakage, we strongly recommend the use of CE-compliant industrial enclosure products.

FCC Class A

Note: This equipment has been tested and found to comply with the limits for a Class A digital device, pursuant to part 15 of the FCC Rules. These limits are designed to provide reasonable protection against harmful interference when the equipment is operated in a commercial environment. This equipment generates, uses, and can radiate radio frequency energy and, if not installed and used in accordance with the instruction manual, may cause harmful interference to radio communications. Operation of this equipment in a residential area is likely to cause harmful interference in which case the user will be required to correct the interference at his own expense.

Technical Support and Assistance

1. Visit the Advantech web site at www.advantech.com/support where you can find the latest information about the product.
2. Contact your distributor, sales representative, or Advantech's customer service center for technical support if you need additional assistance. Please have the following information ready before you call:
 - Product name and serial number
 - Description of your peripheral attachments
 - Description of your software (operating system, version, application software, etc.)
 - A complete description of the problem
 - The exact wording of any error messages

Warnings, Cautions and Notes

Warning! *Warnings indicate conditions, which if not observed, can cause personal injury!*



Caution! *Cautions are included to help you avoid damaging hardware or losing data.*



Note! Notes provide optional additional information.



Document Feedback

To assist us in making improvements to this manual, we would welcome comments and constructive criticism. Please send all such - in writing to: support@advan-tech.com

Packing List

Before setting up the system, check that the items listed below are included and in good condition. If any item does not accord with the table, please contact your dealer immediately.

- 1 x ARK-2121V unit
- 1 x Hard copy user manual (Simplified Chinese)
- 1 x 3 pin phoenix power block 3.81mm
- 1 x GPS ANT active w/ 5M SMA cable
- 1 x 10 pin DIO plug block

Ordering Information

P/N	Description
ARK-2121V-S3A1E	Intel Atom E3825 DC 1.33 GHz w/ 4 COM
ARK-2121V-S9A1E	Intel Atom E3845 QC 1.91 GHz w/ 4 POE

Safety Instructions

1. Read these safety instructions carefully.
2. Keep this User Manual for later reference.
3. Disconnect this equipment from any AC outlet before cleaning. Use a damp cloth. Do not use liquid or spray detergents for cleaning.
4. For plug-in equipment, the power outlet socket must be located near the equipment and must be easily accessible.
5. Keep this equipment away from humidity.
6. Put this equipment on a reliable surface during installation. Dropping it or letting it fall may cause damage.
7. Do not leave this equipment in an environment unconditioned where the storage temperature under -40°C or above 80°C , it may damage the equipment. Operating temperature is -30°C to 60°C .
8. The openings on the enclosure are for air convection. Protect the equipment from overheating. **DO NOT COVER THE OPENINGS.**
9. Make sure the voltage of the power source is correct before connecting the equipment to the power outlet. Cable of Power source should be shielded.
10. Position the power cord so that people cannot step on it. Do not place anything over the power cord. The voltage and current rating of the cord should be greater than the voltage and current rating marked on the product.
11. All cautions and warnings on the equipment should be noted.
12. If the equipment is not used for a long time, disconnect it from the power source to avoid damage by transient overvoltage.
13. Never pour any liquid into an opening. This may cause fire or electrical shock.
14. Never open the equipment. For safety reasons, the equipment should be opened only by qualified service personnel.
15. If one of the following situations arises, get the equipment checked by service personnel:
 - The power cord or plug is damaged.
 - Liquid has penetrated into the equipment.
 - The equipment has been exposed to moisture.
 - The equipment does not work well, or you cannot get it to work according to the user's manual.
 - The equipment has been dropped and damaged.
 - The equipment has obvious signs of breakage.
16. **CAUTION:** The computer is provided with a battery-powered real-time clock circuit. There is a danger of explosion if battery is incorrectly replaced. Replace only with same or equivalent type recommended by the manufacture. Discard used batteries according to the manufacturers instructions.
17. **ATTENTION:** L'ordinateur est muni d'un circuit en temps réel de l'horloge alimentée par batterie. Il ya un danger d'explosion si la pile est remplacée de façon incorrecte. Remplacez uniquement par un type identique ou équivalent recommandé par le fabricant. Jetez les piles usagées selon les instructions du fabricant.

-
18. CAUTION: Always completely disconnect the power cord from your chassis whenever you work with the hardware. Do not make connections while the power is on. Sensitive electronic components can be damaged by sudden power surges.
 19. CAUTION: Always ground yourself to remove any static charge before touching the motherboard, backplane, or add-on cards. Modern electronic devices are very sensitive to static electric charges. As a safety precaution, use a grounding wrist strap at all times. Place all electronic components on a static-dissipative surface or in a static-shielded bag when they are not in the chassis.
 20. CAUTION: Any unverified component could cause unexpected damage. To ensure the correct installation, please always use the components (ex. screws) provided with the accessory box.
 21. ATTENTION: Tout composant non vérifiée pourrait causer des dommages inattendu. Pour garantir une installation correcte, s'il vous plaît utilisez toujours les composants(vis ex.) fournies avec la boîte d'accessories.

Contents

Chapter 1	General Introduction	1
1.1	Introduction	2
1.2	General Specification	3
1.3	Specifications	3
	Table 1.1: Power Input / Output support information	4
1.4	Dimensions	5
	Figure 1.1 ARK-2121V dimensions	5
Chapter 2	Hardware installation	7
2.1	Overview of Hardware Installation & Upgrading	8
2.2	Installing Memory	8
2.3	Installing storage	9
	2.3.1 Installing 2.5" SSD or HDD	9
	2.3.2 Installing mSATA Storage	9
2.4	Installing Optional Modules	10
	2.4.1 Installing WLAN module	10
	2.4.2 Installing WWAN module	11
Chapter 3	Jumper and Switch Settings	13
3.1	Setting Jumpers and Switches	14
3.2	Locations of Jumpers	14
	3.2.1 Main board	14
	Figure 3.1 Top side of main board	14
	3.2.2 I/O board (ARK-2121V-S3A1E Only)	15
	Figure 3.2 Top side of I/O board	15
	Figure 3.3 Bottom side of I/O board	15
	3.2.3 I/O board (ARK-2121V-S9A1E Only)	16
	Figure 3.4 Bottom side of I/O board	16
	3.2.4 3.2.4. Power board	16
	Figure 3.5 Top side of power board	16
3.3	Jumper Lists	17
	3.3.1 Main Board	17
	Table 3.1: Jumpers & Switches	17
	3.3.2 I/O Board (ARK-2121V-S3A1E Only)	17
	Table 3.2: Jumper List	17
	3.3.3 I/O Board (ARK-2121V-S9A1E Only)	17
	Table 3.3: Jumper List	17
	3.3.4 Power Board	17
	Table 3.4: Jumper List	17
3.4	Jumper Settings	18
	3.4.1 Main Board	18
	Table 3.5: Auto Power On Setting (J2)	18
	Table 3.6: LCD Power (J5)	18
	Table 3.7: Clear CMOS (SW2)	18
	3.4.2 I/O Board (ARK-2121V-S3A1E Only)	19
	Table 3.8: RS232/422/485 Setting	19
	3.4.3 RS232/422/485 Jumper Setting – COM2 (J2)	19
	Table 3.9: RS232/422/485 Setting	19
	Table 3.10: WWAN Voice Audio –PCM Data In/Out Swap	19
	Table 3.11: WWAN Module Power Selection	20
	3.4.4 I/O Board (ARK-2121V-S9A1E Only)	20

	Table 3.12: WWAN Voice Audio –PCM Data In/Out Swap	20
	Table 3.13: WAN Module Power Selection	20
3.4.5	Power Board	21
	Table 3.14: Power Ignition HW Setting	21
	Table 3.15: Power Ignition SW/HW Setting Selection	22

Chapter 4 Pin Assignments 23

4.1	ARK-2121V-S3A1E I/O Connectors	24
4.1.1	ARK-2121V-S3A1E Front I/O View	24
4.1.2	ARK-2121V-S3A1E Rear I/O View	24
4.2	ARK-2121V-S3A1E I/O Pin Definition.....	24
4.2.1	VGA Connector.....	24
	Figure 4.1 VGA Connector	24
	Table 4.1: VGA Connector Pin Assignments	24
4.2.2	USB Connector.....	25
	Figure 4.2 USB Connector [Upper (black): USB2.0 / Down (blue): USB 3.0].....	25
	Table 4.2: USB Connector Pin Assignments.....	25
4.2.3	Ethernet Connector.....	25
	Figure 4.3 Ethernet Connector	25
	Table 4.3: Ethernet Connector Pin Assignments	25
4.2.4	HDMI Connector.....	26
	Figure 4.4 HDMI Connector.....	26
	Table 4.4: HDMI / Display Port Connector Pin Assignments	26
4.2.5	DIO Connector.....	26
	Figure 4.5 DIO Connector	26
4.2.6	Power Input Connector.....	27
	Figure 4.6 Power Input Connector.....	27
4.2.7	COM Connector.....	27
	Figure 4.7 COM Port Connector.....	27
	Table 4.5: COM Connector Pin Assignments.....	27
4.2.8	System Audio Connector.....	28
	Figure 4.8 System Audio Connector.....	28
	Table 4.6: Audio Connector Pin Assignments.....	28
4.2.9	Cellular Voice Connector.....	28
	Figure 4.9 Cellular Voice Connector.....	28
	Table 4.7: Cellular Voice Connector Pin Assignments.....	28
4.2.10	Optional I/O.....	28
4.2.11	Power Input Mode.....	29
	Figure 4.10 Power Input Mode	29
4.2.12	Power On/Off Button.....	29
	Figure 4.11 Power ON/OFF Button	29
4.2.13	Reset	29
	Figure 4.12 Reset	29
4.2.14	LED Indicator	29
	Figure 4.13 LED Indicator.....	29
4.3	ARK-2121V-S9A1E I/O Connectors	30
4.3.1	ARK-2121V-S9A1E Front I/O View	30
4.3.2	ARK-2121V-S9A1E Rear I/O View	30
4.4	ARK-2121V-S9A1E I/O Pin Definition.....	30
4.4.1	VGA Connector.....	30
	Figure 4.14 VGA Connector	30
	Table 4.8: VGA Connector Pin Assignments	30
4.4.2	USB Connector.....	31
	Figure 4.15 USB Connector [Upper (black): USB2.0 / Down (blue): USB 3.0].....	31
	Table 4.9: USB Connector Pin Assignments.....	31
4.4.3	Ethernet Connector.....	31

	Figure 4.16 Ethernet Connector	31
	Table 4.10: Ethernet Connector Pin Assignments	31
4.4.4	HDMI Connector	32
	Figure 4.17 HDMI Connector	32
	Table 4.11: HDMI / Display Port Connector Pin Assignments	32
4.4.5	DIO Connector	32
	Figure 4.18 DIO Connector	32
4.4.6	Power Input Connector	33
	Figure 4.19 Power Input Connector	33
4.4.7	Power Over Ethernet	33
	Figure 4.20 Power Over Ethernet Connector	33
	Table 4.12: Power Over Ethernet (PoE) Pin Definition	33
4.4.8	System Audio Connector	33
	Figure 4.21 System Audio Connector	33
	Table 4.13: Audio Connector Pin Assignments	34
4.4.9	Cellular Voice Connector	34
	Figure 4.22 Cellular Voice Connector	34
	Table 4.14: Cellular Voice Connector Pin Assignments	34
4.4.10	Optional I/O	34
4.4.11	Power Input Mode	34
	Figure 4.23 Power Input Mode	34
4.4.12	Power On/Off Button	35
	Figure 4.24 Power ON/OFF Button	35
4.4.13	Reset	35
	Figure 4.25 Reset	35
4.4.14	LED Indicator	35
	Figure 4.26 LED Indicator	35

Chapter 5 BIOS settings37

5.1	Introduction	38
	Figure 5.1 Setup program initial screen	38
5.2	Entering Setup	39
5.2.1	Main Setup	39
	Figure 5.2 Main setup screen	39
5.2.2	Advanced BIOS Features Setup	40
	Figure 5.3 Advanced BIOS features setup screen	40
5.2.3	Chipset Configuration	52
5.2.4	Security	58
5.2.5	Boot	59
5.2.6	Save & Exit	60

Appendix A WDT Sample Code61

A.1	Watchdog Timer Sample Code	62
-----	----------------------------------	----

Chapter 1

General Introduction

This chapter gives background information on ARK-2121V series.

1.1 Introduction

ARK-2121V is an industrial grade dual core mobile device for in vehicle computer and in vehicle NVR solution.

ARK-2121V support HD NVR solutions and is fully integrated certified hardware and intelligent management software design. ARK-2121V integrated in-vehicle power (ISO-7637-2), in-vehicle certifications (E-Mark, IEC-60721-3-5 5M3) and well-developed vehicle software SDK and APIs for in-vehicle applications. They also provided extension capability and wireless communication (GPS/G-sensor/Wi-Fi/3G/CANBus) for excellent connectivity, high graphic power (Up to 1080p @120fps) for video preview, and integrated software for manageability and security.

ARK-2121V-S3A1E I/O Overview

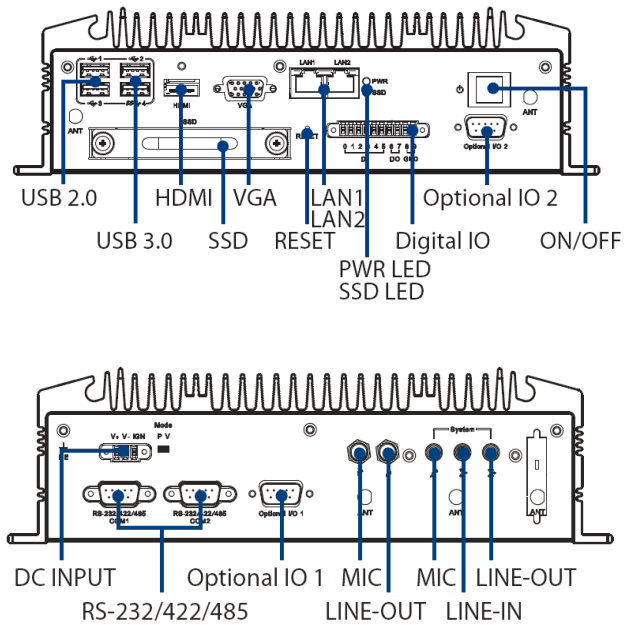

ARK-2121V-S9A1E I/O Overview

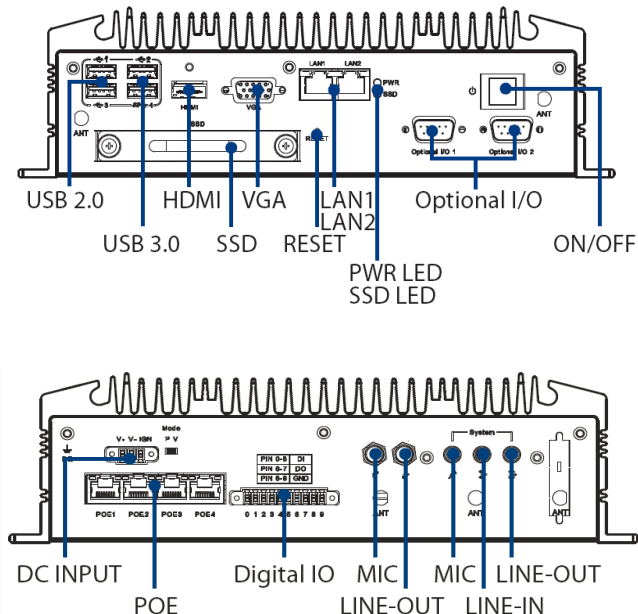

1.2 General Specification

- Intel® Celeron E3825 1.33GHz / E3845 1.91 GHz SoC
- 4 PoE ports to support mainstream IP cameras
- Diverse communication abilities: WWAN, WLAN
- Built-in GPS and G-Sensor for GIS application
- Intelligent vehicle power ignition
- 9 ~ 36*Vdc wide power input w/isolation
(*Power input constraint at low power 9 ~ 10.9 V)
- Dual storage: 1 x 2.5" removable drive bay & 1 x F/S mSATA
- Supports iManager, SUSIAccess and embedded software APIs

1.3 Specifications

- **CPU:**
 - ARK-2121V-S3A1E: Intel Celeron E3825 DC 1.33GHz
 - ARK-2121V-S9A1E: Intel Core E3845 QC 1.91GHz
- **Chipset:**
 - ARK-2121V-S3A1E: Intel Gen7 graphics
 - ARK-2121V-S9A1E: Intel Gen7 graphics
- BIOS: AMI EFI 64 Mbit
- **System memory:**
 - ARK-2121V-S3A1E: 1 x 204pin SODIMM, DDR3L 1066 MHz, up to 8GB
 - ARK-2121V-S9A1E: 1 x 204pin SODIMM, DDR3L 1333 MHz, up to 8GB
- **Storage:**
 - 2.5" drive bay: 1 x 2.5" removable drive bay (Max 9.5mm height)
 - mSATA: 1x full size mSATA storage
- **Serial ports:**
 - ARK-2121V-S3A1E: 2 x RS-232/422/485 ports w/ 3KV isolation (support auto flow control, jumper selectable)
- **Optional I/O:**
 - ARK-2121V-S3A1E: 2 x CANBus 2.0 A/B or 2 x RS-232/422/485
 - ARK-2121V-S9A1E: 2 x CANBus 2.0 A/B or 2 x RS-232/422/485
- **Universal serial bus (USB) port:** 3 x USB 2.0 & 1 x USB3.0
- **LAN port:** 2 x Giga LAN 10/100/1000Mbps, support wake on LAN
- **Power over Ethernet, POE (ARK-2121V-S9A1E only):**
 - Supports 4 x 10/100 Mbps
 - 4 ports full-load, IEEE802.3af Class 2 (7Watt)
 - 2 ports full-load, IEEE802.3af Class 3 (15.4Watt)
- **LED:** Power LED, SSD LED
- **Graphic output:**
 - 1 x VGA, up to 2560 x 1600 with 60 Hz
 - 1 x lockable HDMI connector, up to 1080p
- **Mini PCI express bus expansion slot:**
 - 1 x full size mini PCIe slot, support mSATA storage
 - 1 x full size mini PCIe slot, support WLAN module
 - 2 x full size mini PCIe slots w/SIM holder, support WWAN module (USB interface)

- **Watchdog timer:** 255-level timer interval, setup by software
- **RTC Battery:** 3.0 V @ 200 mAH Lithium battery.
- **Digital I/O:** 6 x DI & 2 x DO w/ 3KV isolation
 - Input Voltage: 0 to 30 VDC at 25 Hz
 - Digital Input Levels for Dry Contacts:
 - Logic level 0: Close to GND
 - Logic level 1: Open
 - Digital Input Levels for Wet Contacts:
 - Logic level 0: +3 V max
 - Logic level 1: +5 V to +30 V
 - Output Current: Max. 500 mA per channel
 - On-state Voltage: 24 VDC nominal, open collector to 30 VDC
- **Audio:**
 - Main system: Realtek ALC888S, High Definition Audio (HD), Line-in, Line out, Mic-in
 - Cellular Voice: Supports WWAN voice function, Line-out, Mic-in
- **GPS:** On board standalone GPS, supports GPS, GLONASS and QZSS signals
- **G-sensor:** On board high resolution G-Sensor, up to 13-bit resolution at ±16g
- **Power Requirement:**
 - Power type: ATX/AT
 - Input voltage: Supports: 9~36 VDC*
 - *Power input voltage constraint at lower voltage 9 ~ 10.9 V
 - Vehicle power ignition: selection boot up & shut-down voltage, on/off delay time
 - Isolation: 1.5 KV Isolated

Table 1.1: Power Input / Output support information

	Output: 12 V (for M/B)	Output: 48 V (for PoE)
Input 11 V ~ 36 V	5 A	0.75 A
Input 10.0 V ~ 10.9 V	4 A	0.5 A
Input 9.0 V ~ 9.9 V	3.5 A	N/A

- **Dimensions: (W x H x D):** 264.5 x 69.2 x 133.0 mm (10.41" x 2.96" x 5.24")
- **Enclosure:** Ruggedized aluminum housing.
- **Operating temperature:**
 - ARK-2121V-S3A1E:
 - With extended temperature peripherals:-30 ~ 70° C with 0.7m/s air flow
 - With standard temperature peripherals: 0 ~ 45° C with 0.7m/s air flow
 - ARK-2121V-S9A1E:
 - With extended temperature peripherals:-30 ~ 60° C with 0.7m/s air flow
 - With standard temperature peripherals: 0 ~ 45° C with 0.7m/s air flow
- **Storage temperature:** -40 ~ 85° C (-40~185° F)
- **Relative humidity:** 95% @ 40° C (non-condensing)
- **Vibration / Shock:** With mSATA/SSD: IEC 60721-3-5 Class 5M3
- **Certifications:**
 - EMC: CE/FCC Class A, CCC, BSMI
 - Safety: UL, CCC, BSMI, E-Mark (E13)
 - In-Vehicle Power: ISO7637-2 Lev.4

1.4 Dimensions

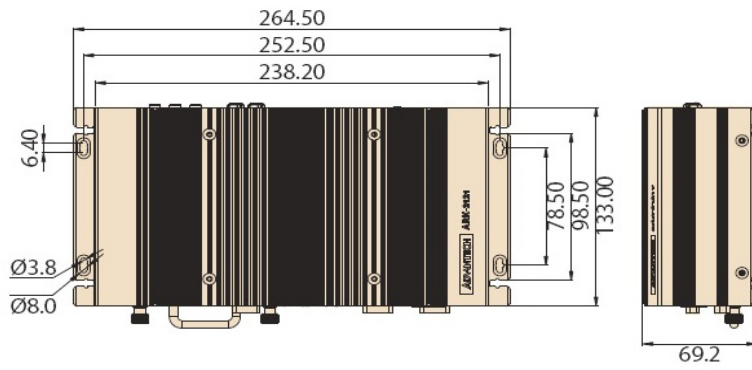

Figure 1.1 ARK-2121V dimensions

Chapter 2

Hardware installation

This chapter introduces the installation of ARK-2121V Hardware.

2.1 Overview of Hardware Installation & Upgrading

Warning! Do not remove the ruggedized aluminum covers until verifying that no power is flowing within the computer. Power must be switched off and the power cord must be unplugged. Take care in order to avoid injury or damage to the equipment.



2.2 Installing Memory

Need to remove total 9pcs screws and can install memory on the top side of board. (4pcs on top and 5pcs on side of top cover)

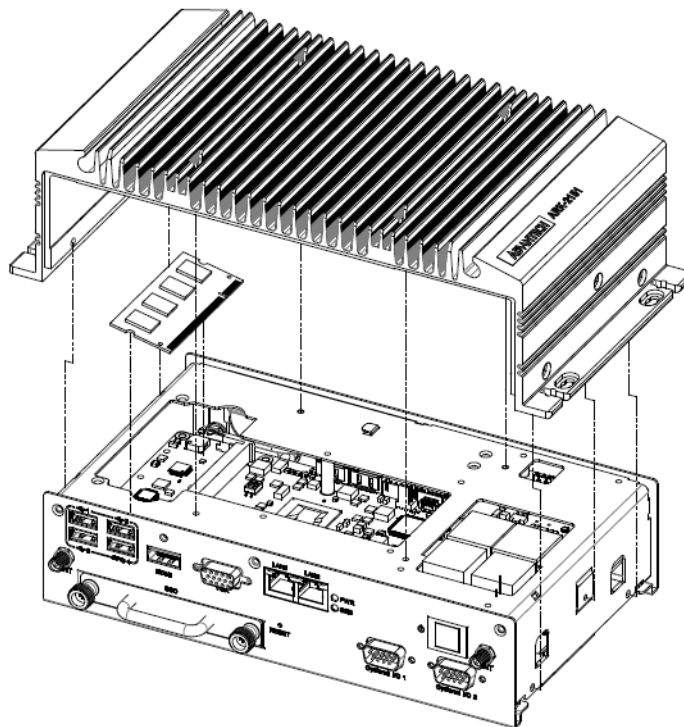

2.3 Installing storage

2.3.1 Installing 2.5" SSD or HDD

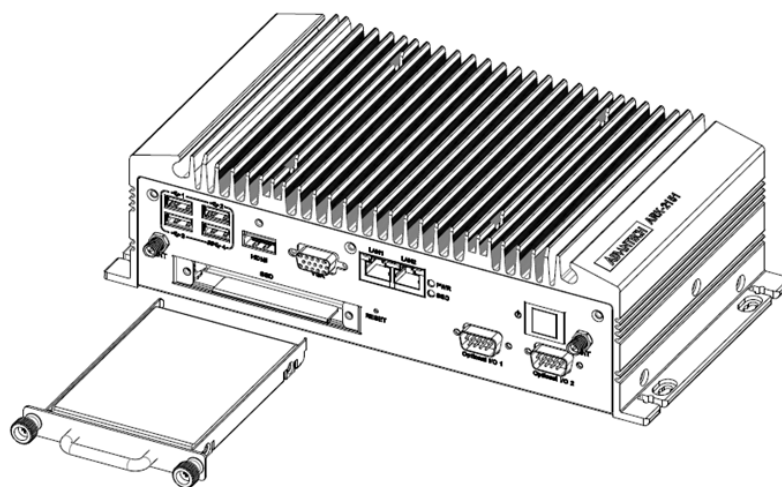

2.3.2 Installing mSATA Storage

1. Remove 6pcs screws on bottom cover.

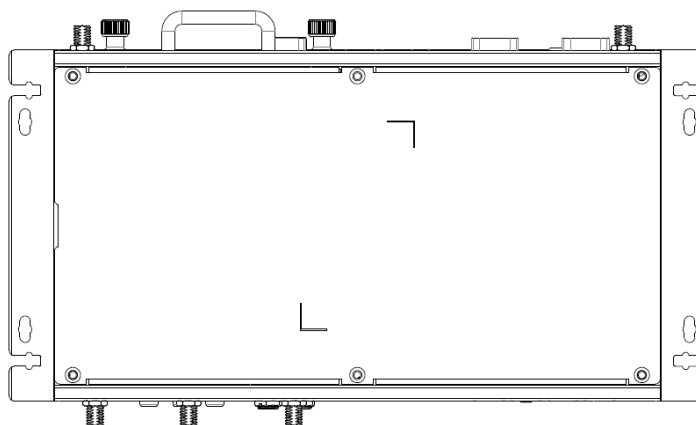

2. Remove 2.5" drive bay and Insert full size mSATA storage in marked place.

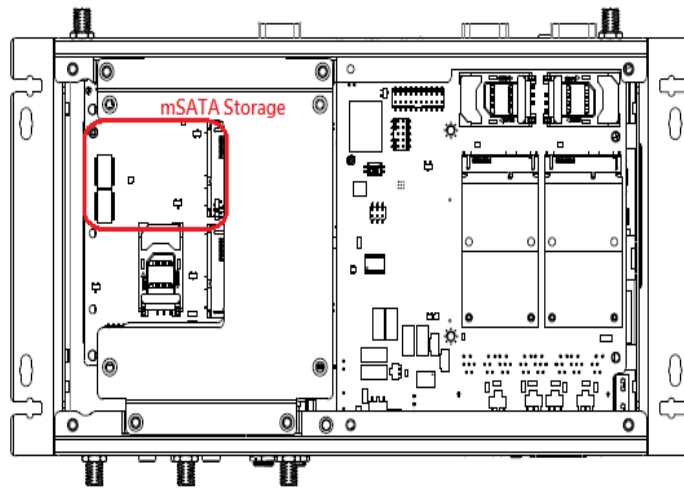

2.4 Installing Optional Modules

2.4.1 Installing WLAN module

1. Remove 6pcs screws on bottom cover.

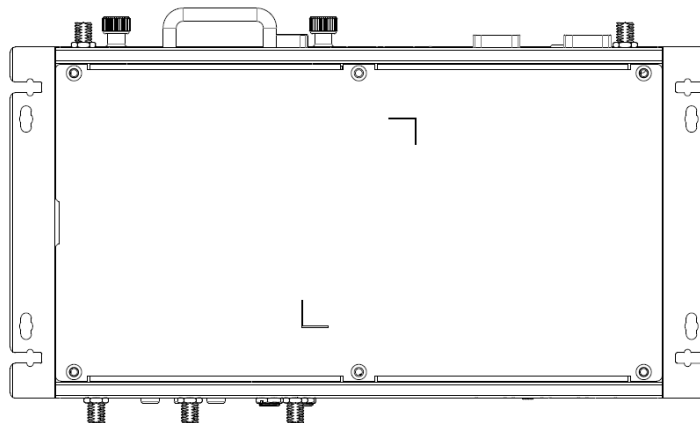

2. Remove 2.5" drive bay and Insert half size WLAN module in marked place.

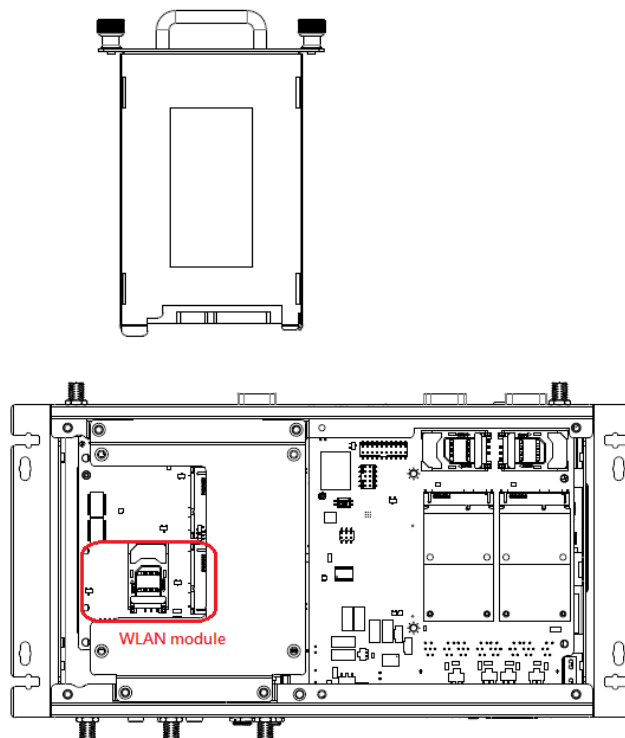

2.4.2 Installing WWAN module

1. Remove 6pcs screws on bottom cover.

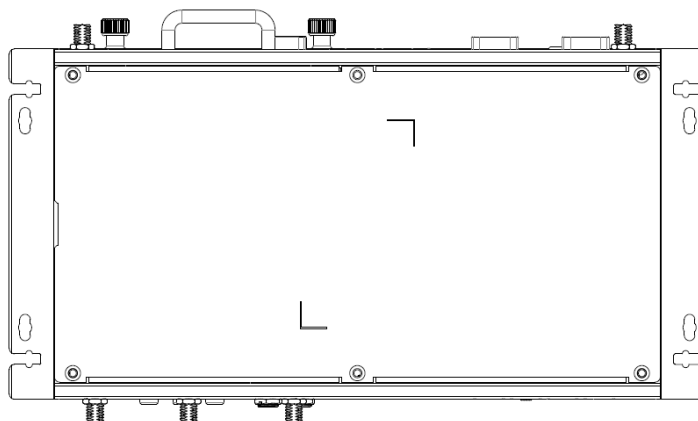

2. Remove 2.5" drive bay and Insert full size WWAN module in marked place.

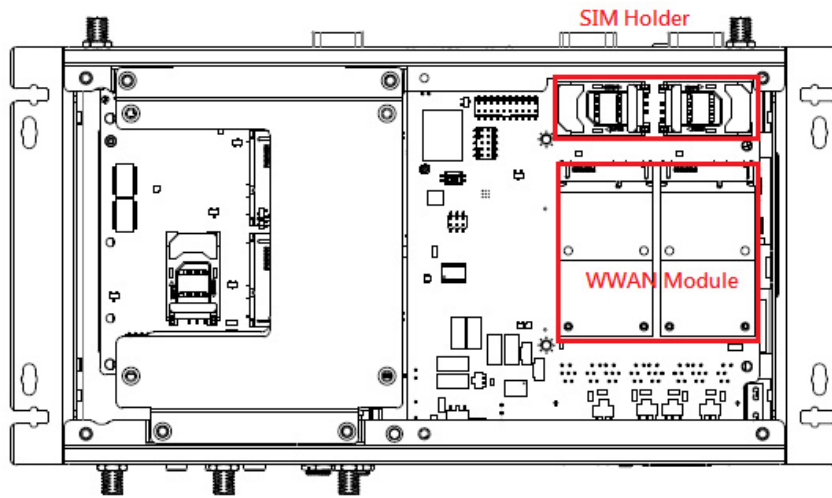

Chapter 3

Jumper and Switch Settings

This chapter explains how to set up ARK-2121V Series hardware, including instructions on setting jumpers and connecting peripherals, and how to set switches and read indicators.

Be sure to read all the safety precautions before beginning the installation procedure.

3.1 Setting Jumpers and Switches

It is possible to configure the In-Vehicle Computing Box to match the needs of the application by resetting the jumpers. A jumper is the simplest kind of electrical switch. It consists of two metal pins and a small metal clip, often protected by a plastic cover that slides over the pins to connect them. To “close” a jumper, connect the pins with the clip. To “open” a jumper, remove the clip. Sometimes a jumper has three pins, labeled 1, 2, and 3. In this case, connect either pins 1 and 2, or pins 2 and 3.

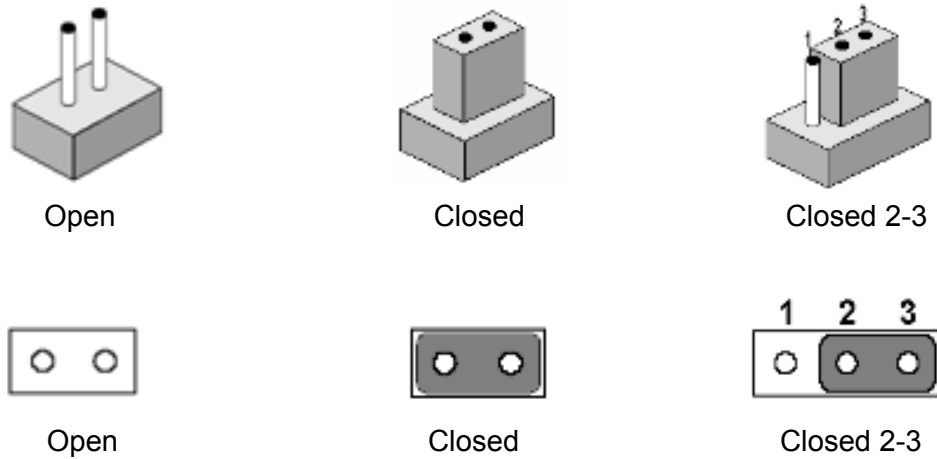

A pair of needle-nose pliers may be helpful when working with jumpers. If there are any doubts about the best hardware configuration for the application, contact the local distributor or sales representative before making any changes.

An arrow is used on the motherboard to indicate the first pin of each jumper.

3.2 Locations of Jumpers

3.2.1 Main board

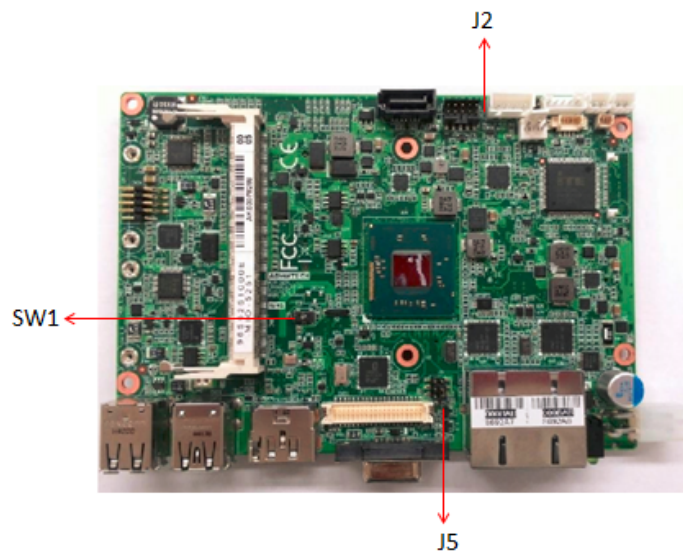

Figure 3.1 Top side of main board

3.2.2 I/O board (ARK-2121V-S3A1E Only)

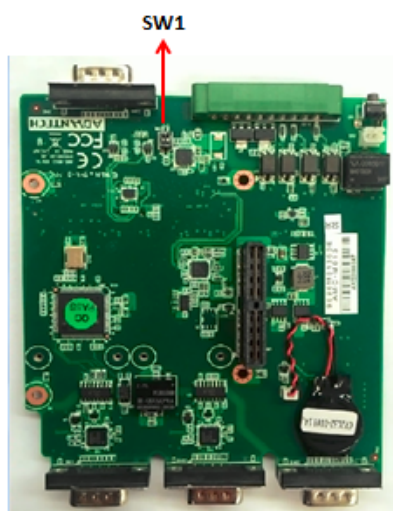

Figure 3.2 Top side of I/O board

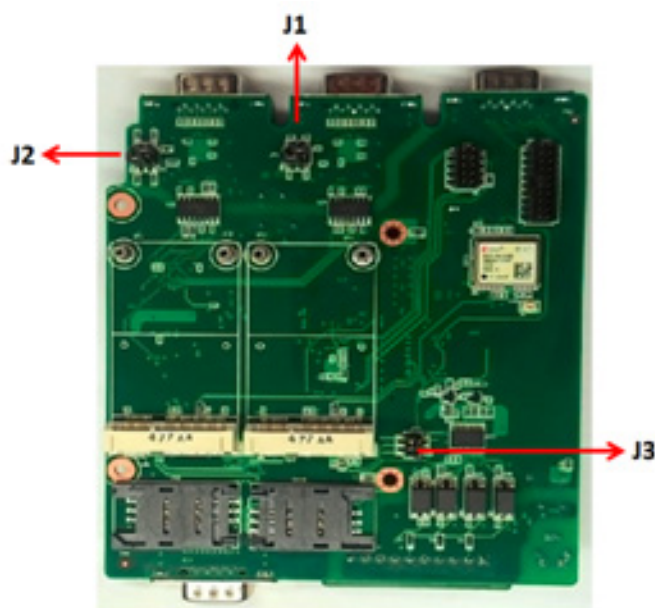

Figure 3.3 Bottom side of I/O board

3.2.3 I/O board (ARK-2121V-S9A1E Only)

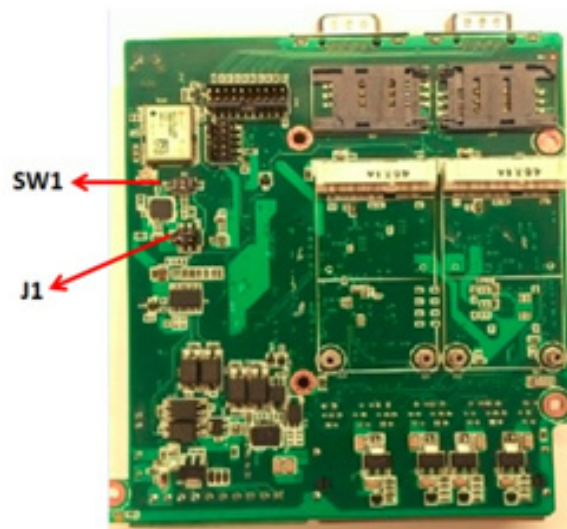

Figure 3.4 Bottom side of I/O board

3.2.4 3.2.4. Power board

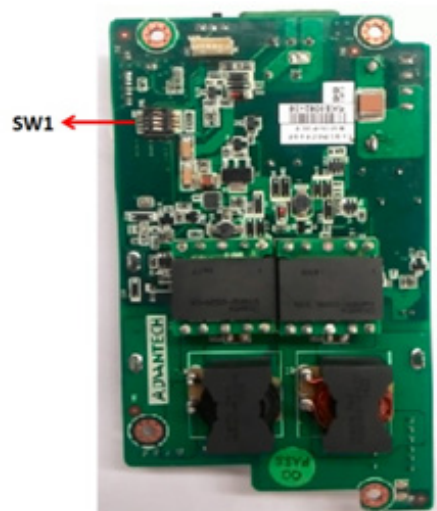

Figure 3.5 Top side of power board

3.3 Jumper Lists

3.3.1 Main Board

Table 3.1: Jumpers & Switches

J2	Auto Power On
J5	LCD Power
SW2	Clear CMOS

3.3.2 I/O Board (ARK-2121V-S3A1E Only)

Table 3.2: Jumper List

J1	RS232/422/485 Jumper Setting – COM2
J2	RS232/422/485 Jumper Setting – COM1
J3	WWAN Voice audio – PCM data in/out swap
SW1	WWAN module Power Selection

3.3.3 I/O Board (ARK-2121V-S9A1E Only)

Table 3.3: Jumper List

J1	WWAN Voice audio – PCM data in/out swap
SW1	WWAN module Power Selection

3.3.4 Power Board

Table 3.4: Jumper List

SW1	Power Ignition HW Setting
-----	---------------------------

3.4 Jumper Settings

3.4.1 Main Board

3.4.1.1 Auto Power On Setting (J2)

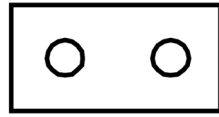

OPEN

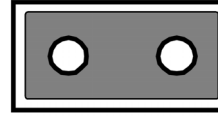

Closed

Table 3.5: Auto Power On Setting (J2)

Setting	Function
(Open)	Power Button for Power On
(Close)*	Auto Power On

* Default

3.4.1.2 LCD Power (J5)

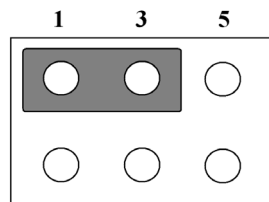

Table 3.6: LCD Power (J5)

Setting	Function
(1-3)*	+3.3V
(3-5)	+5V
(3-4)	+12V

3.4.1.3 Clear CMOS (SW2)

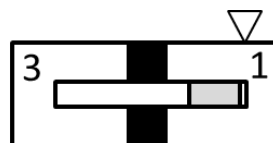

Table 3.7: Clear CMOS (SW2)

Setting	Function
(1)*	Normal
(3)	Clear CMOS

3.4.2 I/O Board (ARK-2121V-S3A1E Only)

3.4.2.1 RS232/422/485 Jumper Setting – COM1 (J1)

(1-3), (4-6) * (1-3), (2-4) (3-5), (2-4)

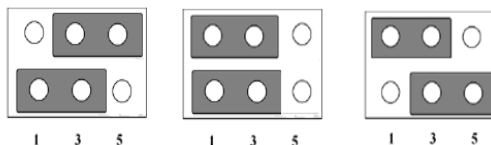

Table 3.8: RS232/422/485 Setting

Setting	Function
(1-3), (4-6) *	RS-232
(1-3), (2-4)	RS-422
(3-5), (2-4)	RS-485

3.4.3 RS232/422/485 Jumper Setting – COM2 (J2)

(1-3), (4-6) * (1-3), (2-4) (3-5), (2-4)

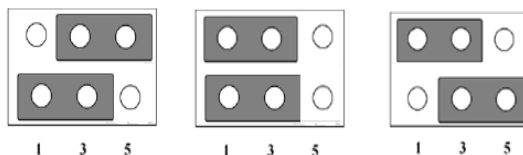

Table 3.9: RS232/422/485 Setting

Setting	Function
(1-3), (4-6) *	RS-232
(1-3), (2-4)	RS-422
(3-5), (2-4)	RS-485

3.4.3.1 WWAN Voice audio – PCM data in/out swap (J3)

(1-3), (4-6) * (3-5), (2-4)



Table 3.10: WWAN Voice Audio –PCM Data In/Out Swap

Setting	Function
(1-3), (4-6) *	PCM_IN → PCMA_OUT; PCM_OUT → PCMA → IN
(3-5), (2-4)	PCM_IN → PCMA_IN; PCM_OUT → PCMA → Out

3.4.3.2 WWAN module Power Selection (SW1)

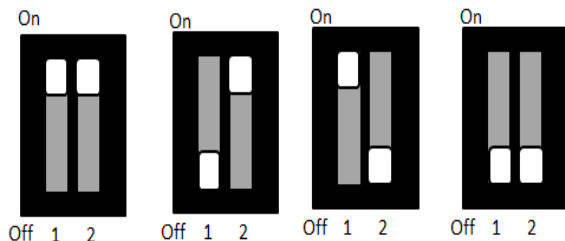

Table 3.11: WWAN Module Power Selection

Setting	Function
1(On), 2 (On)	3.6V
1(Off), 2 (On)	3.5V
1(On), 2 (Off)	3.4V
1(Off), 2 (Off)*	3.3V

3.4.4 I/O Board (ARK-2121V-S9A1E Only)

3.4.4.1 WWAN Voice audio – PCM data in/out swap (J1)

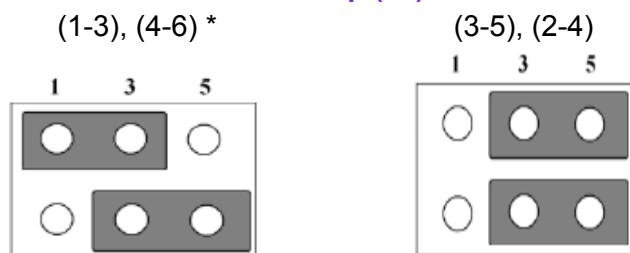

Table 3.12: WWAN Voice Audio –PCM Data In/Out Swap

Setting	Function
(1-3), (4-6) *	PCM_IN → PCMA_OUT; PCM_OUT→PCMA→IN
(3-5), (2-4)	PCM_IN → PCMA_IN; PCM_OUT→PCMA→Out

3.4.4.2 WWAN module Power Selection (SW1)

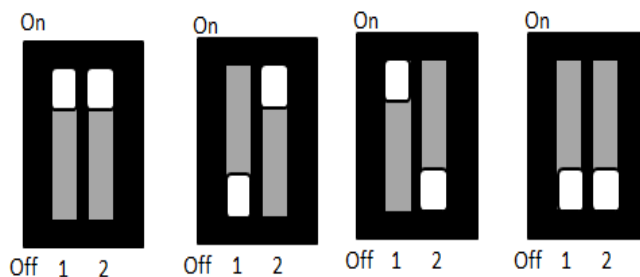

Table 3.13: WAN Module Power Selection

Setting	Function
1(On), 2 (On)	3.6V
1(Off), 2 (On)	3.5V

Table 3.13: WAN Module Power Selection

1(On), 2 (Off)	3.4V
1(Off), 2 (Off)*	3.3V

3.4.5 Power Board

3.4.5.1 Power Ignition HW Setting (SW1_1-3)

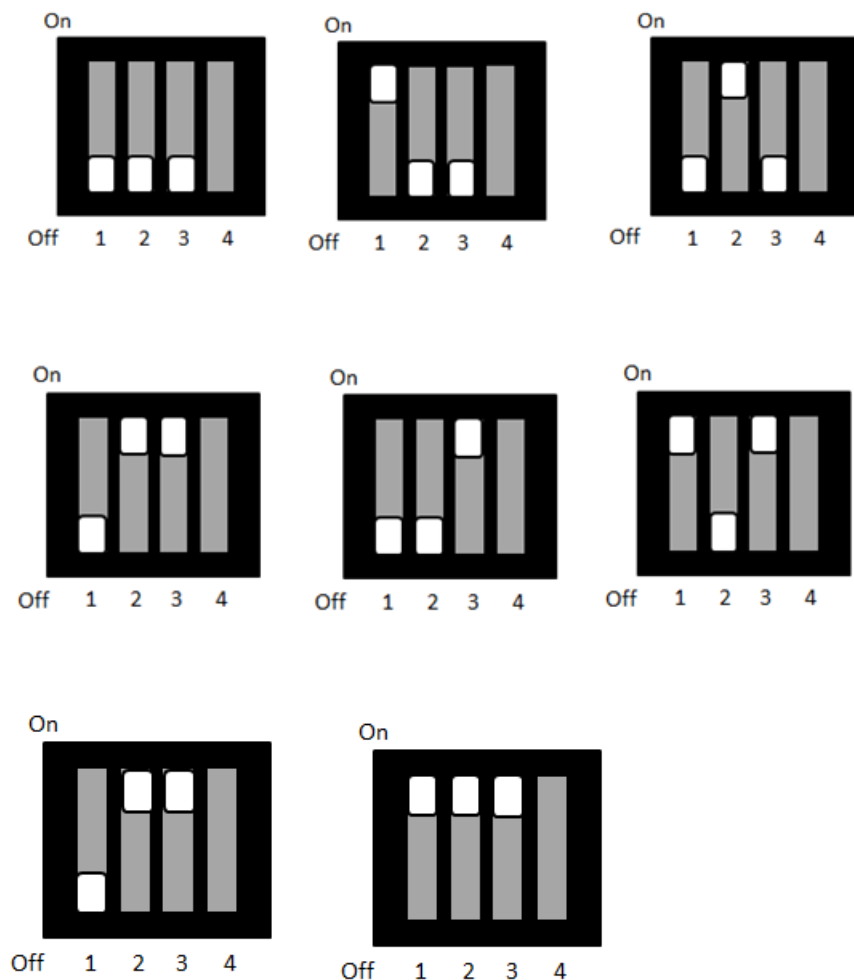

Table 3.14: Power Ignition HW Setting

Setting			Function		
1	2	3	Ignition on Timer	Ignition Delay off Timer	Ignition Hard off Timer
Off*	Off*	Off*	7	30	180
On	Off	Off	10	40	180
Off	On	Off	10	60	180
Off	On	On	30	60	180
Off	Off	On	60	120	180
On	Off	On	120	180	180
Off	On	On	180	240	180
On	On	On	7	0	180

3.4.5.2 Power Ignition SW/HW Setting (SW1_4)

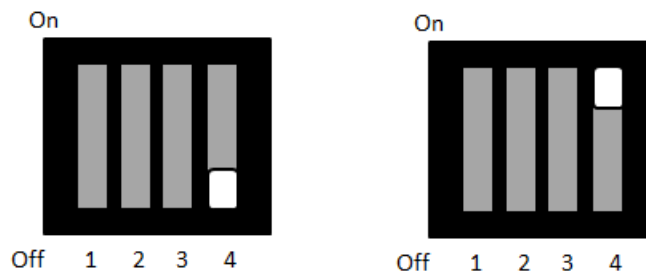

Table 3.15: Power Ignition SW/HW Setting Selection

Setting	Function
Off*	Power Ignition SW setting
On	Power Ignition HW setting

Chapter 4

Pin Assignments

This chapter explains Pin Assignments of ARK-2121V Series.

4.1 ARK-2121V-S3A1E I/O Connectors

4.1.1 ARK-2121V-S3A1E Front I/O View

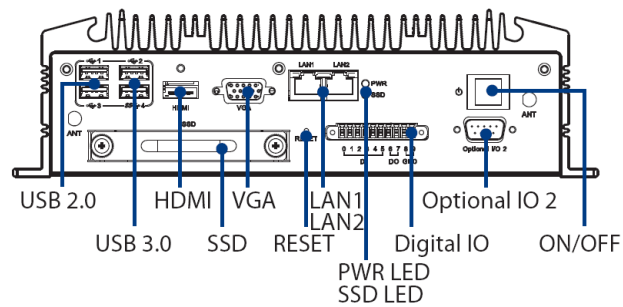

4.1.2 ARK-2121V-S3A1E Rear I/O View

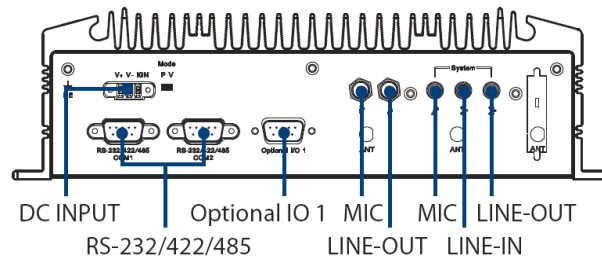

4.2 ARK-2121V-S3A1E I/O Pin Definition

4.2.1 VGA Connector

The ARK-2121V provides a high resolution VGA interface connected by a D-sub 15-pin connector to support a VGA CRT monitor. It supports display resolution of up to 1920 x 1200 with 60 Hz.

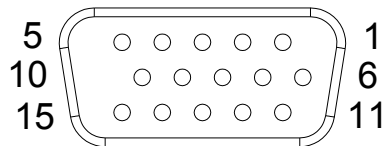

Figure 4.1 VGA Connector

Table 4.1: VGA Connector Pin Assignments

Pin	Signal Name	Pin	Signal Name
1	Red	2	Green
3	Blue	4	NC
5	GND	6	GND
7	GND	8	GND
9	NC	10	GND
11	NC	12	DDC Date
13	H-SYNC	14	V-SYNC
15	DDC Clock		

4.2.2 USB Connector

The ARK-2121V provides up to four USB interface connectors - 3 x USB 2.0 & 1 x USB 3.0, which give complete Plug & Play. The USB interface is compliant with USB UHCI, Rev. 2.0 & 3.0. The USB interface supports Plug and Play, which enables you to connect or disconnect a device whenever you want, without turning off the computer.

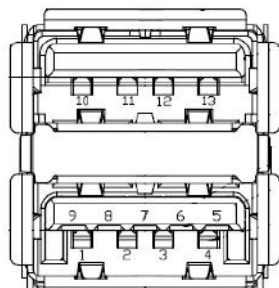

Figure 4.2 USB Connector [Upper (black): USB2.0 / Down (blue): USB 3.0]

Table 4.2: USB Connector Pin Assignments

Pin	Signal Name	Pin	Signal Name
1	+5V	2	D-
3	D+	4	GND
5	SSRX-	6	SSRX+
7	GND	8	SSTX-
9	SSTX+	10	+5V
11	D-	12	D+
13	GND		

4.2.3 Ethernet Connector

ARK-2121V provides two RJ45 LAN interface connectors, which are fully compliant with IEEE 802.3u 10/100/1000 Base-T CSMA/CD standards. LAN1 is equipped with Intel I218 GbE and LAN2 is equipped with Intel I210 GbE. The Ethernet ports use standard RJ-45 jack connectors with LED indicators on the front side to show Active/Link status and Speed status.

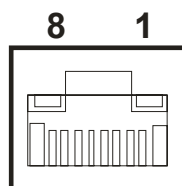

Figure 4.3 Ethernet Connector

Table 4.3: Ethernet Connector Pin Assignments

Pin	Signal Name	Pin	Signal Name
1	TX+(10/100),BI_DA+(GHz)	5	BI_DC-(GHz)
2	TX-(10/100),BI_DA-(GHz)	6	RX-(10/100),BI_DB-(GHz)
3	RX+(10/100),BI_DB+(GHz)	7	BI_DD+(GHz)
4	BI_DC+(GHz)	8	BI_DD-(GHz)

4.2.4 HDMI Connector

ARK-2121V provides 1 x lockable HDMI port which resolution can support up to 1080P.

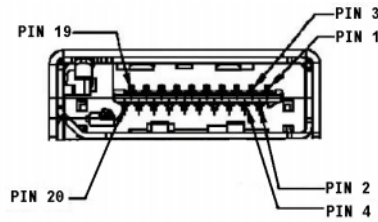

Figure 4.4 HDMI Connector

Table 4.4: HDMI / Display Port Connector Pin Assignments

Pin	Signal Name	Pin	Signal Name
1	TMDS_Data2+/ DP_Data0+	2	GND
3	TMDS_Data2-/ DP_Data0-	4	TMDS_Data1+/ DP_Data1+
5	GND	6	TMDS_Data1-/ DP_Data1-
7	TMDS_Data0+/ DP_Data2+	8	GND
9	TMDS_Data0-/ DP_Data2-	10	TMDS_Clock+/ DP_Data3+
11	GND	12	TMDS_Clock-/ DP_Data3-
13	NC	14	NC
15	SCL/ AUX_CH+	16	SDA/ GND
17	DDC GND/ AUX_CH-	18	+5V/ Hot plug detect
19	Hot plug detect/ Return	20	DP_PWR

4.2.5 DIO Connector

ARK-2121V offers an 8-bit phenix type DIO connector and two ground pin. 6 x DI & 2 x DO w/ 3 KV isolation.

- **Connector Type:** 10-pin screw terminal block (6 DI points, 2 DO points, GND)
- **Input Voltage:** 0 to 30 VDC at 25 Hz
- **Digital Input Levels for Dry Contacts:**
Logic level 0: Close to GND
Logic level 1: Open
- **Digital Input Levels for Wet Contacts:**
Logic level 0: +3 V max
Logic level 1: +5 V to +30 V
- **Output Current:** Max. 500 mA per channel
- **On-state Voltage:** 24 VDC nominal, open collector to 30 VDC

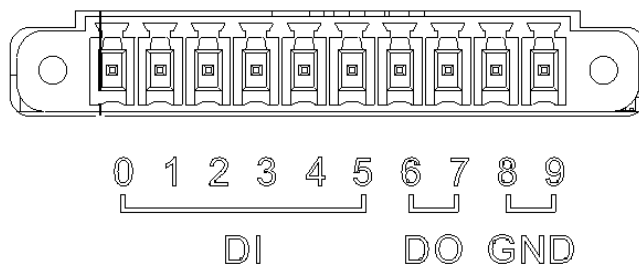

Figure 4.5 DIO Connector

4.2.6 Power Input Connector

ARK-2121V comes with 3-pin phenix type power input connector for 9 ~ 36 VDC input.

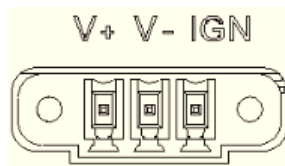

Figure 4.6 Power Input Connector

4.2.7 COM Connector

ARK-2121V-S6A1E provides two D-sub 9-pin connectors, which offers 2 x RS-232/422/485 serial communication ports w/ 3 KV isolation. (Jumper setting selectable)

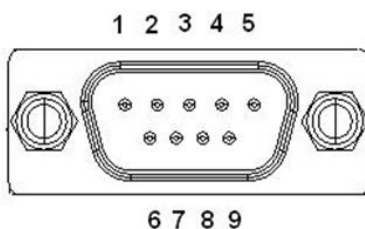

Figure 4.7 COM Port Connector

Table 4.5: COM Connector Pin Assignments

	RS-232	RS-422	RS-485
Pin	Signal Name	Signal Name	Signal Name
1	DCD	Tx-	DATA-
2	RxD	Tx+	DATA+
3	TxD	Rx+	NC
4	DTR	Rx-	NC
5	GND	GND	GND
6	DSR	NC	NC
7	RTS	NC	NC
8	CTS	NC	NC
9	RI	NC	NC

4.2.8 System Audio Connector

ARK-2121V offers stereo audio ports by a phone jack connector of Line-out, Mic-in & Line-in. The audio chip controller is by Realtek ALC888, High Definition Audio.

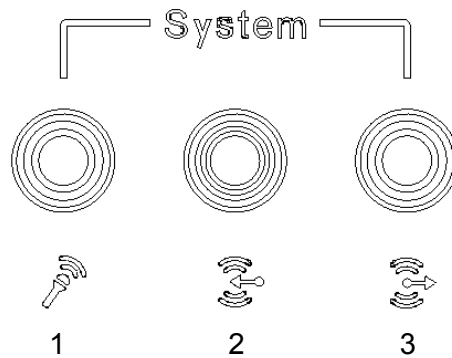

Figure 4.8 System Audio Connector

Table 4.6: Audio Connector Pin Assignments

Pin	Audio Signal Name
1	MIC
2	Line-In
3	Line-Out

4.2.9 Cellular Voice Connector

ARK-2121V offers stereo audio ports by a phone jack connector of Line-out & Mic-in.

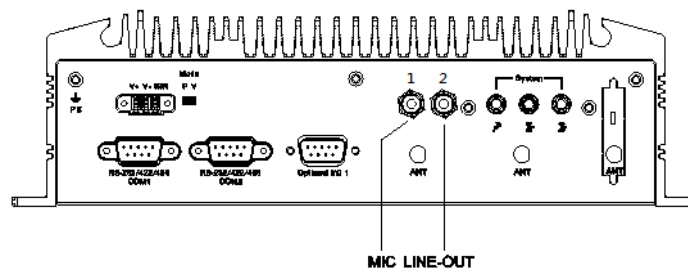

Figure 4.9 Cellular Voice Connector

Table 4.7: Cellular Voice Connector Pin Assignments

Pin	Cellular Signal Name
1	MIC
2	Line Out

4.2.10 Optional I/O

ARK-2121V-S6A1E provides two optional DB9 connectors which can have possible combination as below.

- 2 x DB9 connectors for RS-232/422/485 signal (Default)
- CANBus 2.0A/B (Module option)

DB9_1	DB9_2
COM	COM
1 x CANBus	1 x CANBus
COM	2 x CANBus
2 x CANBus	COM

4.2.11 Power Input Mode

ARK-2121V provides two power input mode. One is P and the other one is V. P means for power adapter; V means for in-vehicle purpose.



Figure 4.10 Power Input Mode

4.2.12 Power On/Off Button

ARK-2121V comes with a Power On/Off button, that support dual function of Soft Power -On/Off (Instant off or Delay 4 Second), and Suspend.

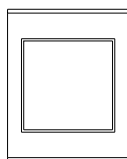

Figure 4.11 Power ON/OFF Button

4.2.13 Reset

ARK-2121V comes with reset function for users to reset the unit if necessary.



Figure 4.12 Reset

4.2.14 LED Indicator

There are two LEDs on ARK-2121V front metal face plate for indicating system status: PWR LED is for power status; and SSD LED is for SSD flash disk status.



Figure 4.13 LED Indicator

4.3 ARK-2121V-S9A1E I/O Connectors

4.3.1 ARK-2121V-S9A1E Front I/O View

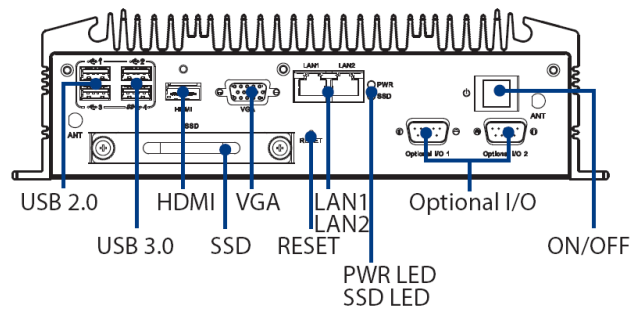

4.3.2 ARK-2121V-S9A1E Rear I/O View

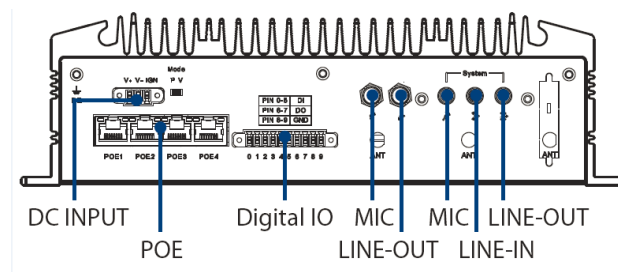

4.4 ARK-2121V-S9A1E I/O Pin Definition

4.4.1 VGA Connector

The ARK-2121V provides a high resolution VGA interface connected by a D-sub 15-pin connector to support a VGA CRT monitor. It supports display resolution of up to 1920 x 1200 with 60 Hz.

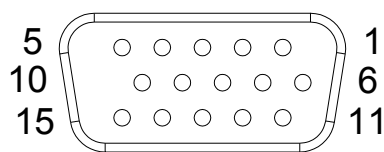

Figure 4.14 VGA Connector

Table 4.8: VGA Connector Pin Assignments

Pin	Signal Name	Pin	Signal Name
1	Red	2	Green
3	Blue	4	NC
5	GND	6	GND
7	GND	8	GND
9	NC	10	GND
11	NC	12	DDC Date
13	H-SYNC	14	V-SYNC
15	DDC Clock		

4.4.2 USB Connector

The ARK-2121V provides up to four USB interface connectors - 3 x USB 2.0 & 1 x USB 3.0, which give complete Plug & Play. The USB interface is compliant with USB UHCI, Rev. 2.0 & 3.0. The USB interface supports Plug and Play, which enables you to connect or disconnect a device whenever you want, without turning off the computer.

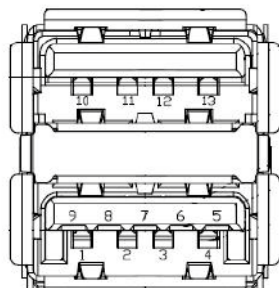

Figure 4.15 USB Connector [Upper (black): USB2.0 / Down (blue): USB 3.0]

Table 4.9: USB Connector Pin Assignments

Pin	Signal Name	Pin	Signal Name
1	+5V	2	D-
3	D+	4	GND
5	SSRX-	6	SSRX+
7	GND	8	SSTX-
9	SSTX+	10	+5V
11	D-	12	D+
13	GND		

4.4.3 Ethernet Connector

ARK-2121V provides two RJ45 LAN interface connectors, which are fully compliant with IEEE 802.3u 10/100/1000 Base-T CSMA/CD standards. LAN1 is equipped with Intel I218 GbE and LAN2 is equipped with Intel I210 GbE. The Ethernet ports use standard RJ-45 jack connectors with LED indicators on the front side to show Active/Link status and Speed status.

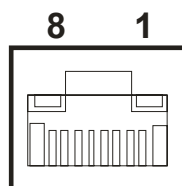

Figure 4.16 Ethernet Connector

Table 4.10: Ethernet Connector Pin Assignments

Pin	Signal Name	Pin	Signal Name
1	TX+(10/100),BI_DA+(GHz)	5	BI_DC-(GHz)
2	TX-(10/100),BI_DA-(GHz)	6	RX-(10/100),BI_DB-(GHz)
3	RX+(10/100),BI_DB+(GHz)	7	BI_DD+(GHz)
4	BI_DC+(GHz)	8	BI_DD-(GHz)

4.4.4 HDMI Connector

ARK-2121V provides 1 x lockable HDMI port which resolution can support up to 1080P.

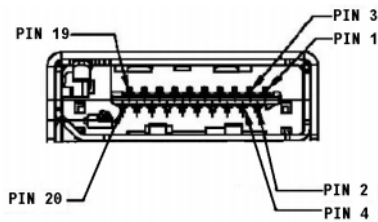

Figure 4.17 HDMI Connector

Table 4.11: HDMI / Display Port Connector Pin Assignments

Pin	Signal Name	Pin	Signal Name
1	TMDS_Data2+/ DP_Data0+	2	GND
3	TMDS_Data2-/ DP_Data0-	4	TMDS_Data1+/ DP_Data1+
5	GND	6	TMDS_Data1-/ DP_Data1-
7	TMDS_Data0+/ DP_Data2+	8	GND
9	TMDS_Data0-/ DP_Data2-	10	TMDS_Clock+/ DP_Data3+
11	GND	12	TMDS_Clock-/ DP_Data3-
13	NC	14	NC
15	SCL/ AUX_CH+	16	SDA/ GND
17	DDC GND/ AUX_CH-	18	+5V/ Hot plug detect
19	Hot plug detect/ Return	20	DP_PWR

4.4.5 DIO Connector

ARK-2121V offers an 8-bit phenix type DIO connector and two ground pin. 6 x DI & 2 x DO w/ 3 KV isolation.

- **Connector Type:** 10-pin screw terminal block (6 DI points, 2 DO points, GND)
- **Input Voltage:** 0 to 30 VDC at 25 Hz
- **Digital Input Levels for Dry Contacts:**
Logic level 0: Close to GND
Logic level 1: Open
- **Digital Input Levels for Wet Contacts:**
Logic level 0: +3 V max
Logic level 1: +5 V to +30 V
- **Output Current:** Max. 500 mA per channel
- **On-state Voltage:** 24 VDC nominal, open collector to 30 VDC

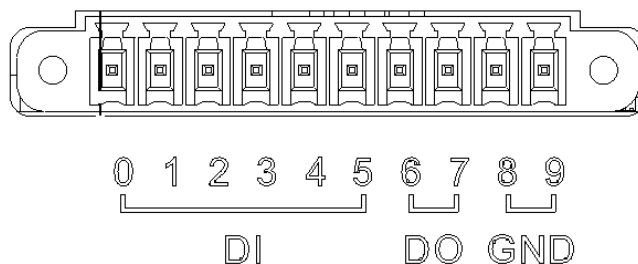

Figure 4.18 DIO Connector

4.4.6 Power Input Connector

ARK-2121V comes with 3-pin phenix type power input connector for 9 ~ 36 VDC input.

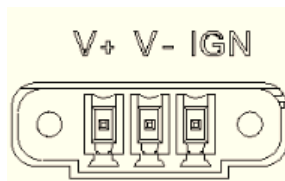

Figure 4.19 Power Input Connector

4.4.7 Power Over Ethernet

ARK-2121V-S9A1E provides 4 x 10/100 PoE ports.

- 4ports full-load, IEEE802.3af Class 2 (7 Watt)
- 2ports full-load, IEEE802.3af Class 3 (15.4 Watt)

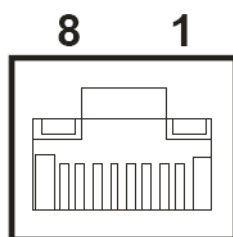

Figure 4.20 Power Over Ethernet Connector

Table 4.12: Power Over Ethernet (PoE) Pin Definition

Pin	Signal Name	Pin	Signal Name
1	Rx + / DC +	5	unused
2	RX - / DC +	6	Tx - / DC -
3	Tx + / DC -	7	Unused
4	Unused	8	Unused

4.4.8 System Audio Connector

ARK-2121V offers stereo audio ports by a phone jack connector of Line-out, Mic-in & Line-in. The audio chip controller is by Realtek ALC888, High Definition Audio.

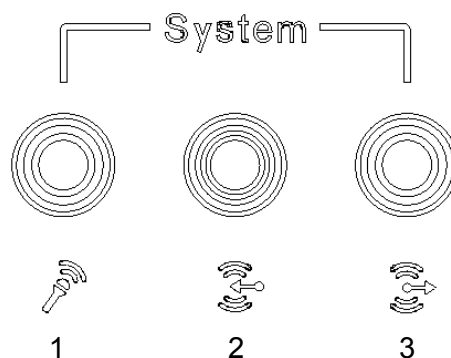

Figure 4.21 System Audio Connector

Table 4.13: Audio Connector Pin Assignments

Pin	Audio Signal Name
1	MIC
2	Line-In
3	Line-Out

4.4.9 Cellular Voice Connector

ARK-2121V offers stereo audio ports by a phone jack connector of Line-out & Mic-in.

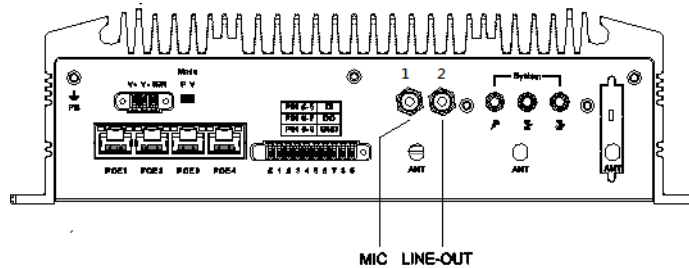

Figure 4.22 Cellular Voice Connector

Table 4.14: Cellular Voice Connector Pin Assignments

Pin	Cellular Signal Name
1	MIC
2	Line Out

4.4.10 Optional I/O

ARK-2121V-S9A1E provides two optional DB9 connectors which can have possible combination as below.

- 2 x DB9 connectors for RS-232/422/485 signal (Default)
- CANBus 2.0A/B (Module option)

DB9_1	DB9_2
COM	COM
1 x CANBus	1 x CANBus
COM	2 x CANBus
2 x CANBus	COM

4.4.11 Power Input Mode

ARK-2121V provides two power input mode. One is P and the other one is V. P means for power adapter; V means for in-vehicle purpose.

Mode

P V



Figure 4.23 Power Input Mode

4.4.12 Power On/Off Button

ARK-2121V comes with a Power On/Off button, that support dual function of Soft Power -On/Off (Instant off or Delay 4 Second), and Suspend.

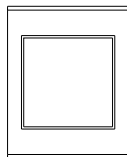

Figure 4.24 Power ON/OFF Button

4.4.13 Reset

ARK-2121V comes with reset function for users to reset the unit if necessary.



Figure 4.25 Reset

4.4.14 LED Indicator

There are two LEDs on ARK-2121V front metal face plate for indicating system status: PWR LED is for power status; and SSD LED is for SSD flash disk status.



Figure 4.26 LED Indicator

Chapter 5

BIOS settings

This chapter introduces how to set BIOS configuration data.

5.1 Introduction

AMIBIOS has been integrated into many motherboards for over a decade. With the AMIBIOS Setup program, you can modify BIOS settings and control the various system features. This chapter describes the basic navigation of the ARK-2121V BIOS setup screens.

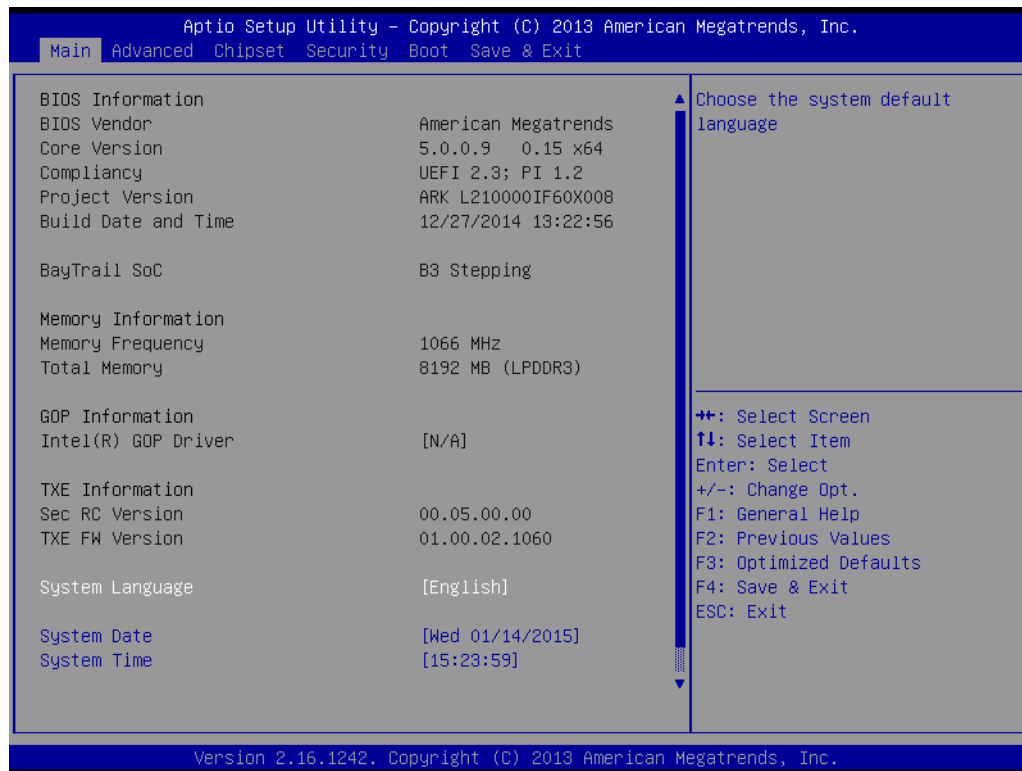

Figure 5.1 Setup program initial screen

AMI's BIOS ROM has a built-in setup program that allows users to modify the basic system configuration. This information is stored in battery-backed CMOS so it retains the setup information when the power is turned off.

5.2 Entering Setup

Turn on the computer and then press <F2> or to enter the Setup menu.

5.2.1 Main Setup

When you first enter the BIOS Setup Utility, you will enter the Main setup screen. You can always return to the Main setup screen by selecting the Main tab. There are two Main Setup options. They are described in this section. The Main BIOS Setup screen is shown below.



Figure 5.2 Main setup screen

The Main BIOS setup screen has two main frames. The left frame displays all the options that can be configured. Grayed-out options cannot be configured; options in blue can. The right frame displays the key legend.

Above the key legend is an area reserved for a text message. When an option is selected in the left frame, it is highlighted in white. Often a text message will accompany it.

■ System Time / System Date

Use this option to change the system time and date. Highlight System Time or System Date using the <Arrow> keys. Enter new values through the keyboard. Press the <Tab> key or the <Arrow> keys to move between fields. The date must be entered in MM/DD/YY format. The time must be entered in HH:MM:SS format.

5.2.2 Advanced BIOS Features Setup

Select the Advanced tab from the ARK-2121V setup screen to enter the Advanced BIOS Setup screen. You can select any of the items in the left frame of the screen, such as CPU Configuration, to go to the sub menu for that item. You can display an Advanced BIOS Setup option by highlighting it using the <Arrow> keys. All Advanced BIOS Setup options are described in this section. The Advanced BIOS Setup screens are shown below. The sub menus are described on the following pages.

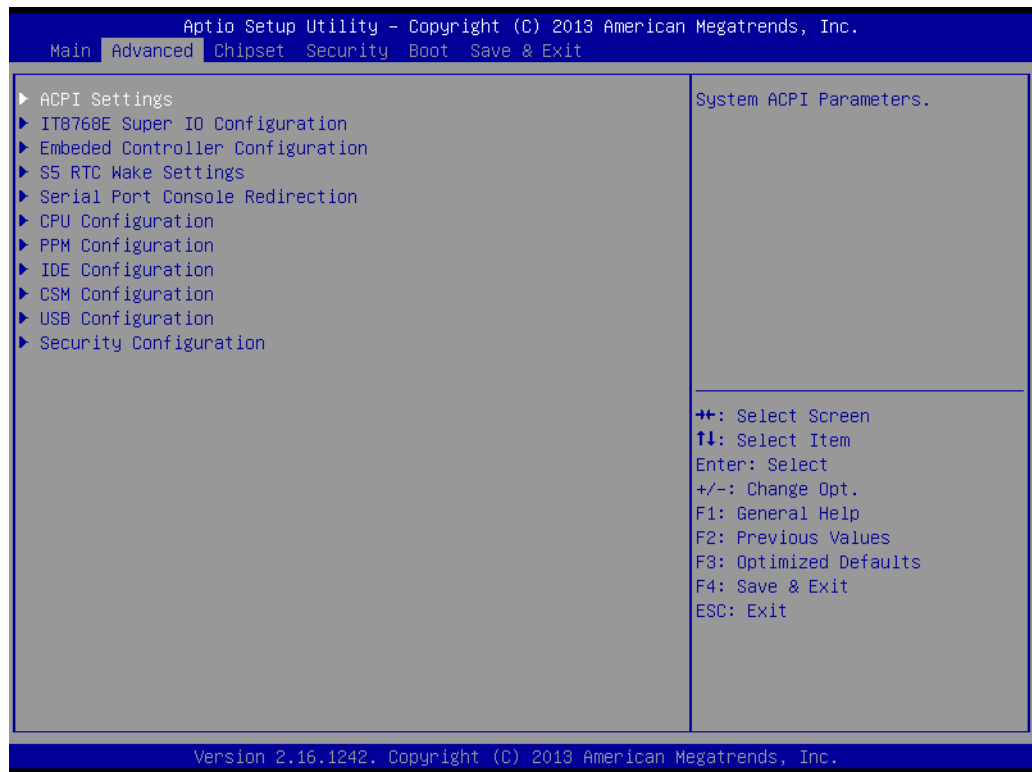
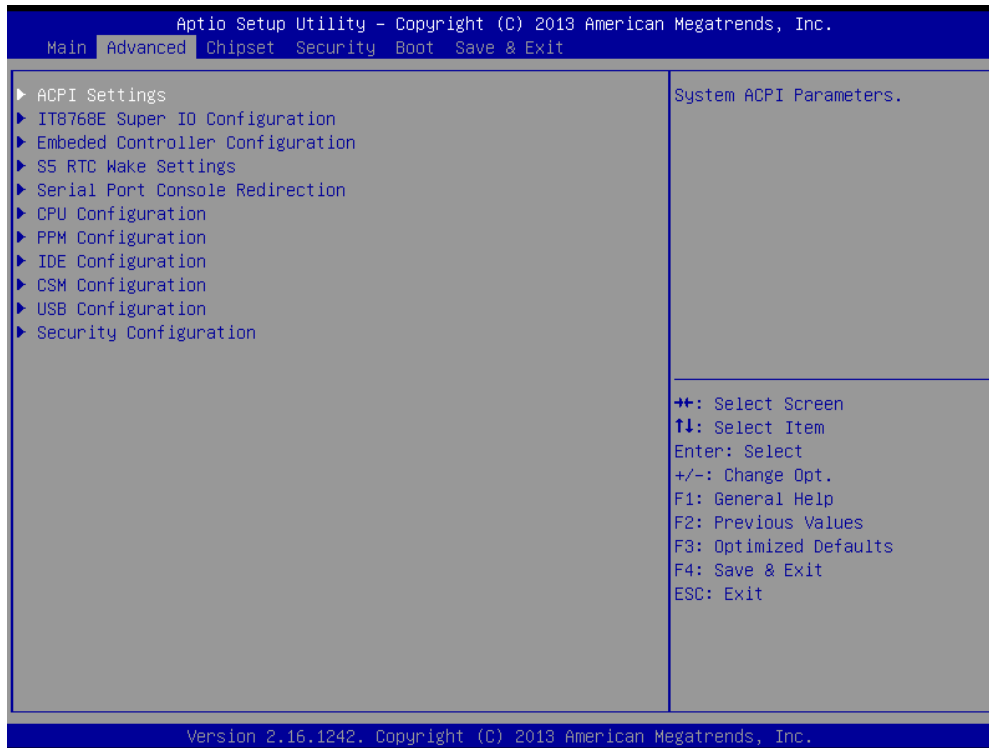

Figure 5.3 Advanced BIOS features setup screen

5.2.2.1 ACPI Setting



- **Enable ACPI Auto Configuration**
Enable or Disable BIOS ACPI auto configuration
- **Enable Hibernation**
Enables or Disables system ability to hibernate (OS/S4 Sleep State). This option may not be effective with some OS.
- **ACPI Sleep State**
Select the highest ACPI sleep state the system will enter when the SUSPEND button is pressed
- **Lock Legacy Resources**
Enables or disables lock of legacy resources

5.2.2.2 Super I/O Configuration

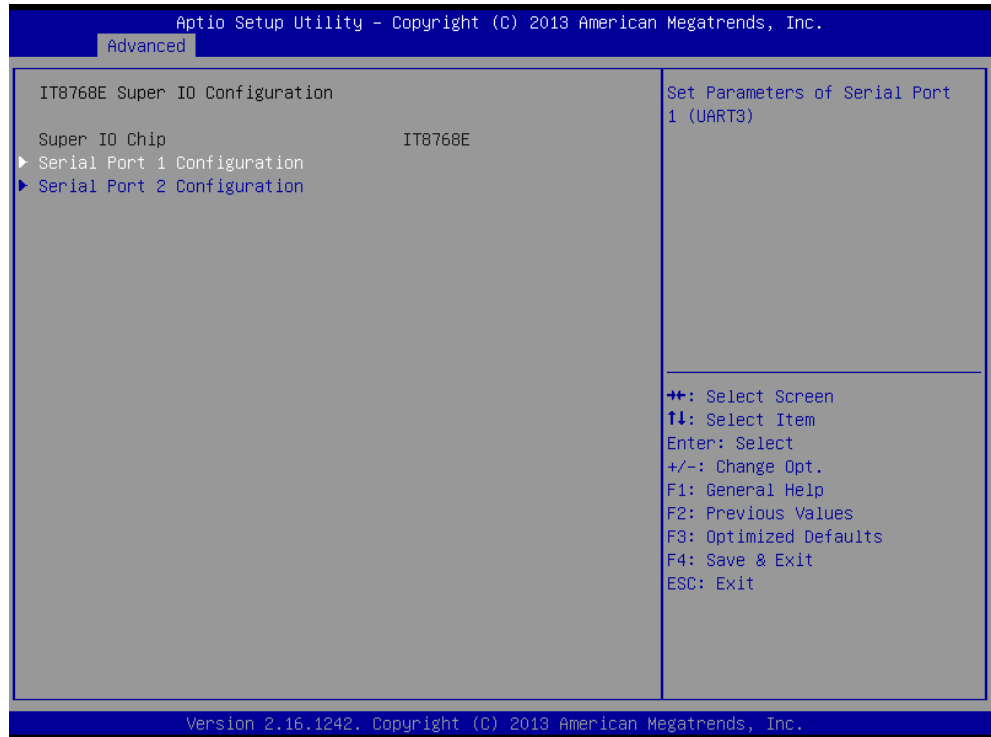



- **Serial Port 1 Configuration**
This item allows users to configure serial port 1.
- **Serial Port 2 Configuration**
This item allows users to configure serial port 1.
- **Serial Port 3 Configuration**
This item allows users to configure serial port 1.
- **Serial Port 4 Configuration**
This item allows users to configure serial port 1.

5.2.2.3 Embedded Controller Configuration

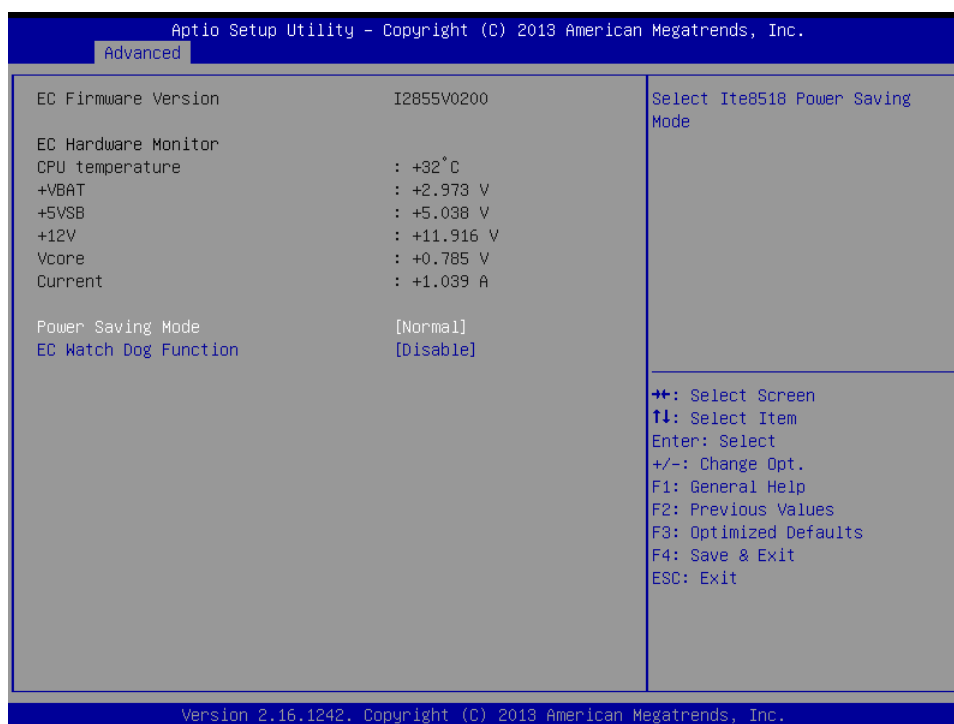

- **EC Hardware Monitor**
This page display all information about system Temperature/Voltage/Current.
- **iManager WatchDog IRQ**
This item allows users to set the IRQ number of EC watchdog.
- **Backlight Enable Polarity**
This item allows users to set backlight mode.
- **EC Power Saving Mode**
This item allows users to set board's power saving mode when off.
- **EC Watch Dog Function**
This item allows users to select EC watchdog timer.

5.2.2.4 S5 RTC Wake Settings



- **Wake system from S5**
Enable or disable System wake on alarm event. Select FixedTime, system will wake on the hr::min::sec specified.

5.2.2.5 Serial Port Console Redirection

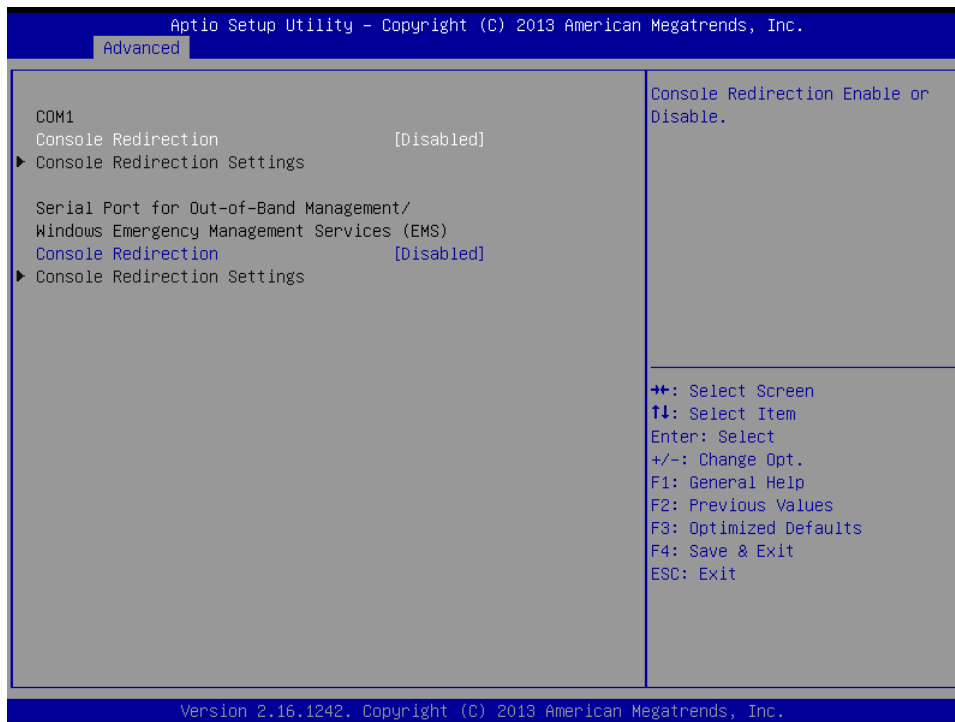

- **Console Redirection**
This item allows users to enable or disable console redirection for Microsoft-Windows Emergency Management Services (EMS).
- **Console Redirection**
This item allows users to configuration console redirection detail settings.

5.2.2.6 CPU Configuration

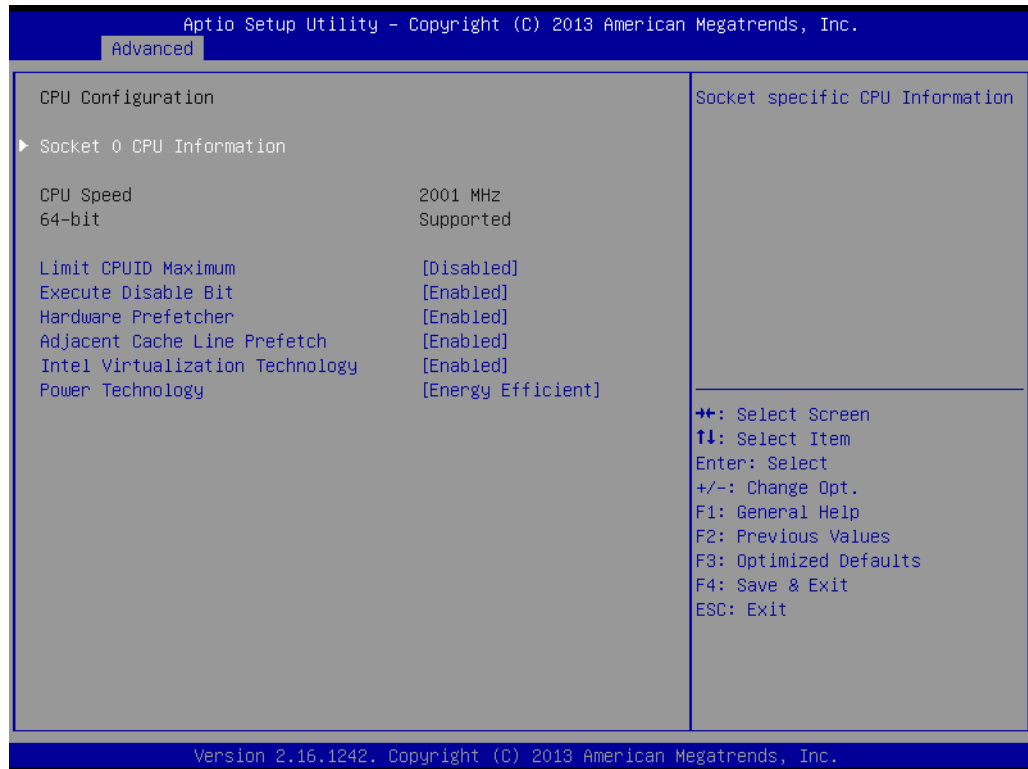

- **Limit CPUID Maximum**
Disabled for Windows XP.
- **Execute Disable Bit**
XD can prevent certain classes of malicious buffer overflow attacks when combined with a supporting OS (Windows Server 2003 SP1, Windows XP SP2, SuSE Linux 9.2, RedHat Enterprise 3 Update 3.)
- **Hardware Prefetcher**
Enable the mid level cache(L2) streamer prefetcher.
- **Adjacent Cache Line Prefetch**
Enable the mid level cache(L2) prefetching of adjacent cache lines.
- **Intel Virtualization Technology**
When enabled, a VMM can utilize the additional hardware capabilities provided by Vanderpool Technology.
- **Power Technology**
Enable the power management features.

5.2.2.7 PPM Configuration



- **CPU C state Report**
Enable/Disable CPU C state report to OS.
- **Max CPU C-state**
This option controls Max C state that the processor will support.
- **S0ix**
Enable/Disable CPU S0ix state.

5.2.2.8 IDE Configuration

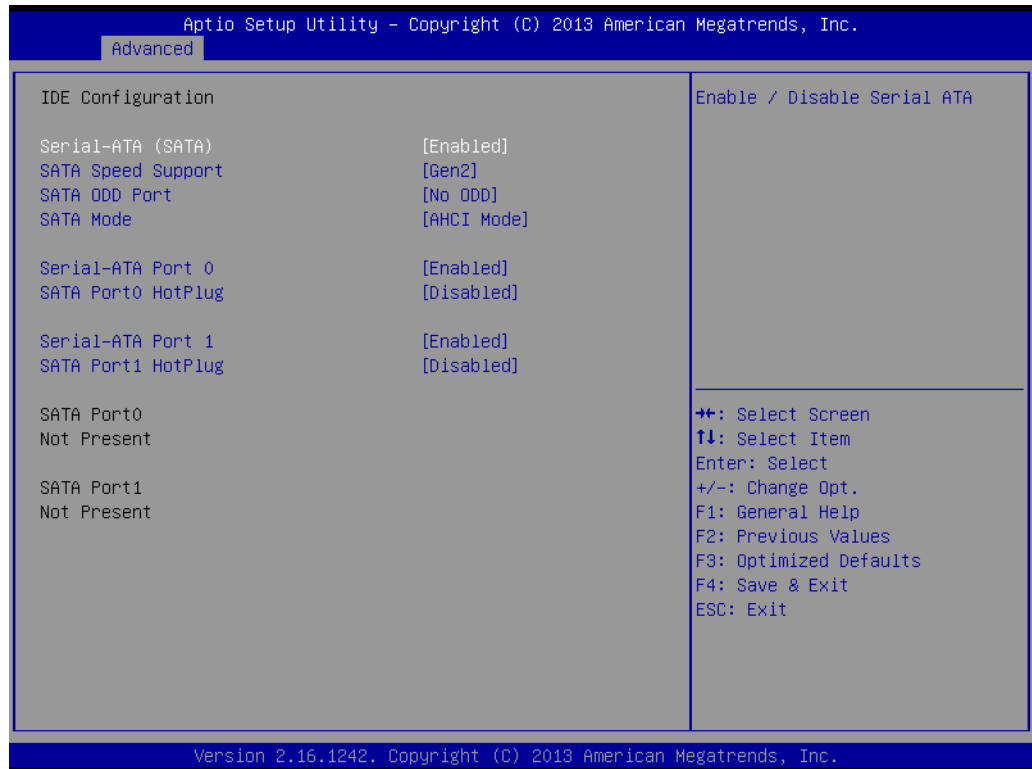

- **Serial-ATA (SATA)**
Enable / Disable Serial ATA.
- **SATA Speed Support**
SATA Speed Support Gen1 or Gen2.
- **SATA ODD Port**
SATA ODD is Port0 or Port1.
- **SATA Mode**
Select IDE / AHCI.
- **Serial-ATA Port 0 / Port1**
Enable / Disable Serial ATA Port0 / Port1.
- **SATA Port 0 / Port1 HotPlug**
Enable / Disable SATA Port0 / Port1 hotplug function.

5.2.2.9 CSM Configuration

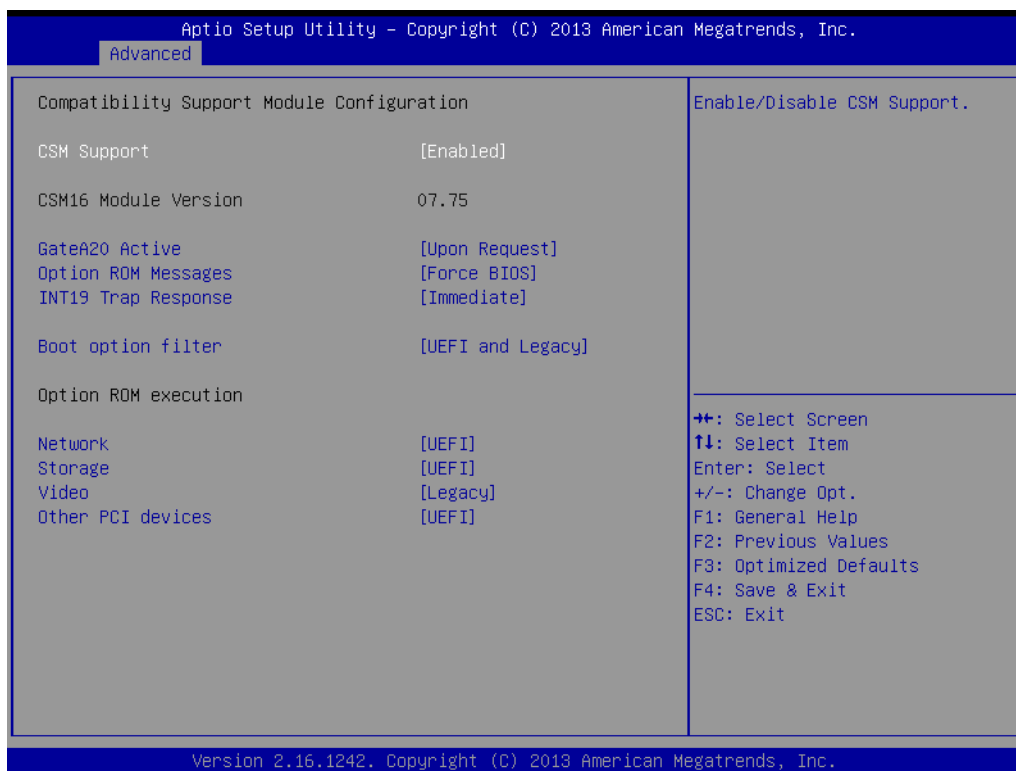

- **CSM Support**
Enable/Disable CSM Support.
- **GateA20 Active**
UPON REQUEST - GA20 can be disabled using BIOS services. ALWAYS - do not allow disabling GA20; this option is useful when any RT code is executed above 1MB.
- **Option ROM Messages**
Set display mode for Option ROM.
- **INT19 Trap Response**
BIOS reaction on INT19 trapping by Option ROM: IMMEDIATE - execute the trap right away; POSTPONED - execute the trap during legacy boot.
- **Boot option filter**
This option controls Legacy/UEFI ROMs priority.
- **Network**
Controls the execution of UEFI and Legacy PXE OpROM.
- **Storage**
Controls the execution of UEFI and Legacy Storage OpROM.
- **Video**
Controls the execution of UEFI and Legacy Video OpROM.
- **Other PCI devices**
Determines OpROM execution policy for devices other than Network, Storage, or Video.

5.2.2.10 USB Configuration

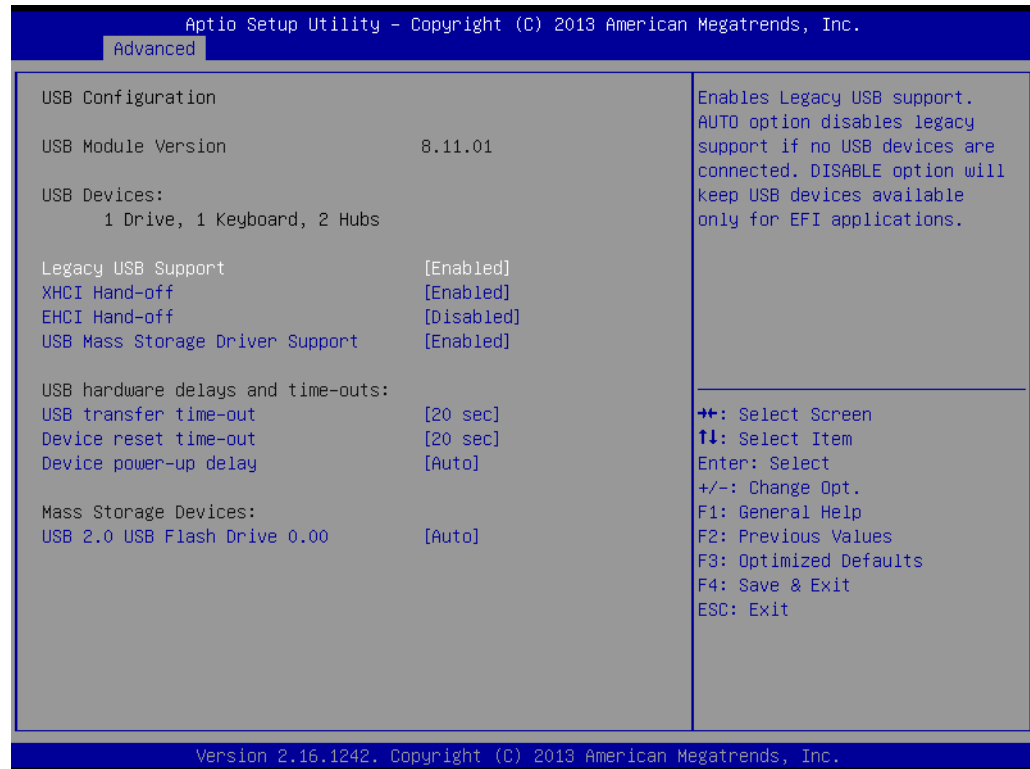

- **Legacy USB Support**
Enables Legacy USB support. AUTO option disables legacy support if no USB devices are connected. DISABLE option will keep USB devices available only for EFI applications.
- **XHCI Hand-off**
This is a workaround for OSES without XHCI hand-off support. The XHCI ownership change should be claimed by XHCI driver.
- **EHCI Hand-Off**
This is a workaround for OSES without EHCI hand-off support. The EHCI ownership change should claim by EHCI driver.
- **USB Mass Storage Driver Support**
Enable/Disable USB Mass Storage Driver Support.
- **USB transfer time-out**
Time-out value for control, Bulk, and interrupt transfers.
- **Device reset time-out**
USB mass storage device start unit command time-out.
- **Device power-up delay**
Maximum time the device will take before it properly reports itself to the Host Controller. 'Auto' uses default value: for a Root port it is 100 ms, for a Hub port the delay is taken from Hub descriptor.

5.2.2.11 Security Configuration



- **TXE**
- **TXE HMRFPD Disable**
- **TXE Firmware Update**
- **TXE EOP Message**
Send EOP Message Befor Enter OS
- **TXE Unconfiguration Perform**
Revert TXE settings to factory defaults

5.2.3 Chipset Configuration

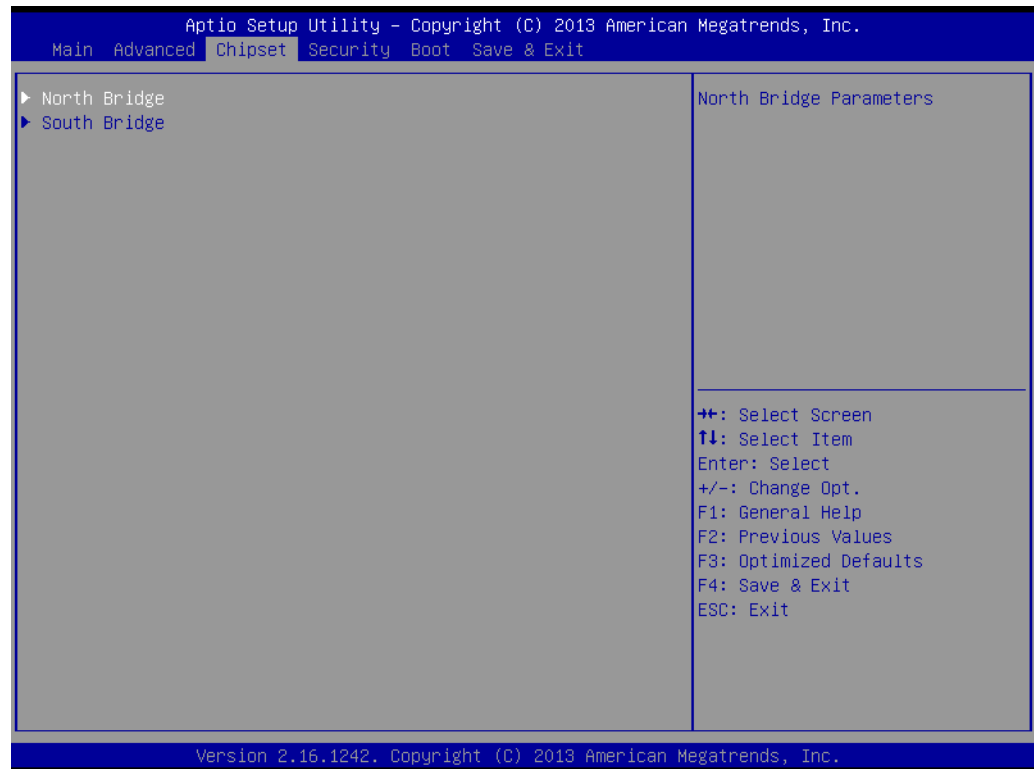

- **North Bridge**
Detail for North Bridge items.
- **South Bridge**
Detail for South Bridge items.

5.2.3.1 Intel IGD Configuration

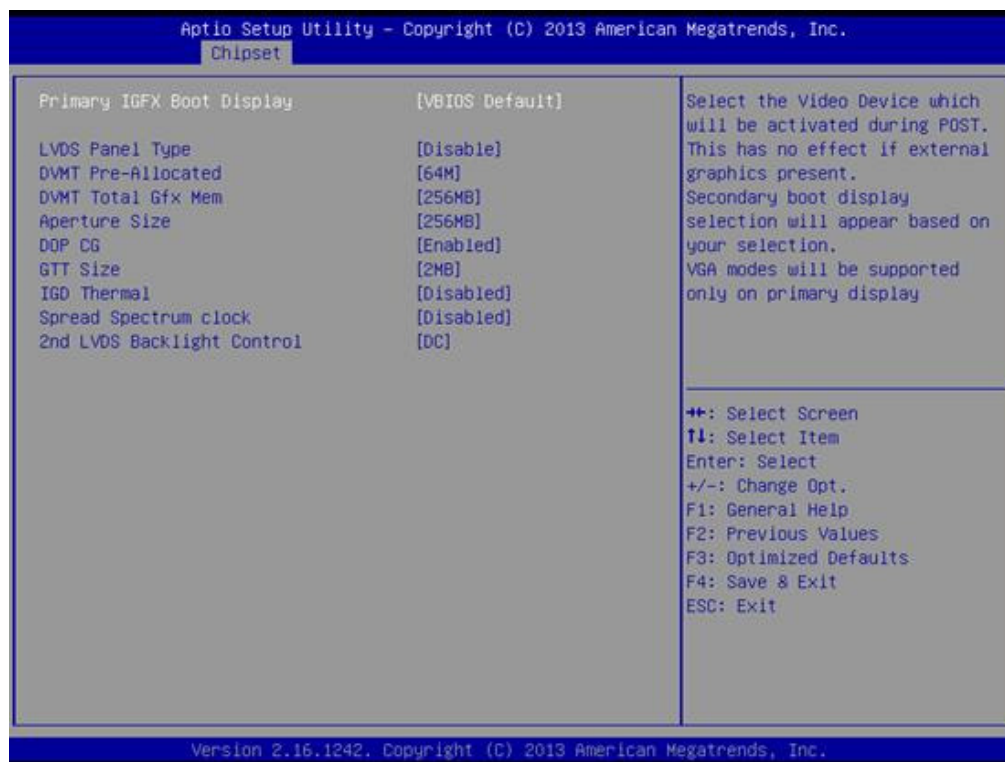

- **Primary IGFX Boot Display**
Select the Video Device which will be activated during POST.
This has no effect if external graphics present.
Secondary boot display selection will appear based on your selection.
VGA modes will be supported only on primary display.
- **LVDS Panel Type**
This item allow user to select LVDS panel type.
- **DVMT Pre-Allocated**
Select DVMT 5.0 Pre-Allocated (Fixed) Graphics Memory size used by the Internal Graphics Device.
- **DVMT Total Gfx Mem**
Select DVMT 5.0 Total Graphic Memory size used by the Internal Graphics Device.
- **Aperture Size**
Select the Aperture Size.
- **DOP CG**
Enable/Disable DOP clock gating.
- **GTT Size**
Select the GTT Size
- **IGD Thermal**
Enable/Disable IGD Thermal.
- **Spread Spectrum clock**
Enable/Disable Spread Spectrum clock.

5.2.3.2 South Bridge

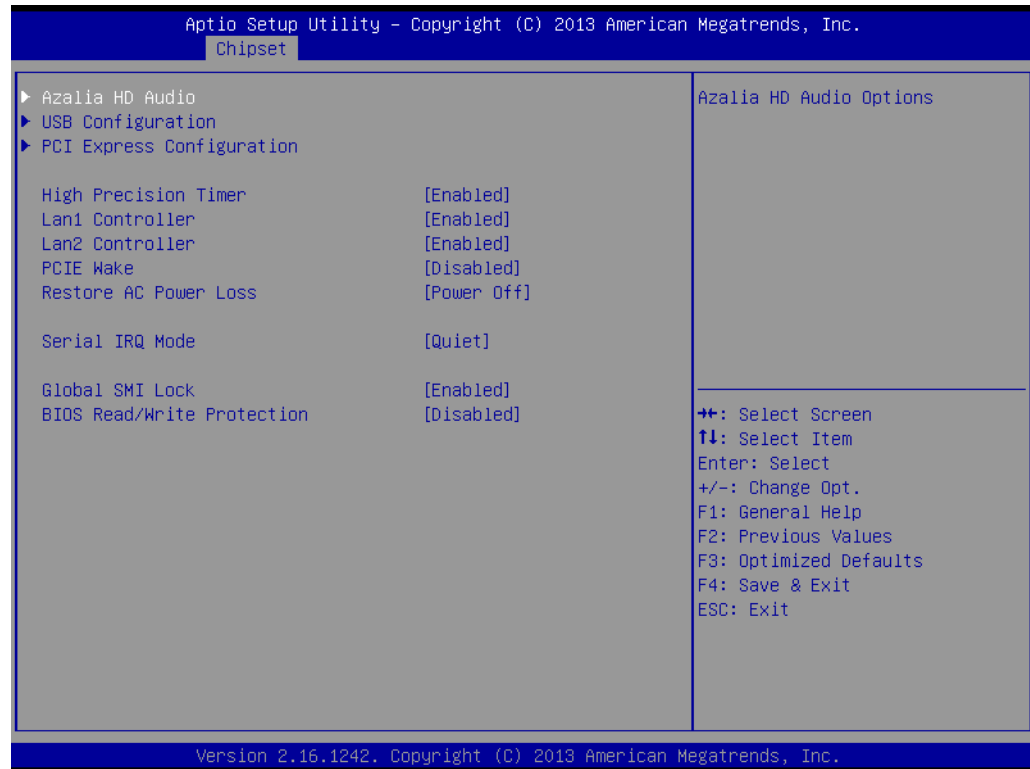

- **Azalia HD Audio**
Azalia HD Audio Options.
- **USB Configuration**
USB Configuration Settings.
- **PCI Express Configuration**
PCI Express Configuration settings.
- **High Precision Timer**
Enables or disables the high precision timer.
- **LAN1 Controller**
Enable or Disable the LAN1.
- **LAN2 Controller**
Enable or Disable the LAN2.
- **PCIE Wake**
Enable or Disable PCIE to wake the system from S5.
- **Restore AC Power Loss**
Select AC power state when power is re-applied after a power failure.
- **Serial IRQ Mode**
Configure Serial IRQ Mode.
- **Global SMI Lock**
Enable or Disable SMI lock.
- **BIOS Read/Write Protection**
Enable or Disable BIOS SPI region read/write protect.

5.2.3.3 Azalia HD Audio

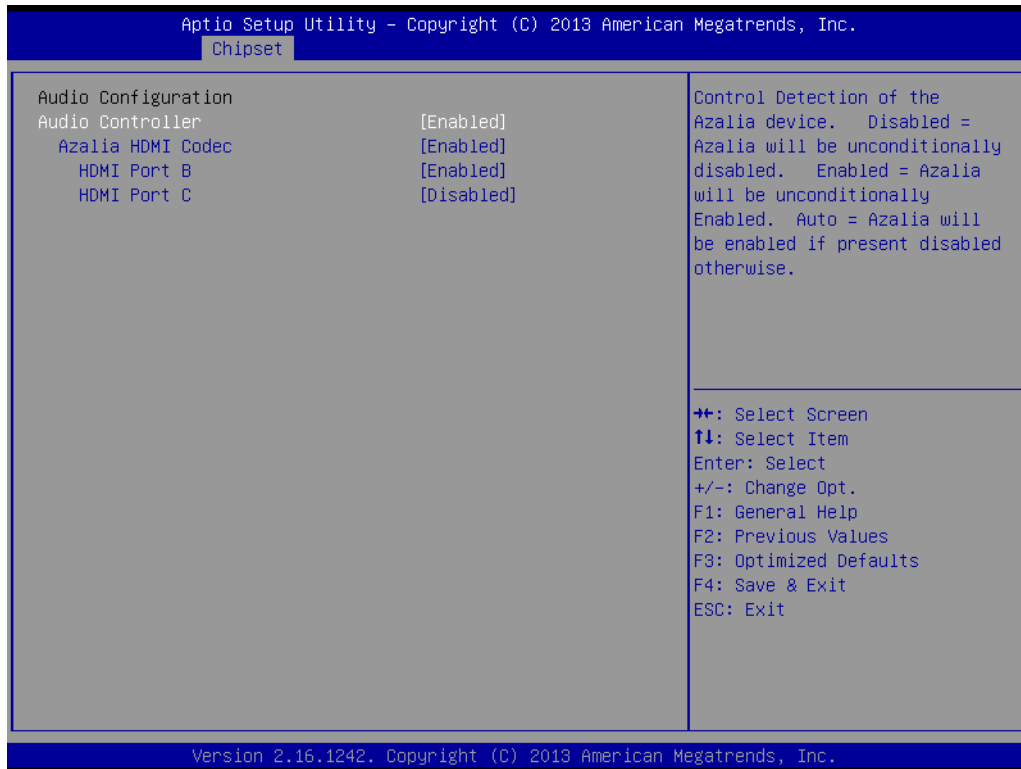

- **Audio Controller**
Control Detection of the Azalia device. Disabled = Azalia will be unconditionally disabled. Enabled = Azalia will be unconditionally Enabled. Auto = Azalia will be enabled if present disabled otherwise.
- **Azalia HDMI Codec**
Enable/Disable internal HDMI codec for Azalia
- **HDMI Port B**
Enable/Disable HDMI Port B
- **HDMI Port C**
Enable/Disable HDMI Port C

5.2.3.4 USB Configuration

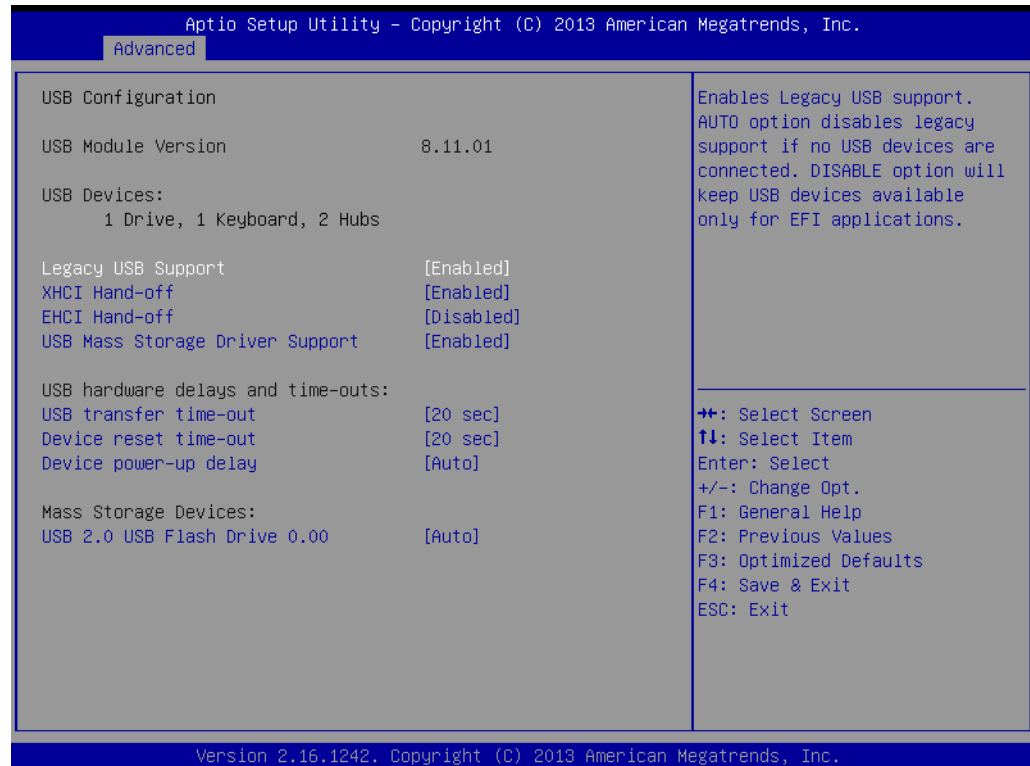

- **Legacy USB Support**
Enables Legacy USB support. AUTO option disables legacy support if no USB devices are connected. DISABLE option will keep USB devices available only for EFI applications.
- **XHCI Hand-off**
This is a workaround for OSES without XHCI hand-off support. The XHCI ownership change should be claimed by XHCI driver.
- **EHCI Hand-Off**
This is a workaround for OSES without EHCI hand-off support. The EHCI ownership change should claim by EHCI driver.
- **USB Mass Storage Driver Support**
Enable/Disable USB Mass Storage Driver Support.
- **USB transfer time-out**
Time-out value for control, Bulk, and interrupt transfers.
- **Device reset time-out**
USB mass storage device start unit command time-out.
- **Device power-up delay**
Maximum time the device will take before it properly reports itself to the Host Controller. 'Auto' uses default value: for a Root port it is 100 ms, for a Hub port the delay is taken from Hub descriptor.

5.2.3.5 PCI Express Configuration



- **PCI Express Port0 / Port2**
Enable or Disable the PCI Express Port0 / Port 2 in the Chipset.
- **Speed**
Configure PCIe Port Speed.

5.2.4 Security

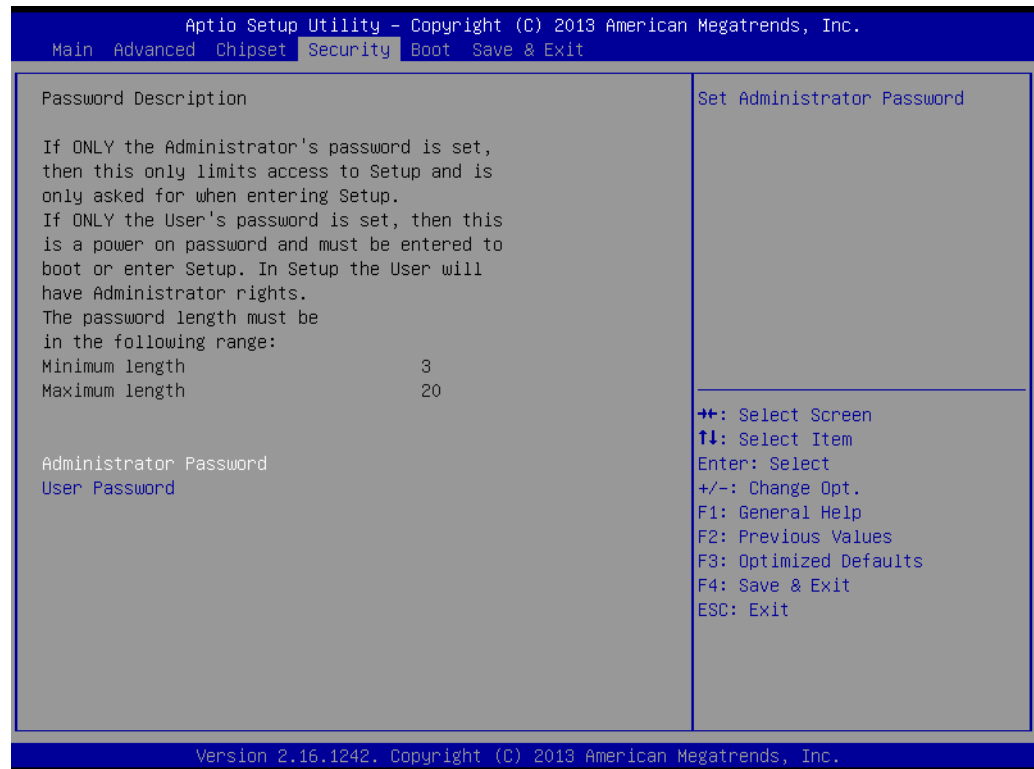

Select Security Setup from the MIO-5251 Setup main BIOS setup menu. All Security Setup options, such as password protection and virus protection are described in this section. To access the sub menu for the following items, select the item and press <Enter>:

- **Change Administrator / User Password**

Select this option and press <ENTER> to access the sub menu, and then type in the password.

5.2.5 Boot



- **Setup Prompt Timeout**
Number of seconds that the firmware will wait before initiating the original default boot selection. A value of 0 indicates that the default boot selection is to be initiated immediately on boot. A value of 65535(0xFFFF) indicates that firmware will wait for user input before booting. This means the default boot selection is not automatically started by the firmware.
- **Bootup NumLock State**
Select the keyboard NumLock state.
- **Quiet Boot**
Enables or disables Quiet Boot option.
- **Boot Option #1**
Sets the system boot order.

5.2.6 Save & Exit

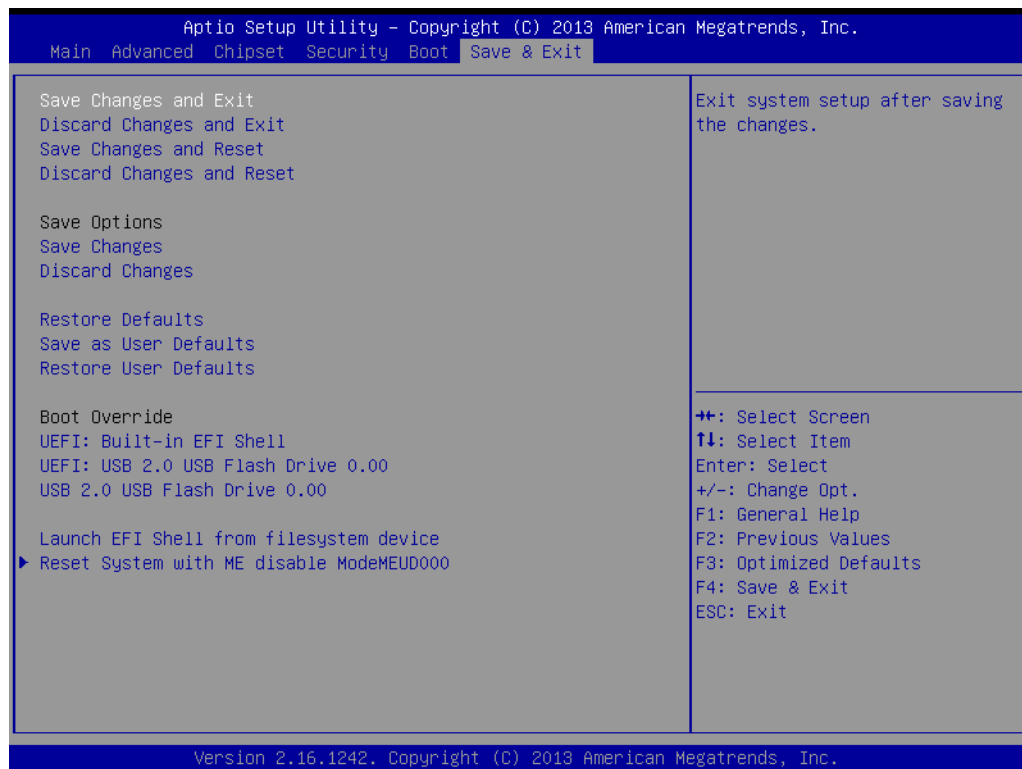

- **Save Changes and Exit**
This item allows you to exit system setup after saving the changes.
- **Discard Changes and Exit**
This item allows you to exit system setup without saving any changes.
- **Save Changes and Reset**
This item allows you to reset the system after saving the changes.
- **Discard Changes and Reset**
This item allows you to rest system setup without saving any changes.
- **Save Changes**
This item allows you to save changes done so far to any of the options.
- **Discard Changes**
This item allows you to disccard changes done so far to any of the options.
- **Restore Defaults**
This item allows you to restore/load default values for all the options.
- **Save as User Defaults**
This item allows you to save the changes done so far as user defaults.
- **Restore User Defaults**
This item allows you to restore the user defaults to all the options.
- **Boot Override**
Boot device select can override your boot priority.

Appendix **A**

WDT Sample Code

A.1 Watchdog Timer Sample Code

```
EC_Command_Port = 0x29Ah
EC_Data_Port = 0x299h
Write EC HW ram = 0x89
Watch dog event flag = 0x57
Watchdog reset delay time = 0x5E
Reset event = 0x04
Start WDT function = 0x28
=====
.model small
.486p
.stack 256
.data
.code
org 100h
.STARTup

mov dx, EC_Command_Port
mov al,89h ; Write EC HW ram.
out dx,al

mov dx, EC_Data_Port
mov al, 5Fh ; Watchdog reset delay time low byte (5Eh is high
byte) index.
out dx,al

mov dx, EC_Data_Port
mov al, 30h ;Set 3 seconds delay time.
out dx,al

mov dx, EC_Command_Port
mov al,89h ; Write EC HW ram.
out dx,al

mov dx, EC_ EC_Data_Port
mov al, 57h ; Watch dog event flag.
out dx,al

mov dx, EC_Data_Port
mov al, 04h ; Reset event.
out dx,al

mov dx, EC_Command_Port
mov al,28h ; start WDT function.
out dx,al
.exit
```

ADVANTECH

Enabling an Intelligent Planet

www.advantech.com

Please verify specifications before quoting. This guide is intended for reference purposes only.

All product specifications are subject to change without notice.

No part of this publication may be reproduced in any form or by any means, electronic, photocopying, recording or otherwise, without prior written permission of the publisher.

All brand and product names are trademarks or registered trademarks of their respective companies.

© Advantech Co., Ltd. 2015