

CGH40006S

6 W, RF Power GaN HEMT, Plastic

Description

WolfSpeed's CGH40006S is an unmatched, gallium nitride (GaN) high electron mobility transistor (HEMT). The CGH40006S, operating from a 28 volt rail, offers a general purpose, broadband solution to a variety of RF and microwave applications. GaN HEMTs offer high efficiency, high gain and wide bandwidth capabilities making the CGH40006S ideal for linear and compressed amplifier circuits. The transistor is available in a 3mm x 3mm, surface mount, quad-flat-no-lead (QFN) package.

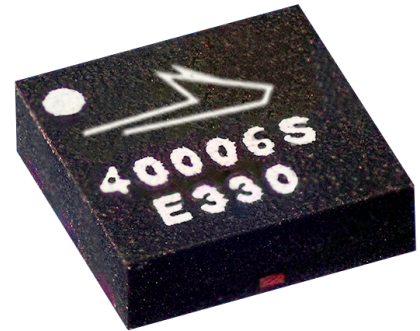

Package Type: 440203
PN: CGH40006S

Features

- Up to 6 GHz Operation
- 13 dB Small Signal Gain at 2.0 GHz
- 11 dB Small Signal Gain at 6.0 GHz
- 8 W typical at $P_{IN} = 32$ dBm
- 65% Efficiency at $P_{IN} = 32$ dBm
- 28 V Operation
- 3mm x 3mm Package

Applications

- 2-Way Private Radio
- Broadband Amplifiers
- Cellular Infrastructure
- Test Instrumentation
- Class A, AB, Linear amplifiers suitable for OFDM, W-CDMA, EDGE, CDMA waveforms



Large Signal Models Available for ADS and MWO



Absolute Maximum Ratings (not simultaneous) at 25°C Case Temperature

Parameter	Symbol	Rating	Units	Conditions
Drain-Source Voltage	V_{DSS}	120	V	25°C
Gate-to-Source Voltage	V_{GS}	-10, +2		
Storage Temperature	T_{STG}	-65, +150	°C	
Operating Junction Temperature	T_J	175		
Maximum Forward Gate Current	I_{GMAX}	2.1	mA	25°C
Maximum Drain Current ¹	I_{DMAX}	0.75		
Soldering Temperature ²	T_S	260	°C	
Thermal Resistance, Junction to Case ^{3,4}	$R_{\theta JC}$	10.1	°C/W	
Case Operating Temperature ^{3,4}	T_C	-40, +150	°C	85°C

Notes:

¹ Current limit for long term, reliable operation

² Refer to the Application Note on soldering at wolfspeed.com/rf/document-library

³ Measured for the CGH40006S at $P_{DISS} = 8$ W.

⁴ T_C = Wolfspeed temperature for the device. It refers to the temperature at the ground tab underneath the package. The PCB will add additional thermal resistance. The RTH for Wolfspeed's demonstration amplifier, CGH40006S-AMP1, with 13 (Ø20 mil) via holes designed on a 20 mil thick Rogers 5880 PCB, is 5.1°C. The total Rth from the heat sink to the junction is 10.1°C + 5.1°C = 15.2°C/W.

Electrical Characteristics ($T_C = 25^\circ\text{C}$)

Characteristics	Symbol	Min.	Typ.	Max.	Units	Conditions
DC Characteristics¹						
Gate Threshold Voltage	$V_{GS(th)}$	-3.8	-3.0	-2.3	V_{DC}	$V_{DS} = 10$ V, $I_D = 132.8$ mA
Gate Quiescent Voltage	$V_{GS(Q)}$	—	-2.7	—		$V_{DS} = 50$ V, $I_D = 800$ mA
Saturated Drain Current	I_{DS}	1.5	2.1	—	A	$V_{DS} = 6.0$ V, $V_{GS} = 2.0$ V
Drain-Source Breakdown Voltage	V_{BR}	84	—	—	V_{DC}	$V_{GS} = -8$ V, $I_D = 132.8$ mA
RF Characteristics² ($T_C = 25^\circ\text{C}$, $F_0 = 5.8$ GHz unless otherwise noted)						
Small Signal Gain	G_{SS}	10	11.8	—	dB	$V_{DD} = 28$ V, $I_{DQ} = 100$ mA
Power Output at $P_{IN} = 30$ dBm	P_{OUT}	5	6.9	—		
Drain Efficiency ³	η	40	53	—	%	$V_{DD} = 28$ V, $I_{DQ} = 200$ mA, $P_{IN} = 30$ dBm
Output Mismatch Stress	VSWR	—	—	10:1	Ψ	No damage at all phase angles, $V_{DD} = 28$ V, $I_{DQ} = 200$ mA, $P_{IN} = 32$ dBm
Dynamic Characteristics						
Input Capacitance	C_{GS}	—	2.7	—	pF	$V_{DS} = 50$ V, $V_{GS} = -8$ V, $f = 1$ MHz
Output Capacitance	C_{DS}	—	0.8	—		
Feedback Capacitance	C_{GD}	—	0.1	—		

Notes:

¹ Measured on wafer prior to packaging.

² Measured in Wolfspeed's narrow band production test fixture AD-000291. This fixture is designed for high volume test at 5.8 GHz and may not show the full capability of the device due to source inductance and thermal performance. The demonstration amplifier, CGH40006S-AMP1, is a better indicator of the true RF performance of the device.

³ Drain Efficiency = P_{OUT} / P_{DC}



Typical Performance

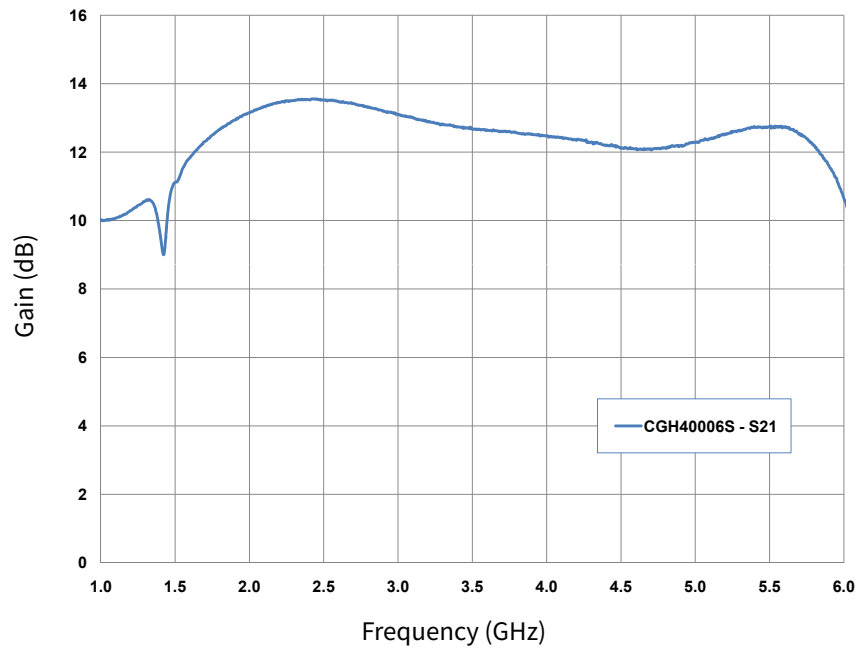

Figure 1. Small Signal Gain vs Frequency at 28 V of the CGH40006S in the CGH40006S-AMP1

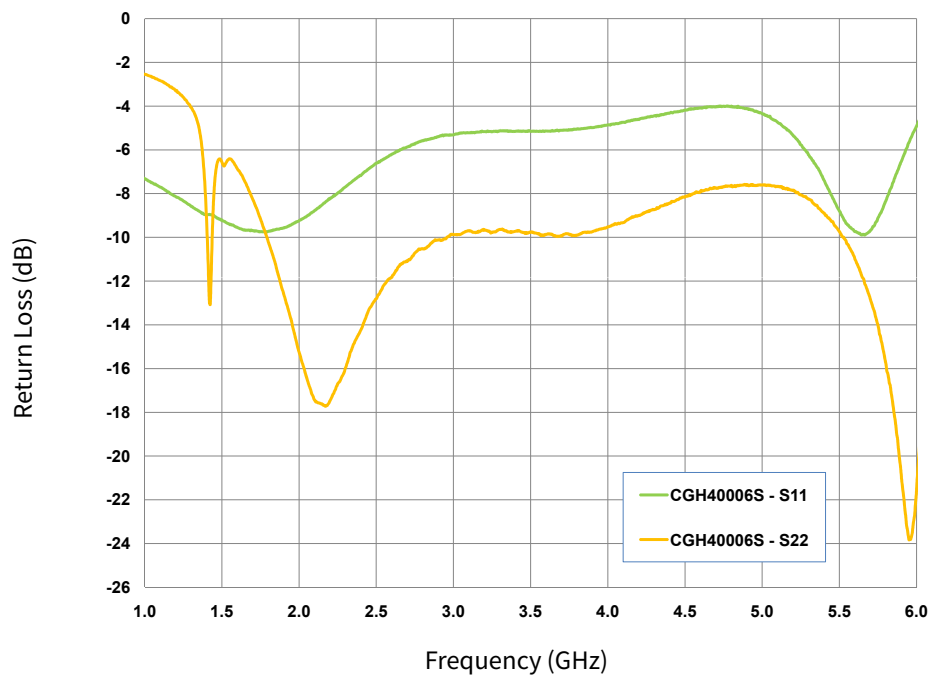

Figure 2. Input & Output Return Losses vs Frequency at 28 V of the CGH40006S in the CGH40006S-AMP1



Typical Performance

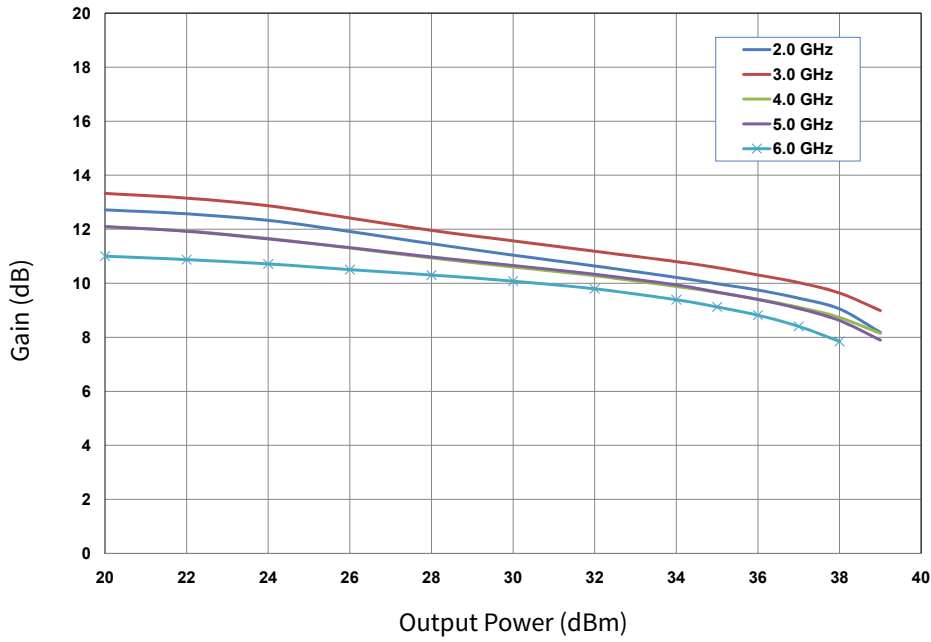

Figure 3. Power Gain vs Output Power as a Function of Frequency of the CGH40006S in the CGH40006S-AMP1
 $V_{DD} = 28\text{ V}$, $I_{DQ} = 100\text{ mA}$

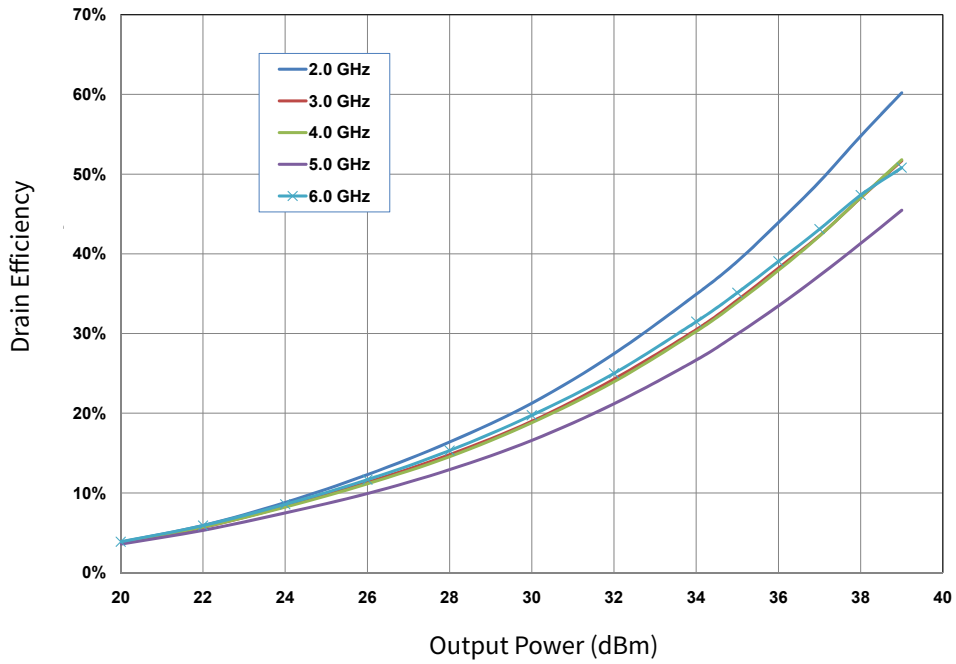

Figure 4. Drain Efficiency vs Output Power as a Function of Frequency of the CGH40006S in the CGH40006S-AMP1
 $V_{DD} = 28\text{ V}$, $I_{DQ} = 100\text{ mA}$



Typical Performance

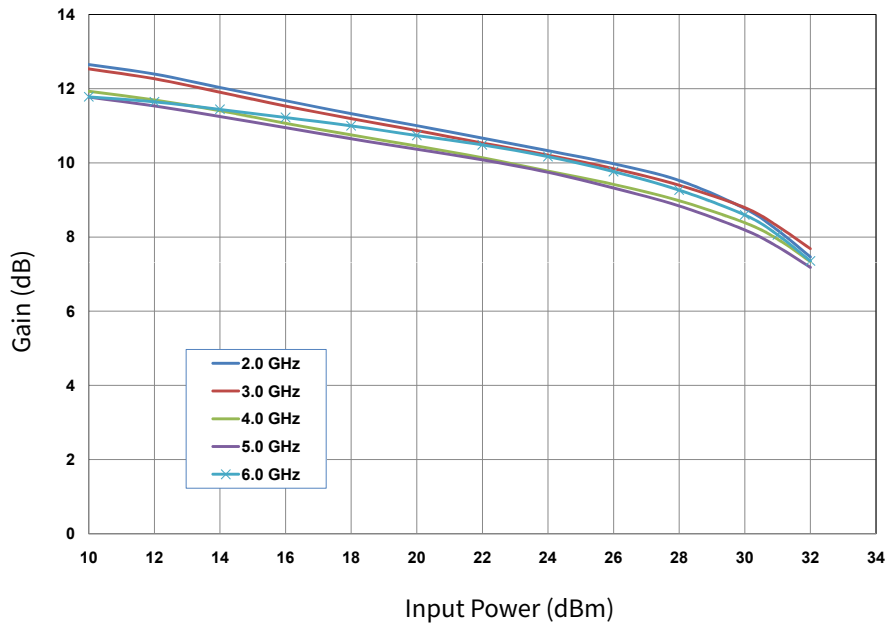

Figure 5. Power Gain vs Input Power as a Function of Frequency of the CGH40006S in the CGH40006S-AMP1
 $V_{DD} = 28\text{ V}$, $I_{DQ} = 100\text{ mA}$

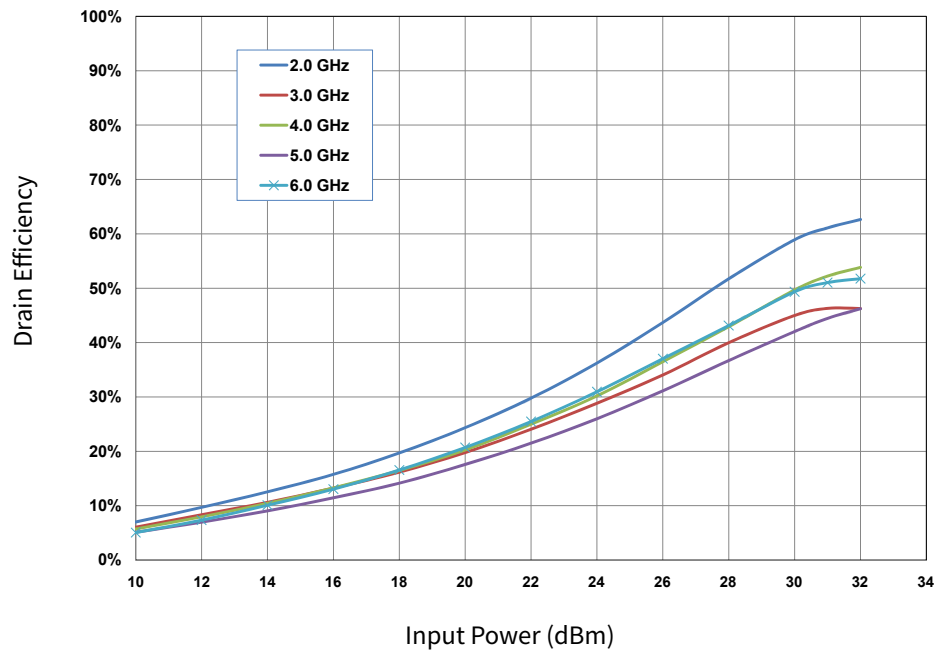

Figure 6. Drain Efficiency vs Input Power as a Function of Frequency of the CGH40006S in the CGH40006S-AMP1
 $V_{DD} = 28\text{ V}$, $I_{DQ} = 100\text{ mA}$



Typical Performance

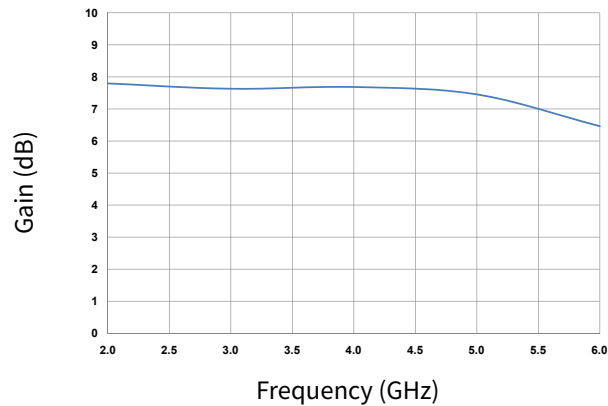

Figure 7. Power Gain vs Frequency of the CGH40006S in the CGH40006S-AMP1 at $P_{IN} = 32$ dBm, $V_{DD} = 28$ V

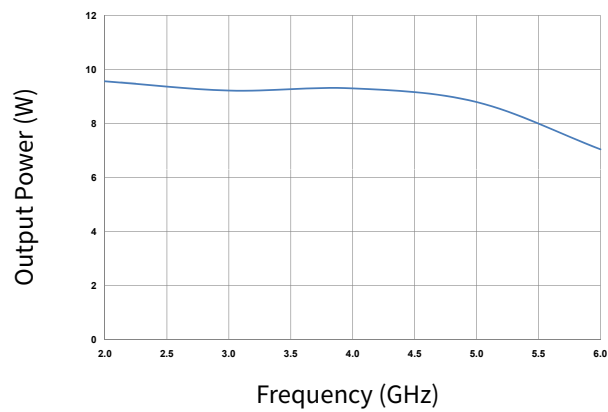

Figure 8. Output Power vs Frequency of the CGH40006S in the CGH40006S-AMP1 at $P_{IN} = 32$ dBm, $V_{DD} = 28$ V

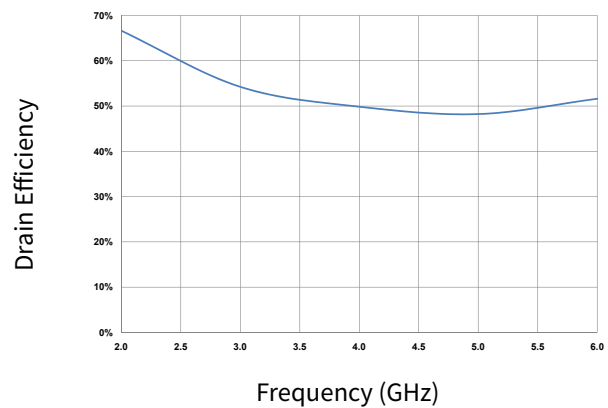

Figure 9. Drain Efficiency vs Frequency of the CGH40006S in the CGH40006S-AMP1 at $P_{IN} = 32$ dBm, $V_{DD} = 28$ V



Typical Noise Performance

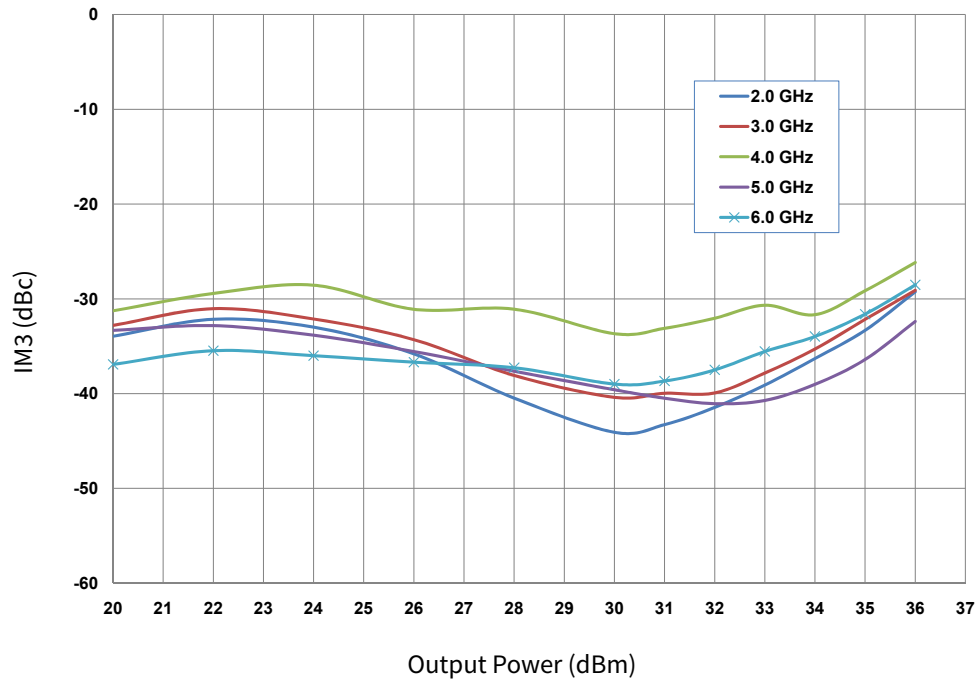

Figure 10. Third Order Intermodulation Distortion vs Average Output Power as a Function of Frequency of the CGH40006S in the CGH40006S-AMP1
 $V_{DD} = 28\text{ V}$, $I_{DQ} = 60\text{ mA}$

Electrostatic Discharge (ESD) Classifications

Parameter	Symbol	Class	Classification Level	Test Methodology
Human Body Model	HBM	TBD	ANSI/ESDA/JEDEC JS-001 Table 3	JEDEC JESD22 A114-D
Charge Device Model	CDM	TBD	ANSI/ESDA/JEDEC JS-001 Table 3	JEDEC JESD22 C101-C

Moisture Sensitivity Level (MSL) Classification

Parameter	Symbol	Level	Test Methodology
Moisture Sensitivity Level	MSL	3 (168 hours)	IPC/JEDEC J-STD-20



Typical Performance

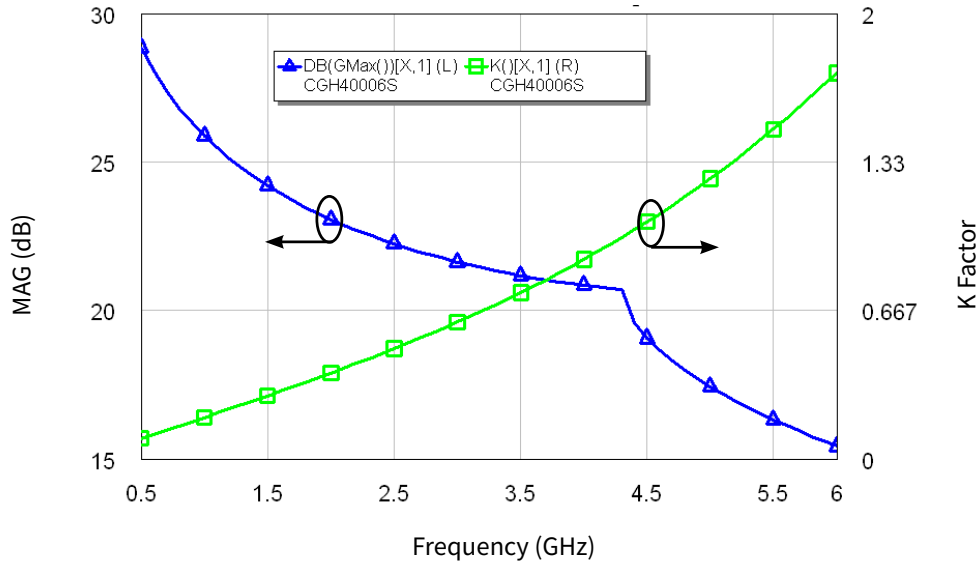

Figure 11. Simulated Maximum Available Gain and K Factor of the CGH40006S $V_{DD} = 28\text{ V}$, $I_{DQ} = 100\text{ mA}$

Note: On a 20 mil thick PCB

Typical Noise Performance

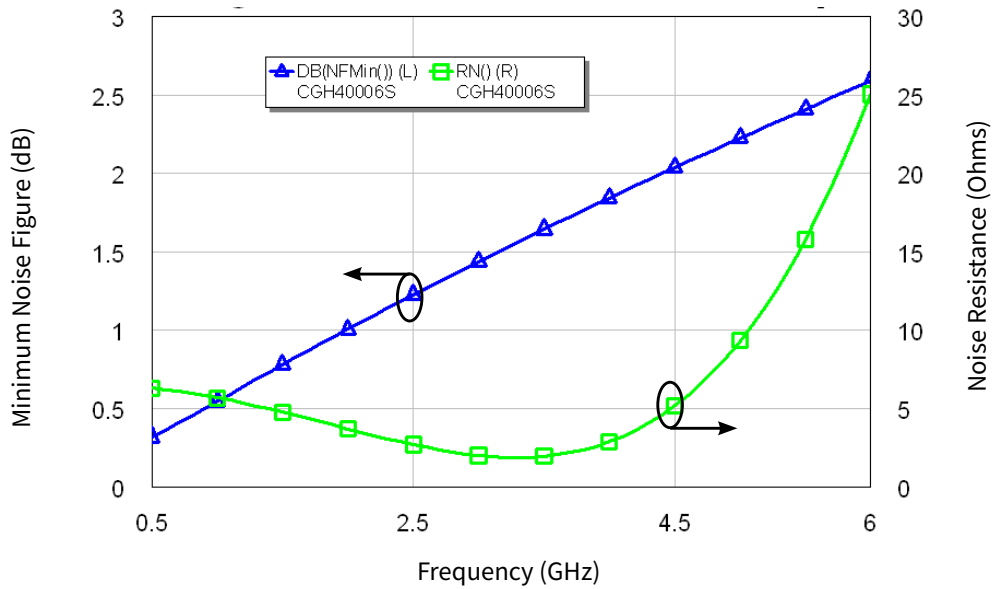
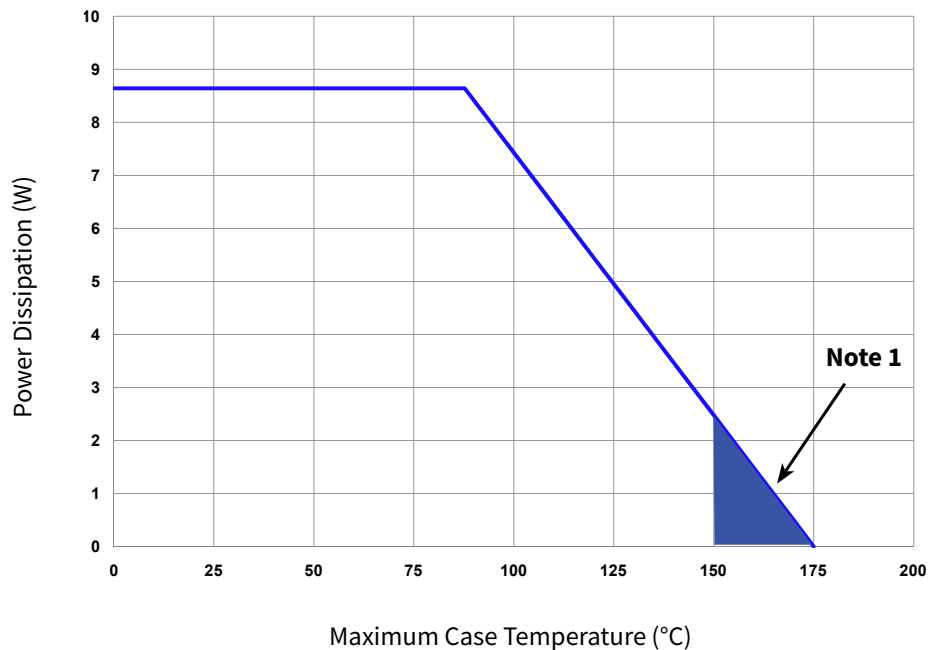

Figure 12. Simulated Minimum Noise Figure and Noise Resistance vs Frequency of the CGH40006S $V_{DD} = 28\text{ V}$, $I_{DQ} = 100\text{ mA}$



CGH40006S CW Power Dissipation De-rating Curve



Note:
¹Area exceeds Maximum Case Operating Temperature (See Page 2).

Source and Load Impedances

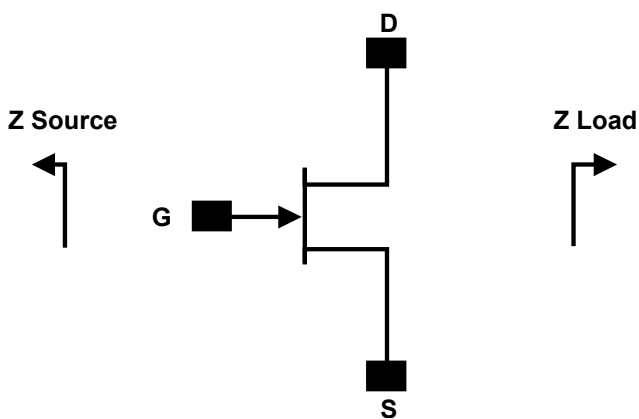

Frequency	Z Source	Z Lead
1000	12.7 + j20.2	62.3 + j42
2000	5.98 + j6.81	32.7 + j32.9
3000	3.32 - j2.89	19.2 + j29.8
4000	2.38 - j9.45	15.2 + j15.7
5000	2.62 - j15.6	9.98 + j9.6
6000	1.94 - j21.35	8.51 + j2.07

Notes:
¹ V_{DD} = 28 V, I_{DQ} = 100 mA in the 440203 package.
² Optimized for power gain, P_{SAT} and PAE
³ When using this device at low frequency, series resistors should be used to maintain amplifier stability.
⁴ 35 pH source inductance is assumed between the package and RF ground (20 mil thick PCB).



CGH40006S-AMP1 Demonstration Amplifier Circuit Bill of Materials

Designator	Description	Qty
R1	RES, AIN, 0505, 470 Ohms ($\leq 5\%$ tolerance)	1
R2	RES, AIN, 0505, 50 Ohms ($\leq 5\%$ tolerance)	1
R3	RES, AIN, 0505, 360 Ohms ($\leq 5\%$ tolerance)	1
C1	CAP, 1.3pF +/-0.1pF, 0603, ATC 600S	1
C2	CAP, 2.7pF +/-0.25pF, 0603, ATC 600S	1
C10	CAP, 3.6pF +/-0.1pF, 0603, ATC 600S	1
C4,C11	CAP, 8.2pF +/-0.25, 0603, ATC 600S	2
C6,C13	CAP, 470pF +/-5%, 0603, 100 V	2
C7,C14	CAP, 33000pF, CER, 100V, X7R, 0805	2
C8	CAP, 10 μ F, 16V, SMT, TANTALUM	1
C15	CAP, 1.0 μ F +/-10%, CER, 100V, X7R, 1210	1
C16	CAP, 33 μ F, 100V, ELECT, FK, SMD	1
J3,J4	CONN, SMA, STR, PANEL, JACK, RECP	2
J1	HEADER RT>PLZ .1CEN LK 5POS	1
-	PCB, RO5880, 0.020" THK	1
Q1	CGH40006S	1

CGH40006S-AMP1 Demonstration Amplifier Circuit

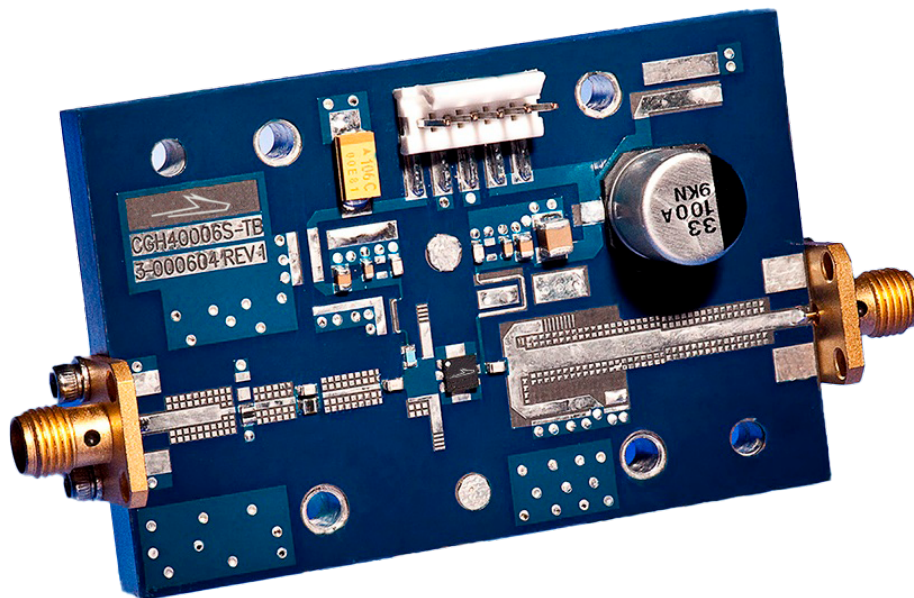



CGH40006S-AMP1 Demonstration Amplifier Circuit Schematic

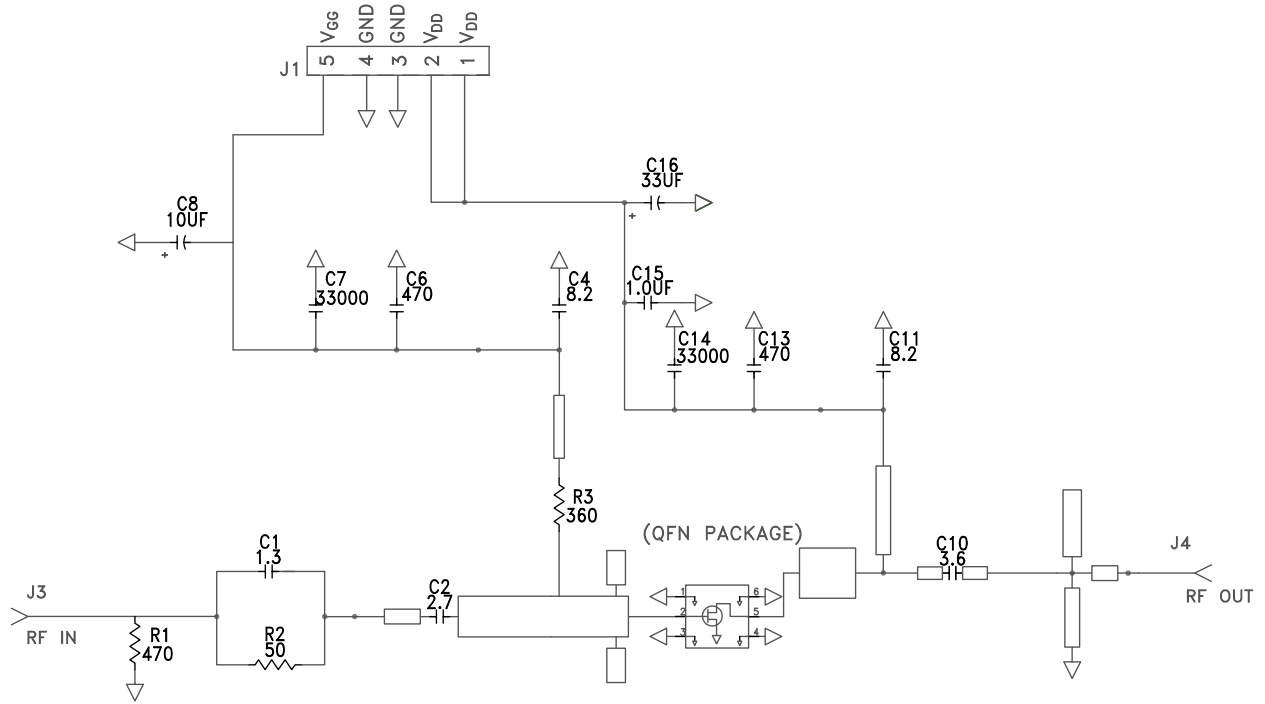

CGH40006S-AMP1 Demonstration Amplifier Circuit Outline

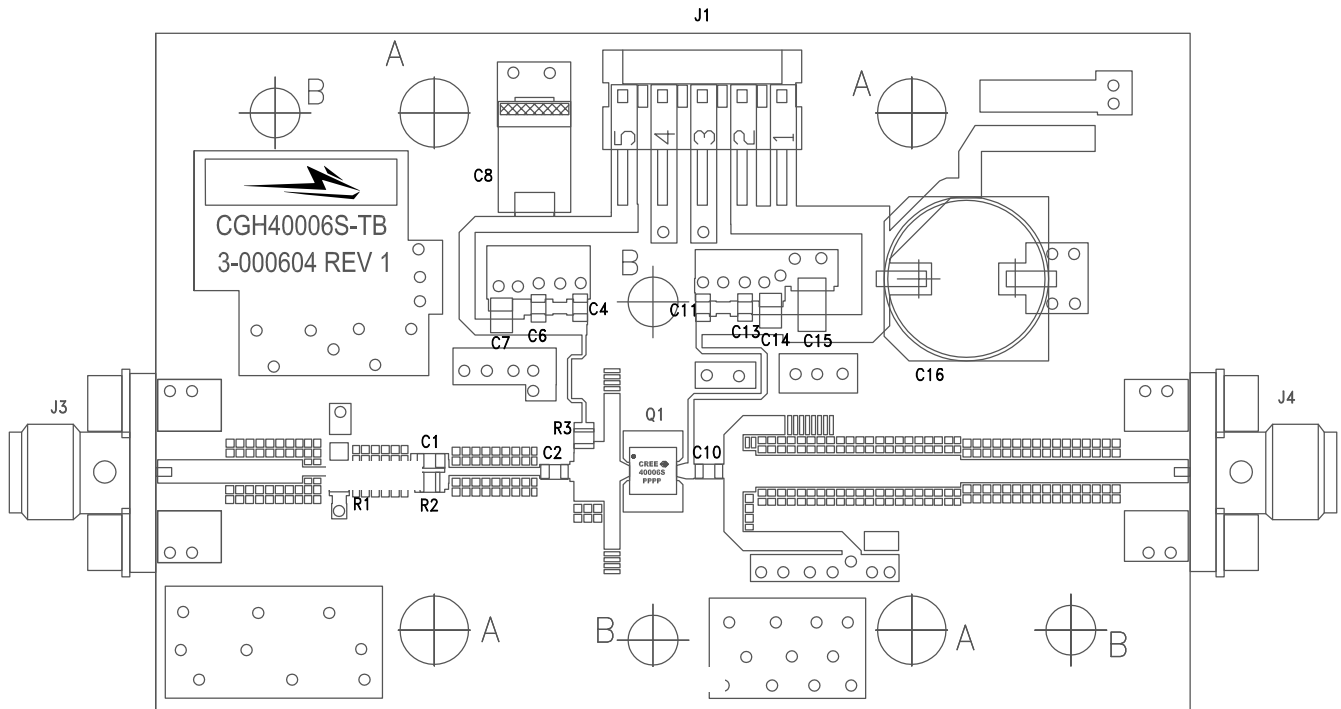



Typical Package S-Parameters for CGH40006S, (Small Signal, $V_{DS} = 28\text{ V}$, $I_{DQ} = 100\text{ mA}$, angle in degrees)

Frequency	Mag S11	Ang S11	Mag S21	Ang S21	Mag S12	Ang S12	Mag S22	Ang S22
500 MHz	0.933	-92.95	18.74	125.47	0.024	38.02	0.459	-48.87
600 MHz	0.922	-104.26	16.89	118.64	0.026	31.70	0.428	-54.78
700 MHz	0.912	-113.77	15.28	112.75	0.028	26.33	0.402	-59.82
800 MHz	0.905	-121.83	13.90	107.61	0.029	21.71	0.381	-64.21
900 MHz	0.899	-128.73	12.70	103.06	0.030	17.68	0.365	-68.10
1.0 GHz	0.894	-134.72	11.67	98.96	0.030	14.11	0.352	-71.62
1.1 GHz	0.891	-139.97	10.77	95.23	0.030	10.91	0.342	-74.86
1.2 GHz	0.888	-144.62	9.99	91.80	0.031	8.00	0.334	-77.87
1.3 GHz	0.886	-148.78	9.31	88.61	0.031	5.34	0.328	-80.72
1.4 GHz	0.884	-152.55	8.71	85.61	0.031	2.88	0.325	-83.43
1.5 GHz	0.883	-155.97	8.17	82.77	0.031	0.58	0.322	-86.03
1.6 GHz	0.881	-159.12	7.69	80.07	0.031	-1.57	0.321	-88.54
1.7 GHz	0.881	-162.04	7.26	77.49	0.031	-3.60	0.321	-90.98
1.8 GHz	0.880	-164.75	6.88	75.00	0.031	-5.53	0.321	-93.35
1.9 GHz	0.879	-167.29	6.53	72.60	0.031	-7.38	0.323	-95.67
2.0 GHz	0.879	-169.68	6.21	70.26	0.031	-9.14	0.325	-97.94
2.1 GHz	0.879	-171.94	5.92	68.00	0.030	-10.83	0.327	-100.17
2.2 GHz	0.879	-174.09	5.65	65.79	0.030	-12.46	0.330	-102.36
2.3 GHz	0.879	-176.14	5.40	63.62	0.030	-14.03	0.334	-104.51
2.4 GHz	0.879	-178.10	5.18	61.51	0.030	-15.55	0.338	-106.63
2.5 GHz	0.879	-179.98	4.97	59.43	0.030	-17.02	0.342	-108.71
2.6 GHz	0.879	178.20	4.77	57.38	0.029	-18.44	0.346	-110.77
2.7 GHz	0.879	176.44	4.59	55.37	0.029	-19.83	0.351	-112.81
2.8 GHz	0.879	174.74	4.42	53.39	0.029	-21.18	0.355	-114.82
2.9 GHz	0.879	173.09	4.26	51.43	0.029	-22.48	0.360	-116.80
3.0 GHz	0.880	171.49	4.11	49.50	0.028	-23.76	0.366	-118.76
3.2 GHz	0.880	168.39	3.84	45.70	0.028	-26.20	0.376	-122.63
3.4 GHz	0.881	165.43	3.60	41.97	0.027	-28.51	0.387	-126.41
3.6 GHz	0.882	162.57	3.38	38.31	0.026	-30.70	0.399	-130.13
3.8 GHz	0.883	159.81	3.19	34.71	0.025	-32.75	0.410	-133.78
4.0 GHz	0.884	157.13	3.01	31.16	0.025	-34.68	0.422	-137.38
4.2 GHz	0.885	154.52	2.85	27.65	0.024	-36.47	0.433	-140.91
4.4 GHz	0.887	151.96	2.71	24.19	0.023	-38.12	0.445	-144.40
4.6 GHz	0.888	149.45	2.57	20.77	0.022	-39.63	0.457	-147.84
4.8 GHz	0.889	146.98	2.45	17.38	0.022	-40.97	0.468	-151.24
5.0 GHz	0.890	144.55	2.33	14.03	0.021	-42.15	0.480	-154.60
5.2 GHz	0.892	142.15	2.23	10.71	0.020	-43.15	0.491	-157.92
5.4 GHz	0.893	139.78	2.13	7.41	0.019	-43.95	0.503	-161.20
5.6 GHz	0.894	137.43	2.04	4.15	0.018	-44.53	0.514	-164.45
5.8 GHz	0.896	135.11	1.95	0.91	0.018	-44.89	0.525	-167.66
6.0 GHz	0.897	132.80	1.87	-2.30	0.017	-45.00	0.535	-170.85

To download the s-parameters in s2p format, go to the [CGH40006S Product Page](#) and click on the documentation tab.

Note: On a 20 mil thick PCB.



Product Dimensions CGH40006S (Package Type — 440203)

DIM	MILLIMETERS			INCHES		
	MIN	NOM	MAX	MIN	NOM	MAX
A	0.80	0.90	1.00	0.032	0.035	0.039
A1	0	0.02	0.05	0	0.0008	0.002
A3	---	0.20REF.	---	---	0.008REF.	---
b	0.30	0.40	0.45	0.012	0.016	0.018
D	---	3.00BSC	---	---	0.118BSC	---
D1	---	2.34BSC	---	---	0.092BSC	---
E	---	3.00BSC	---	---	0.118BSC	---
E1	---	1.57BSC	---	---	0.062BSC	---
e	---	0.95BSC	---	---	0.037BSC	---
L	0.20	0.30	0.45	0.008	0.012	0.018
ø	0	---	12	0	---	12
M	---	---	0.05	---	---	0.002
N	6					
NE	3					

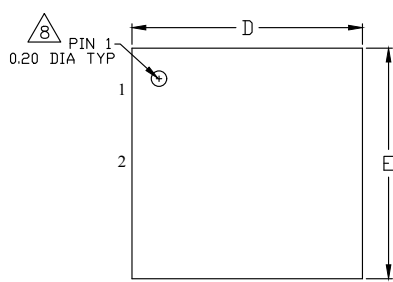

TOP VIEW

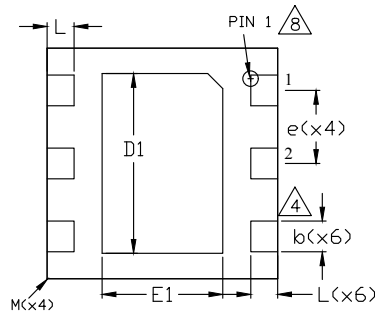

BOTTOM VIEW

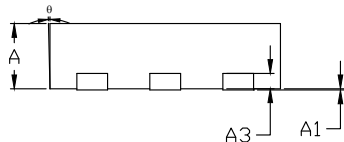

SIDE VIEW

Pin	Input/Output
1	GND
2	RF IN
3	GND
4	GND
5	RF OUT
6	GND

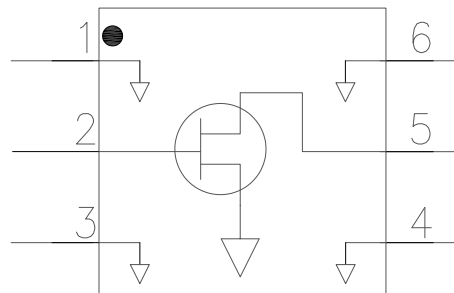

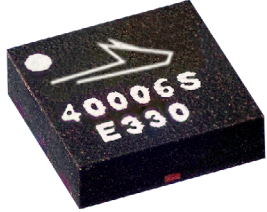
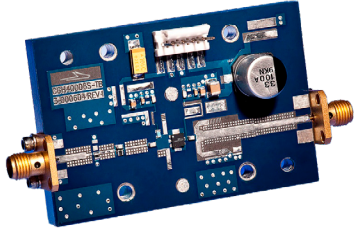

Product Ordering Information

Order Number	Description	Unit of Measure	Image
CGH40006S	GaN HEMT	Each	 A black, square GaN HEMT chip with a white arrow logo and the text '40006S E330' printed on its surface.
CGH40006S-AMP1	Test board with GaN HEMT installed	Each	 A blue printed circuit board (PCB) populated with various electronic components, including a central GaN HEMT chip, capacitors, and connectors.

**For more information, please contact:**

4600 Silicon Drive
Durham, NC 27703 USA
Tel: +1.919.313.5300
www.wolfspeed.com/RF

Sales Contact
RFSales@wolfspeed.com

RF Product Marketing Contact
RFMarketing@wolfspeed.com

Notes & Disclaimer

Specifications are subject to change without notice. “Typical” parameters are the average values expected by Wolfspeed in large quantities and are provided for information purposes only. Wolfspeed products are not warranted or authorized for use as critical components in medical, life-saving, or life-sustaining applications, or other applications where a failure would reasonably be expected to cause severe personal injury or death. No responsibility is assumed by Wolfspeed for any infringement of patents or other rights of third parties which may result from use of the information contained herein. No license is granted by implication or otherwise under any patent or patent rights of Wolfspeed.

©2010-2022 Wolfspeed, Inc. All rights reserved. Wolfspeed® and the Wolfstreak logo are registered trademarks and the Wolfspeed logo is a trademark of Wolfspeed, Inc.
PATENT: <https://www.wolfspeed.com/legal/patents>

The information in this document is subject to change without notice.