

# LTM4656

## 6V to 36V Input, 24V Output, Short-Circuit Protected Synchronous Boost $\mu$ Module Regulator

### DESCRIPTION

Demonstration circuit 2634A is a boost  $\mu$ Module regulator featuring the LTM4656. The DC2634A operates from 6V to 36V input and generates 24V, 4A output from 12V input. When  $V_{IN} \geq 24V$ ,  $V_{OUT}$  follows  $V_{IN}$ . Also, the LTM<sup>®</sup>4656 has precision voltage reference, which can generate output voltage with 2% tolerance over the full operating conditions. The 400kHz switching frequency operation results in small and efficient circuit. The converter achieves over 95% efficiency with 4A load. The LTM4656 protects the

load with the integrated soft-start and output short-circuit protection functions. The demonstration circuit can be easily modified to regulate different output voltages.

The DC2634A has small circuit footprint. It is a high performance and cost-effective solution for generating output voltages up to 36V from inputs as low as 5V.

**[Design files for this circuit board are available.](#)**

All registered trademarks and trademarks are the property of their respective owners.

### PERFORMANCE SUMMARY Specifications are at $T_A = 25^\circ C$

PARAMETER	CONDITIONS	MIN	TYP	MAX	UNITS
Minimum Input Voltage	$I_{OUT} = 0A$ to 1.3A		6		V
Minimum Input Voltage to Support Full Load	$I_{OUT} = 4A$		12		V
Maximum Input Voltage (Output Follows $V_{IN}$ above 24V Input)	$I_{OUT} = 0A$ to 4A		36		V
$V_{OUT}$	$V_{IN} = 6V$ to 23V, $I_{OUT} = 0A$		24 $\pm 2\%$		V
Output Voltage Ripple	$V_{IN} = 6V$ , $I_{OUT} = 1A$		300		mV <sub>P-P</sub>
Nominal Switching Frequency			400		kHz

### BOARD PHOTO

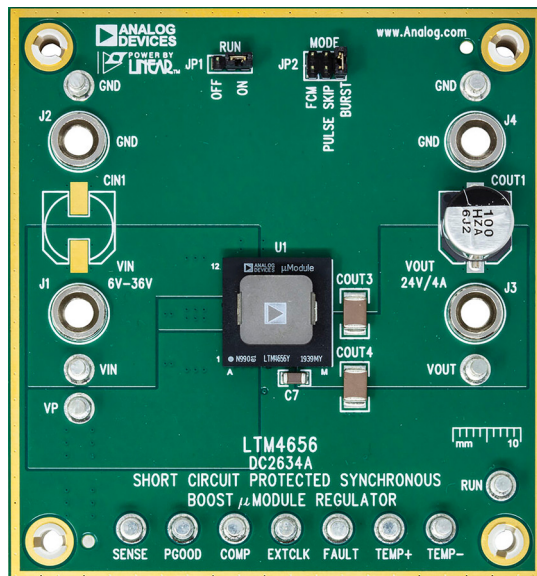

# DEMO MANUAL DC2634A

## QUICK START PROCEDURE

Demonstration circuit 2634A is easy to set up to evaluate the performance of the LTM4656. For proper measurement equipment setup refer to Figure 1 and follow the procedure below:

NOTE: When measuring the input or output voltage ripple, care must be taken to minimize the length of oscilloscope probe ground lead. Measure the input or output voltage ripple by connecting the probe tip directly across the VIN or VOUT and GND terminals as shown in Figure 2.

1. With power off, connect the input power supply to VIN and GND.
2. Keep the load set to 0A or disconnected.

3. Turn the input power source on and slowly increase the input voltage. Be careful not to exceed 36V.

NOTE: Make sure that the input voltage  $V_{IN}$  does not exceed 36V.

4. Set the input voltage to 12V and check for the proper output voltage of 24V. If there is no output, temporarily disconnect the load to make sure that the load is not set too high.
5. Once the proper output voltage is established, adjust the load and observe the output voltage regulation, ripple voltage, efficiency and other parameters.

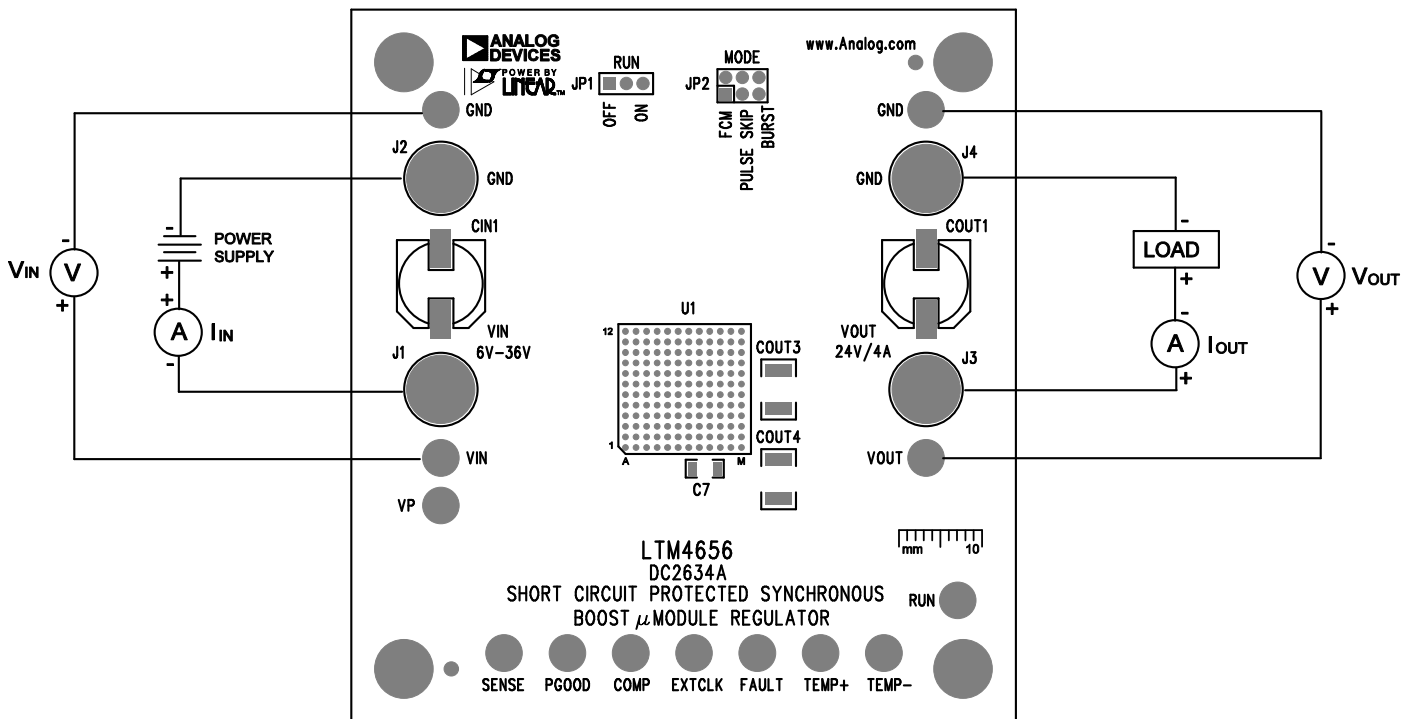

Figure 1. Proper Measurement Equipment Setup

## QUICK START PROCEDURE

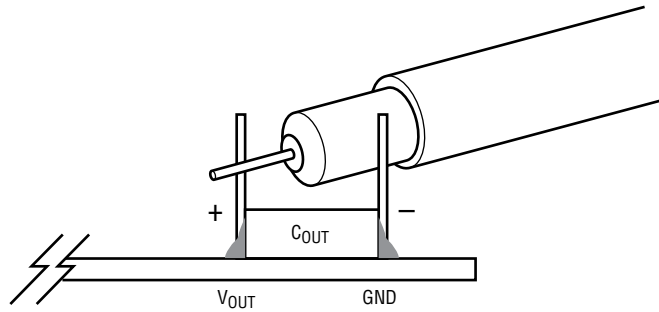

Figure 2. Measuring Input or Output Ripple

### Changing the Output Voltage

To change the output voltage from the programmed 24V, change the voltage setting resistors connected to LTM4656 FB pin (see Schematic Diagram section).

### Converter Output Current

The DC2634A output current depends on the input voltage and programmed input current limit. Typical performance of DC2634A is shown in Figure 3. From Figure 3, the maximum output current is 4A with 12V input. Switching the mode of operation to BURST mode can increase the efficiency at light loads.

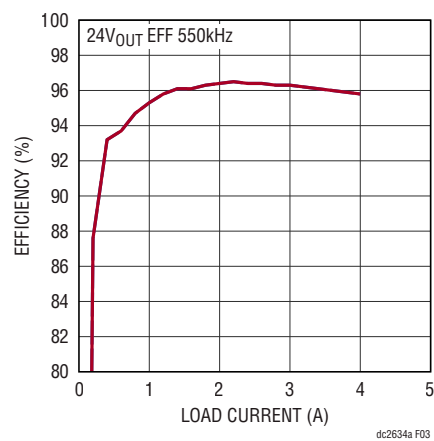
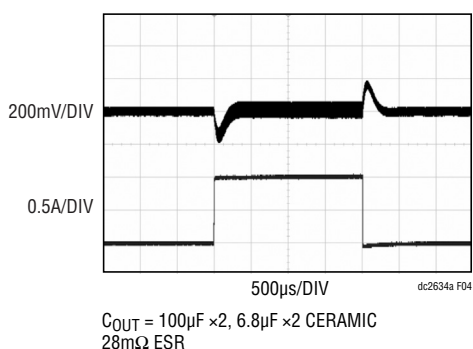

Figure 3. The 12V Input Efficiency Is Over 96% at 3A Load

## QUICK START PROCEDURE

### Output Load Step Response

The load step response of DC2634A is dependent on the amount and type of output caps used. For higher load steps more output capacitance can be added to keep the voltage transients at the desired level. The 1A load step transients with 12V input are shown in Figure 4. Other types of low ESR and high value capacitors can be used if space is available to reduce load transients to desired level.



**Figure 4. The LTM4656 Has Good Load Step Response with Small Output Capacitors**

### Startup and Soft-Start Function

The DC2634A features internal soft start circuit that ramps the output voltage up in monotonic fashion. The soft start circuit also prevents output voltage overshoot when output voltage ramp reaches regulation.

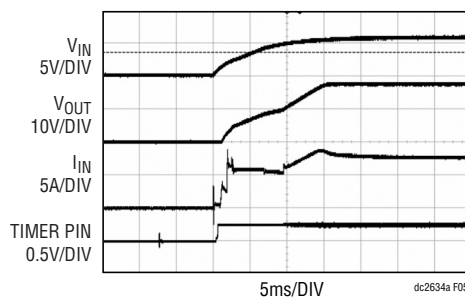

**Figure 5. The DC2634A Ramps the Output Slowly at Startup without Output Voltage Overshoot**

### Short-Circuit Protection

The LTM4656 features safe short-circuit protection. The part will limit the input current to around 5A when output is shorted as shown in Figure 6. Also, the internal timer

## QUICK START PROCEDURE

circuit will turn internal protection MOSFET off for programmed time in order to reduce the power dissipation during short-circuit. Following over current event the part will enter cooldown period of 33ms with the internal 10nF timer capacitor. The part will try to startup again after the cooldown period.

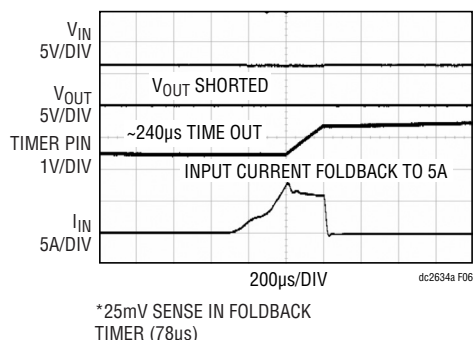

**Figure 6. The DC2634A Overcurrent Protection Limits Input Current to 5A During Short-Circuit Condition**

## Thermal Performance

The LTM4656 features excellent thermal performance due to high efficiency of internal synchronous boost circuit. The temperature rises of LTM4656 with 12V input and 4A load is shown in Figure 7.

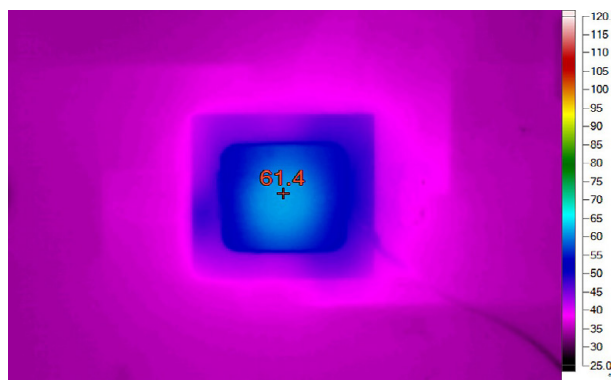

**Figure 7. The LTM4656 Has Only 41.4°C Temperature Rise with 12V Input, 24V Output with 4A Load. ( $T_A = 25^\circ\text{C}$ , No Cooling Fan)**

# DEMO MANUAL DC2634A

## PARTS LIST

ITEM	QTY	REFERENCE	PART DESCRIPTION	MANUFACTURER/PART NUMBER
<b>Required Circuit Components</b>				
1	3	C1, COUT1, COUT2	CAP, 100µF, ALUM POLY HYB, 50V, 20%, 10mm × 10.2mm, G, SMD, RADIAL, AEC-Q200	PANASONIC, EEHZA1H101P
2	7	C2, CIN2, CIN3, COUT3, COUT4, COUT5, COUT6	CAP, 6.8µF, X7R, 50V, 10%, 1812	TDK, C4532X7R1H685K250KB
3	2	C3, C7	CAP, 4.7µF, X7R, 50V, 10%, 1206	AVX, 12065C475KAT2A MURATA, GRM31CR71H475KA12L NIC, NMC1206X7R475K50TRPLPF TDK, C3216X7R1H475K160AC
4	1	C4	CAP, 4.7µF, X5R, 16V, 10%, 0603	AVX, 0603YD475KAT2A MURATA, GRM188R61C475KAAJD MURATA, GRM188R61C475KE11D TDK, C1608X5R1C475K080AC
5	1	C5	CAP, 0.1µF, X5R, 25V, 10%, 0603, NO SUBS. ALLOWED	AVX, 06033D104KAT2A
6	1	D1	DIODE, SCHOTTKY RECTIFIER, 45V, 5A, SMA-FL	ON SEMICONDUCTOR, NTSAF545T3G
7	1	R1	RES., 100k, 1%, 1/10W, 0603, AEC-Q200	NIC, NRC06F1003TRF PANASONIC, ERJ3EKF1003V VISHAY, CRCW0603100KFKEA
8	1	R2	RES., 4.99k, 1%, 1/10W, 0603, AEC-Q200	NIC, NRC06F4991TRF PANASONIC, ERJ3EKF4991V VISHAY, CRCW06034K99FKEA
9	1	R3	RES., 60.4k, 1%, 1/10W, 0603, AEC-Q200	PANASONIC, ERJ3EKF6042V VISHAY, CRCW060360K4FKEA
10	1	R4	RES., 30.1k, 1%, 1/10W, 0603, AEC-Q200	PANASONIC, ERJ3EKF3012V VISHAY, CRCW060330K1FKEA
11	1	R5	RES., 11.5k, 1%, 1/10W, 0603, AEC-Q200	VISHAY, CRCW060311K5FKEA
12				
13	1	U1	IC, µModule REG WITH INPUT PROTECTION, BGA-144	ANALOG DEVICES INC., LTM4656EY#PBF
<b>Additional Demo Board Circuit Components</b>				
1	0	CIN1	CAP, OPTION, 10mm × 10.2mm	
2	0	C6, C8	CAP, OPTION, 0603	
3	0	R6	RES., OPTION, 0603	

**SCHEMATIC DIAGRAM**

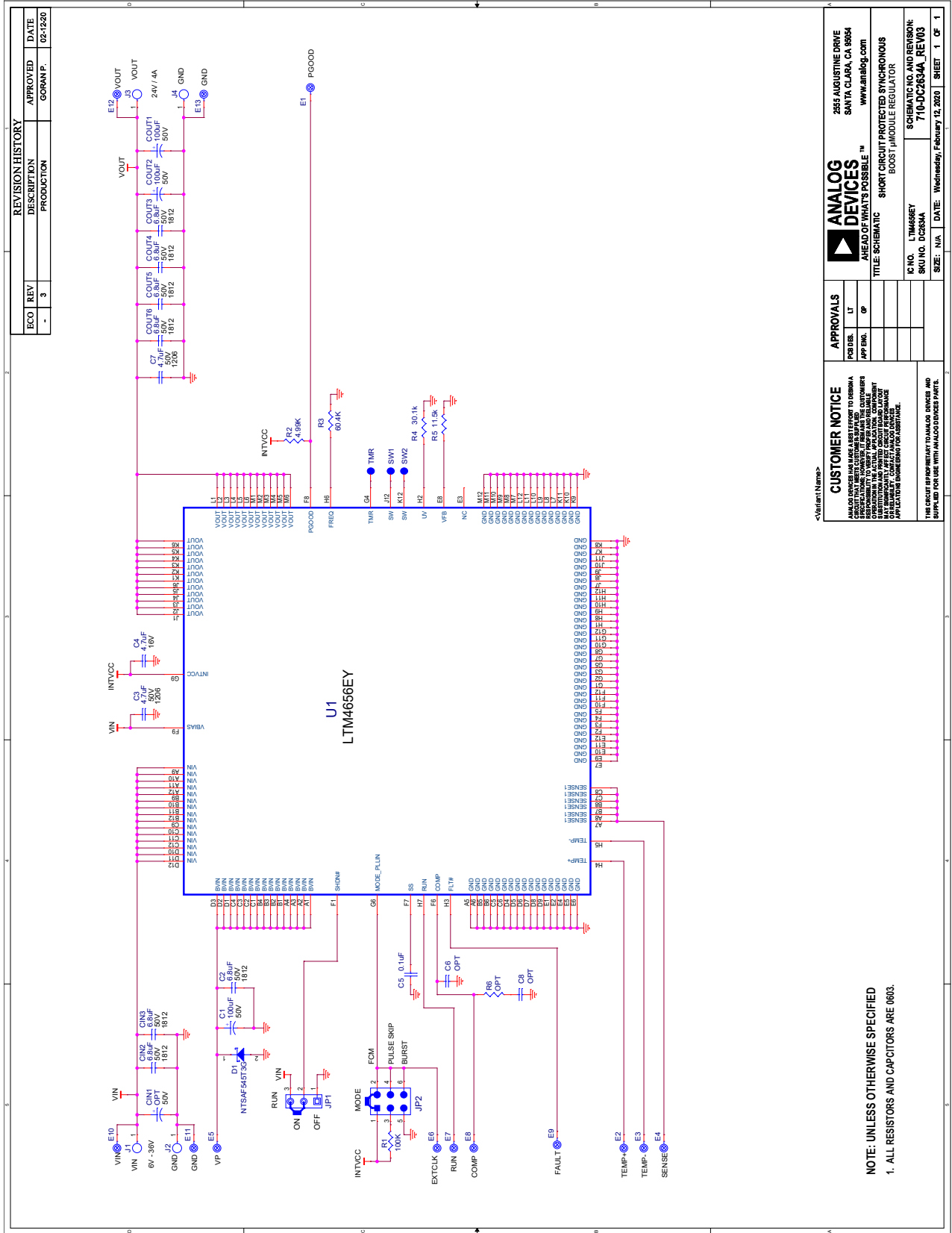



## ESD Caution

**ESD (electrostatic discharge) sensitive device.** Charged devices and circuit boards can discharge without detection. Although this product features patented or proprietary protection circuitry, damage may occur on devices subjected to high energy ESD. Therefore, proper ESD precautions should be taken to avoid performance degradation or loss of functionality.

## Legal Terms and Conditions

By using the evaluation board discussed herein (together with any tools, components documentation or support materials, the "Evaluation Board"), you are agreeing to be bound by the terms and conditions set forth below ("Agreement") unless you have purchased the Evaluation Board, in which case the Analog Devices Standard Terms and Conditions of Sale shall govern. Do not use the Evaluation Board until you have read and agreed to the Agreement. Your use of the Evaluation Board shall signify your acceptance of the Agreement. This Agreement is made by and between you ("Customer") and Analog Devices, Inc. ("ADI"), with its principal place of business at One Technology Way, Norwood, MA 02062, USA. Subject to the terms and conditions of the Agreement, ADI hereby grants to Customer a free, limited, personal, temporary, non-exclusive, non-sublicensable, non-transferable license to use the Evaluation Board FOR EVALUATION PURPOSES ONLY. Customer understands and agrees that the Evaluation Board is provided for the sole and exclusive purpose referenced above, and agrees not to use the Evaluation Board for any other purpose. Furthermore, the license granted is expressly made subject to the following additional limitations: Customer shall not (i) rent, lease, display, sell, transfer, assign, sublicense, or distribute the Evaluation Board; and (ii) permit any Third Party to access the Evaluation Board. As used herein, the term "Third Party" includes any entity other than ADI, Customer, their employees, affiliates and in-house consultants. The Evaluation Board is NOT sold to Customer; all rights not expressly granted herein, including ownership of the Evaluation Board, are reserved by ADI. CONFIDENTIALITY. This Agreement and the Evaluation Board shall all be considered the confidential and proprietary information of ADI. Customer may not disclose or transfer any portion of the Evaluation Board to any other party for any reason. Upon discontinuation of use of the Evaluation Board or termination of this Agreement, Customer agrees to promptly return the Evaluation Board to ADI. ADDITIONAL RESTRICTIONS. Customer may not disassemble, decompile or reverse engineer chips on the Evaluation Board. Customer shall inform ADI of any occurred damages or any modifications or alterations it makes to the Evaluation Board, including but not limited to soldering or any other activity that affects the material content of the Evaluation Board. Modifications to the Evaluation Board must comply with applicable law, including but not limited to the RoHS Directive. TERMINATION. ADI may terminate this Agreement at any time upon giving written notice to Customer. Customer agrees to return to ADI the Evaluation Board at that time. LIMITATION OF LIABILITY. THE EVALUATION BOARD PROVIDED HEREUNDER IS PROVIDED "AS IS" AND ADI MAKES NO WARRANTIES OR REPRESENTATIONS OF ANY KIND WITH RESPECT TO IT. ADI SPECIFICALLY DISCLAIMS ANY REPRESENTATIONS, ENDORSEMENTS, GUARANTEES, OR WARRANTIES, EXPRESS OR IMPLIED, RELATED TO THE EVALUATION BOARD INCLUDING, BUT NOT LIMITED TO, THE IMPLIED WARRANTY OF MERCHANTABILITY, TITLE, FITNESS FOR A PARTICULAR PURPOSE OR NON-INFRINGEMENT OF INTELLECTUAL PROPERTY RIGHTS. IN NO EVENT WILL ADI AND ITS LICENSORS BE LIABLE FOR ANY INCIDENTAL, SPECIAL, INDIRECT, OR CONSEQUENTIAL DAMAGES RESULTING FROM CUSTOMER'S POSSESSION OR USE OF THE EVALUATION BOARD, INCLUDING BUT NOT LIMITED TO LOST PROFITS, DELAY COSTS, LABOR COSTS OR LOSS OF GOODWILL. ADI'S TOTAL LIABILITY FROM ANY AND ALL CAUSES SHALL BE LIMITED TO THE AMOUNT OF ONE HUNDRED US DOLLARS (\$100.00). EXPORT. Customer agrees that it will not directly or indirectly export the Evaluation Board to another country, and that it will comply with all applicable United States federal laws and regulations relating to exports. GOVERNING LAW. This Agreement shall be governed by and construed in accordance with the substantive laws of the Commonwealth of Massachusetts (excluding conflict of law rules). Any legal action regarding this Agreement will be heard in the state or federal courts having jurisdiction in Suffolk County, Massachusetts, and Customer hereby submits to the personal jurisdiction and venue of such courts. The United Nations Convention on Contracts for the International Sale of Goods shall not apply to this Agreement and is expressly disclaimed.