

CRYSTAL-MINE

~4.9° spot beam especially designed for mining headlamps. Assembly with holder.

SPECIFICATION:

Dimensions	Ø 50.3 mm
Height	28.7 mm
Fastening	pin, screw
ROHS compliant	yes ⓘ



MATERIALS:

Component	Type	Material	Colour	Finish
F12985_CRYSTAL-MINE	Single lens	PMMA	clear	
C13478_CRYSTAL-HLD	Holder	PC	white	

ORDERING INFORMATION:

Quantities for one set:

Single lens	1
Holder	1

Component		Qty in box	MOQ	MPQ	Box weight (kg)
F12985_CRYSTAL-MINE	Single lens	288	64	32	7.1
» Box size: 480 x 280 x 300 mm					
C13478_CRYSTAL-HLD	Holder	1152	64	32	6.1
» Box size: 480 x 280 x 300 mm					

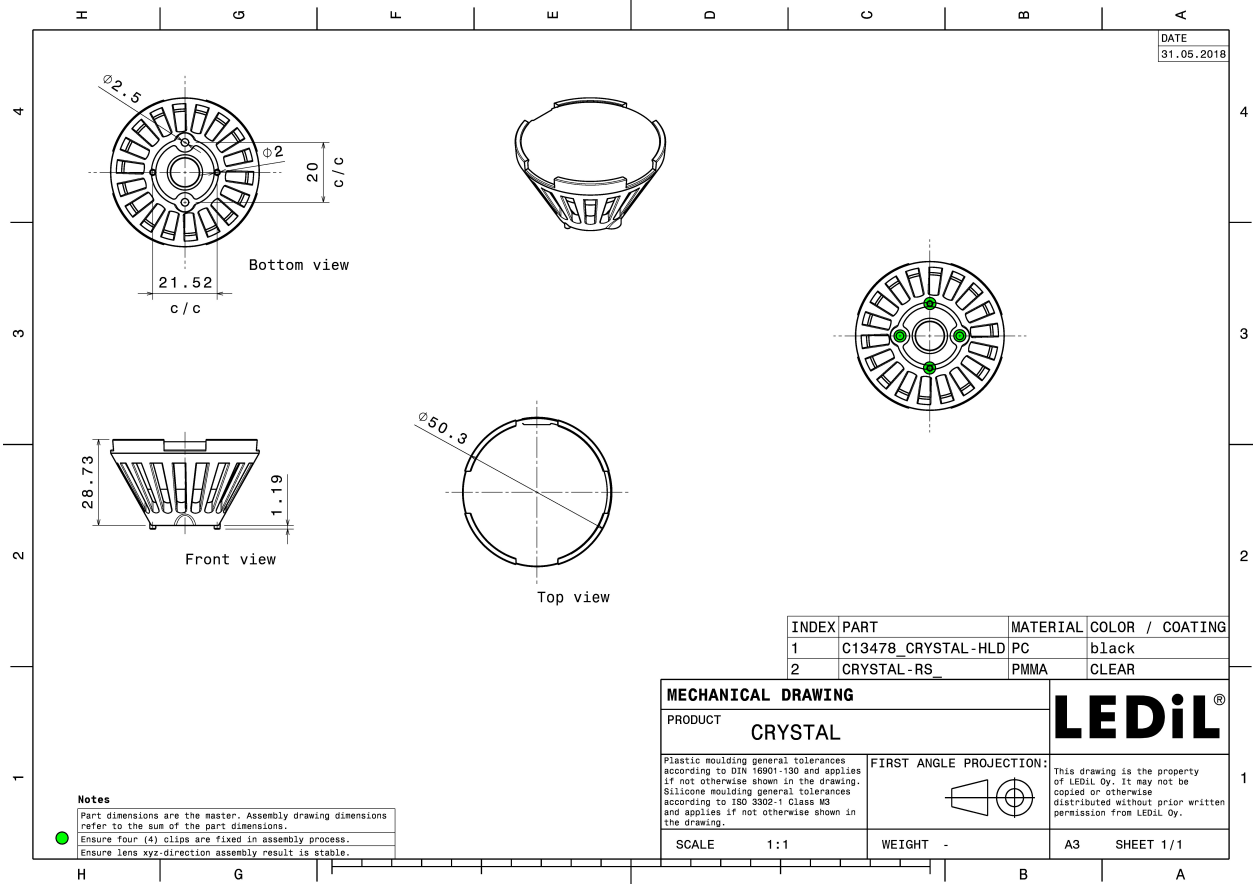

See also our general installation guide: www.ledil.com/installation_guide

OPTICAL RESULTS (MEASURED):

CREE LED

LED XP-G
 FWHM / FWTM 4.7° / 10.5°
 Efficiency 90 %
 Peak intensity 66.9 cd/lm
 LEDs/each optic 1
 Light colour White
 Required components:

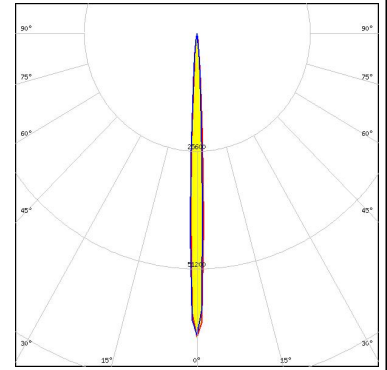

CREE LED

LED XP-G2
 FWHM / FWTM 4.6° / 12.0°
 Efficiency 90 %
 Peak intensity 65.2 cd/lm
 LEDs/each optic 1
 Light colour White
 Required components:

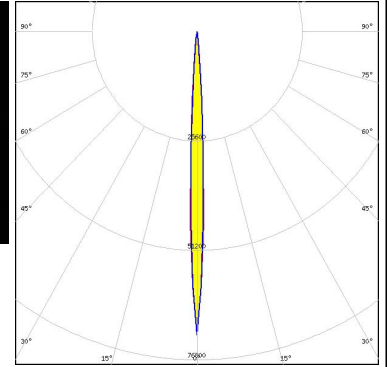

CREE LED

LED XP-L HD
 FWHM / FWTM 7.0° / 14.0°
 Efficiency 86 %
 Peak intensity 33 cd/lm
 LEDs/each optic 1
 Light colour White
 Required components:

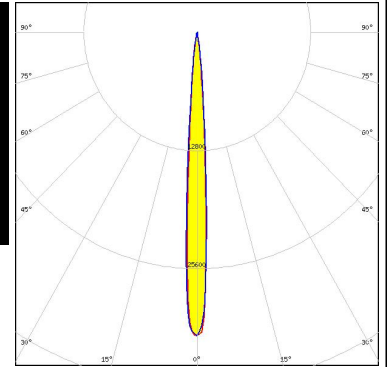

CREE LED

LED XP-L HI
 FWHM / FWTM 4.5° / 12.0°
 Efficiency 92 %
 Peak intensity 60 cd/lm
 LEDs/each optic 1
 Light colour White
 Required components:

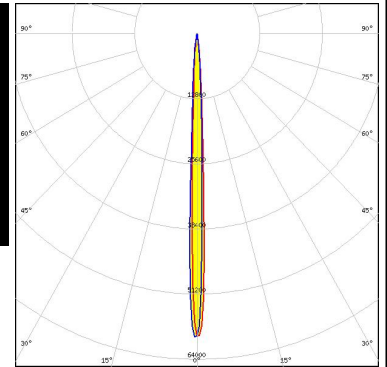

OPTICAL RESULTS (MEASURED):

LUMILEDS

LED LUXEON 5050 Round LES
 FWHM / FWTM 9.0° / 23.0°
 Efficiency 94 %
 Peak intensity 17.5 cd/lm
 LEDs/each optic 1
 Light colour White
 Required components:

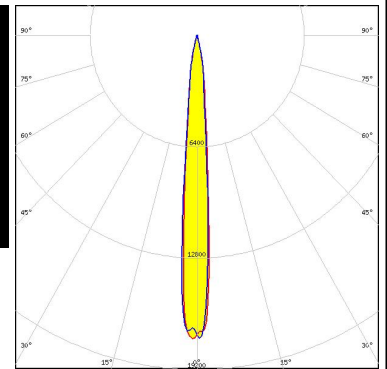
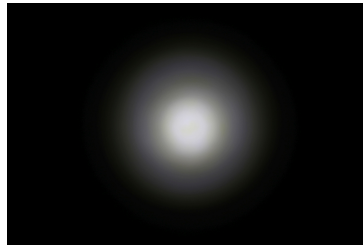

LUMILEDS

LED LUXEON A
 FWHM / FWTM 4.9° / 13.0°
 Efficiency 89 %
 Peak intensity 58.2 cd/lm
 LEDs/each optic 1
 Light colour White
 Required components:



LUMILEDS

LED LUXEON T
 FWHM / FWTM 4.9° / 13.0°
 Efficiency 89 %
 Peak intensity 55.1 cd/lm
 LEDs/each optic 1
 Light colour White
 Required components:





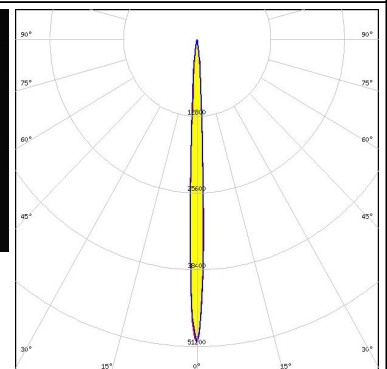

LUMILEDS

LED LUXEON TX
 FWHM / FWTM 5.0° / 12.6°
 Efficiency 94 %
 Peak intensity 50.6 cd/lm
 LEDs/each optic 1
 Light colour White
 Required components:

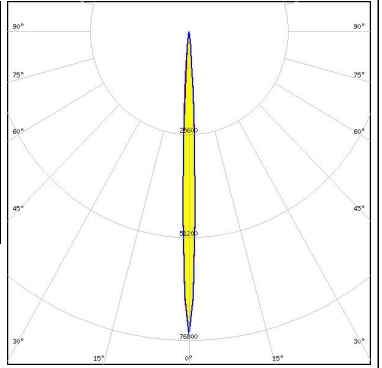

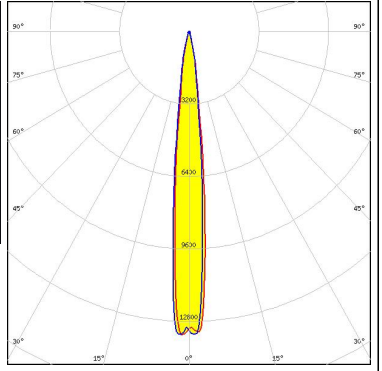
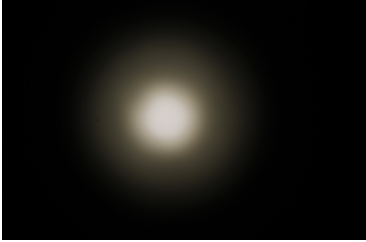
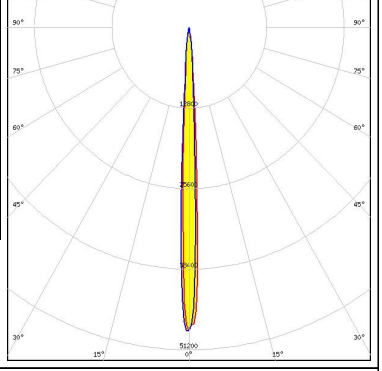
OPTICAL RESULTS (MEASURED):

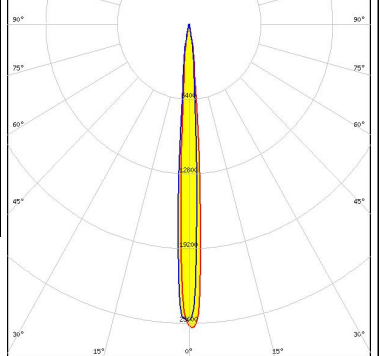
<p>NICHIA</p> <p>LED NCSxx19B FWHM / FWTM 3.6° / 12.0° Efficiency 90 % Peak intensity 73.3 cd/lm LEDs/each optic 1 Light colour White Required components:</p>		
<p>NICHIA</p> <p>LED NV4x144A FWHM / FWTM 11.0° / 24.0° Efficiency 90 % Peak intensity 13.4 cd/lm LEDs/each optic 1 Light colour White Required components:</p>		
<p>NICHIA</p> <p>LED NVSxx19B/NVSxx19C FWHM / FWTM 6.0° / 13.0° Efficiency 93 % Peak intensity 48 cd/lm LEDs/each optic 1 Light colour White Required components:</p>		
<p>NICHIA</p> <p>LED NWSx229A FWHM / FWTM 7.0° / 18.0° Efficiency 91 % Peak intensity 26 cd/lm LEDs/each optic 1 Light colour White Required components:</p>		

OPTICAL RESULTS (MEASURED):

SAMSUNG

LED LH351B
 FWHM / FWTM 5.1° / 13.0°
 Efficiency 90 %
 Peak intensity 51.8 cd/lm
 LEDs/each optic 1
 Light colour White
 Required components:

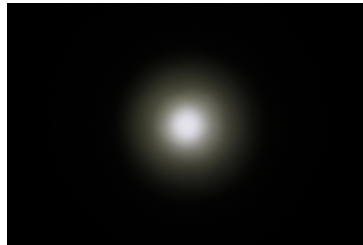



SAMSUNG

LED LH351Z
 FWHM / FWTM 4.2° / 10.0°
 Efficiency 90 %
 Peak intensity 71.4 cd/lm
 LEDs/each optic 1
 Light colour White
 Required components:



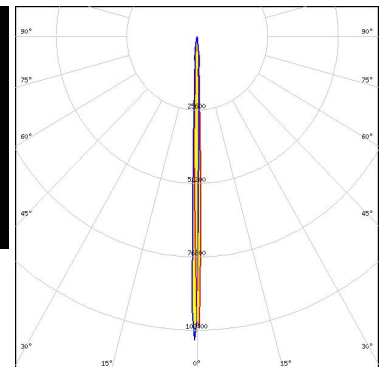





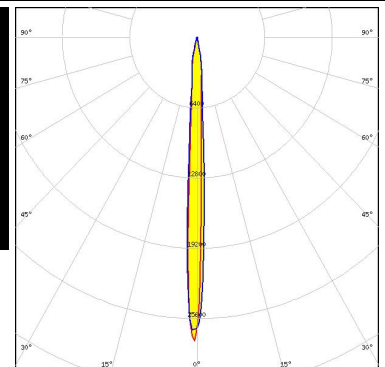
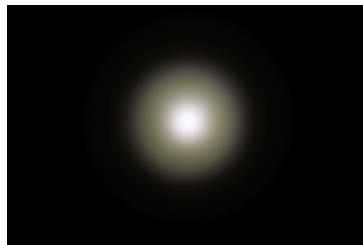

 SEOL SEMICONDUCTOR
 LED nPola
 FWHM / FWTM 2.0° / 7.0°
 Efficiency 94 %
 Peak intensity 114 cd/lm
 LEDs/each optic 1
 Light colour White
 Required components:

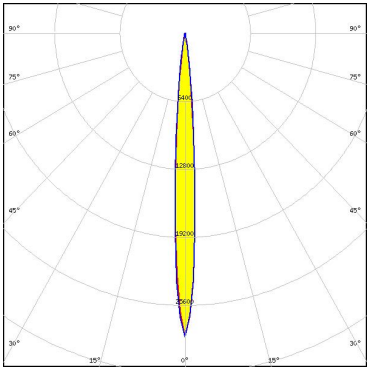

 SEOL SEMICONDUCTOR
 LED Z5M3
 FWHM / FWTM 6.0° / 19.0°
 Efficiency 93 %
 Peak intensity 28.6 cd/lm
 LEDs/each optic 1
 Light colour White
 Required components:

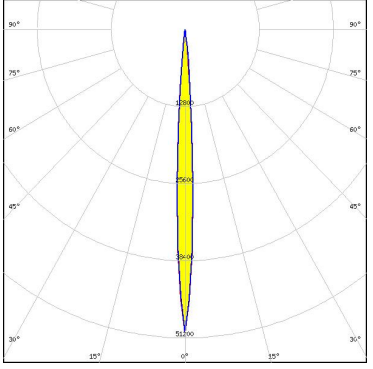

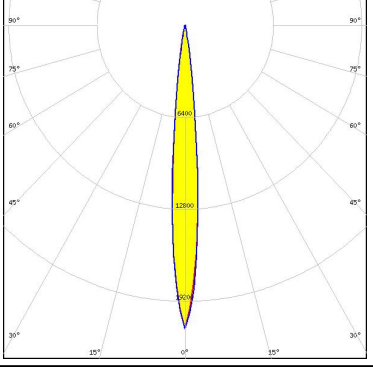
OPTICAL RESULTS (SIMULATED):

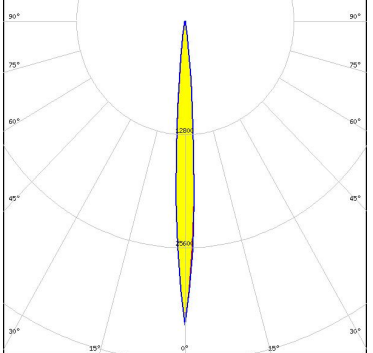
	<p>LED XHP35 HD FWHM / FWTM 7.8° / 17.0° Efficiency 94 % Peak intensity 28.6 cd/lm LEDs/each optic 1 Light colour White Required components:</p>		
	<p>LED XHP35 HI FWHM / FWTM 6.2° / 13.0° Efficiency 94 % Peak intensity 50.4 cd/lm LEDs/each optic 1 Light colour White Required components:</p>		
	<p>LED XHP35.2 HD FWHM / FWTM 10.0° / 19.0° Efficiency 94 % Peak intensity 21.1 cd/lm LEDs/each optic 1 Light colour White Required components:</p>		
	<p>LED XHP35.2 HD FWHM / FWTM 8.0° / 16.0° Efficiency 96 % Peak intensity 34.3 cd/lm LEDs/each optic 1 Light colour White Required components:</p>		

OPTICAL RESULTS (SIMULATED):

CREE LED

LED XHP50.2
 FWHM / FWTM 12.0° / 22.0°
 Efficiency 95 %
 Peak intensity 15.1 cd/lm
 LEDs/each optic 1
 Light colour White
 Required components:

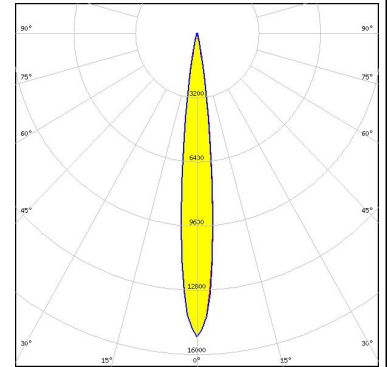

CREE LED

LED XM-L2
 FWHM / FWTM 8.0° / 16.0°
 Efficiency 97 %
 Peak intensity 35 cd/lm
 LEDs/each optic 1
 Light colour White
 Required components:

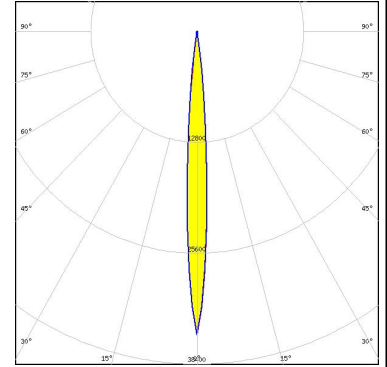

LUMILEDS

LED LUXEON C
 FWHM / FWTM 4.0° / 10.0°
 Efficiency 94 %
 Peak intensity 80.9 cd/lm
 LEDs/each optic 1
 Light colour White
 Required components:

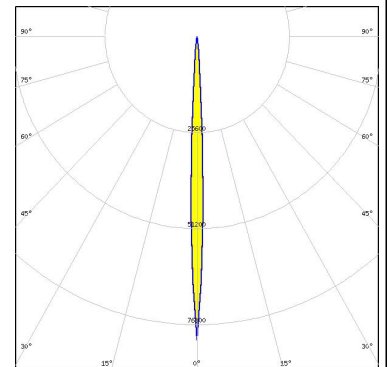

LUMILEDS



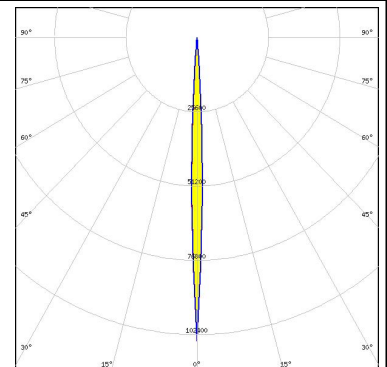





LED LUXEON Rubix
 FWHM / FWTM 4.0° / 10.0°
 Efficiency 95 %
 Peak intensity 104.6 cd/lm
 LEDs/each optic 1
 Light colour Green
 Required components:

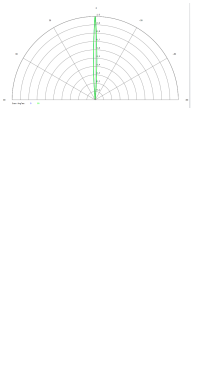

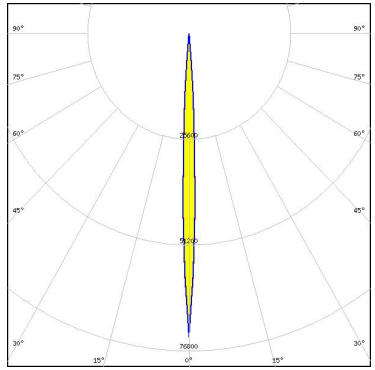
OPTICAL RESULTS (SIMULATED):

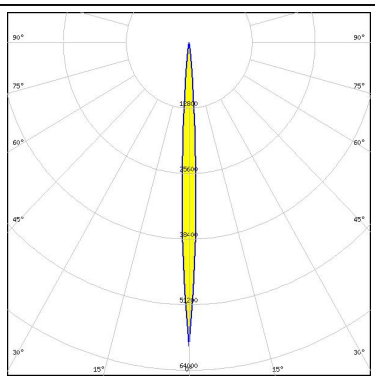
<p>LUMILEDS</p> <p>LED: LUXEON Rubix</p> <p>FWHM / FWTM: 4.0° / 10.0°</p> <p>Efficiency: 95 %</p> <p>Peak intensity: 107.9 cd/lm</p> <p>LEDs/each optic: 1</p> <p>Light colour: Red</p> <p>Required components:</p>	
<p>LUMILEDS</p> <p>LED: LUXEON Rubix</p> <p>FWHM / FWTM: 4.0° / 10.0°</p> <p>Efficiency: 95 %</p> <p>Peak intensity: 96.7 cd/lm</p> <p>LEDs/each optic: 1</p> <p>Light colour: White</p> <p>Required components:</p>	
<p>LUMILEDS</p> <p>LED: LUXEON Rubix</p> <p>FWHM / FWTM: 4.0° / 10.0°</p> <p>Efficiency: 95 %</p> <p>Peak intensity: 104 cd/lm</p> <p>LEDs/each optic: 1</p> <p>Light colour: Blue</p> <p>Required components:</p>	
<p>LUMILEDS</p> <p>LED: LUXEON Rubix</p> <p>FWHM / FWTM: 10.0° / 17.0°</p> <p>Efficiency: 97 %</p> <p>Peak intensity: 26.6 cd/lm</p> <p>LEDs/each optic: 4</p> <p>Light colour: RGBW</p> <p>Required components:</p>	

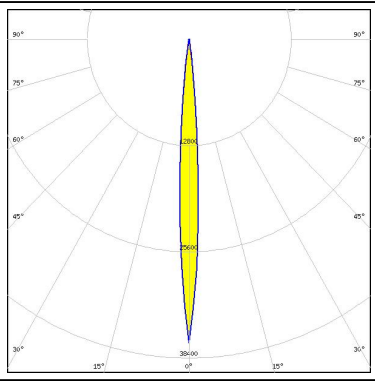
OPTICAL RESULTS (SIMULATED):

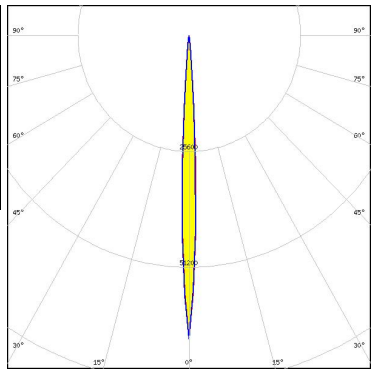
	<p>LED SST-10-B130 FWHM / FWTM 5.0° / 10.0° Efficiency 95 % LEDs/each optic 1 Light colour IR Required components:</p>			
	<p>LED OSCONIQ P 3737 (2W version) FWHM / FWTM 5.5° / 12.8° Efficiency 94 % Peak intensity 59.3 cd/lm LEDs/each optic 1 Light colour White Required components:</p>			
	<p>LED OSCONIQ P 3737 (3W version) FWHM / FWTM 5.5° / 12.8° Efficiency 94 % Peak intensity 59.3 cd/lm LEDs/each optic 1 Light colour White Required components:</p>			
	<p>LED OSLOM Square CSSRM2/CSSRM3 FWHM / FWTM 5.4° / 11.0° Efficiency 94 % Peak intensity 67 cd/lm LEDs/each optic 1 Light colour White Required components:</p>			

OPTICAL RESULTS (SIMULATED):

OSRAM

Opto Semiconductors

LED OSLON Square Flat
 FWHM / FWTM 4.8° / 10.0°
 Efficiency 94 %
 Peak intensity 78 cd/lm
 LEDs/each optic 1
 Light colour White
 Required components:

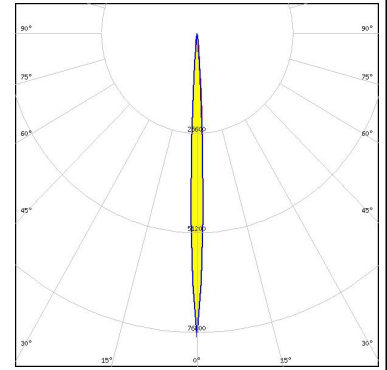

OSRAM

Opto Semiconductors

LED OSTAR Projection Compact (Kx.CSLNM1.xx)
 FWHM / FWTM 4.0° / 8.0°
 Efficiency 94 %
 Peak intensity 122.8 cd/lm
 LEDs/each optic 1
 Light colour White
 Required components:

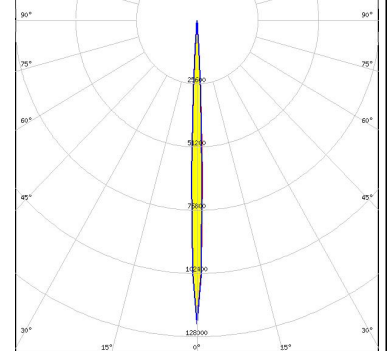

SAMSUNG

LED LH151B
 FWHM / FWTM 10.0° / 20.0°
 Efficiency 97 %
 Peak intensity 19.4 cd/lm
 LEDs/each optic 4
 Light colour White
 Required components:

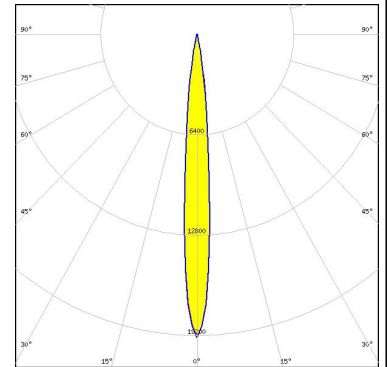

SAMSUNG

LED LH351C
 FWHM / FWTM 6.0° / 14.0°
 Efficiency 96 %
 Peak intensity 44.8 cd/lm
 LEDs/each optic 1
 Light colour White
 Required components:

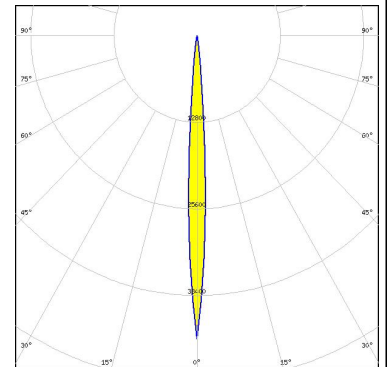

OPTICAL RESULTS (SIMULATED):

SAMSUNG

LED LH351D
 FWHM / FWTM 7.5° / 15.0°
 Efficiency 97 %
 Peak intensity 34.2 cd/lm
 LEDs/each optic 1
 Light colour White
 Required components:

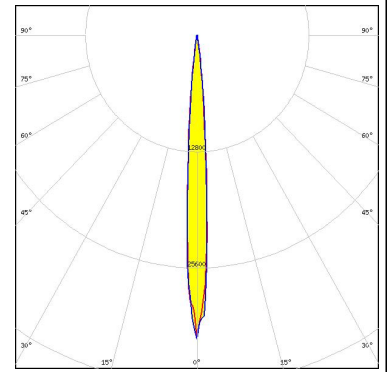

SEOUL SEMICONDUCTOR
 LED Z5M1/Z5M2
 FWHM / FWTM 5.4° / 11.0°
 Efficiency 94 %
 Peak intensity 66.7 cd/lm
 LEDs/each optic 1
 Light colour White
 Required components:

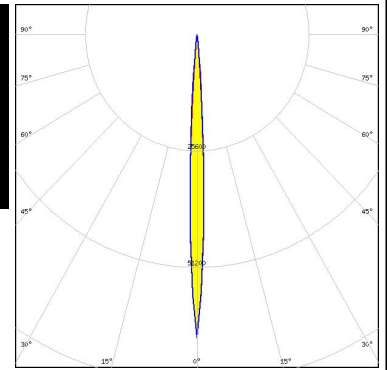
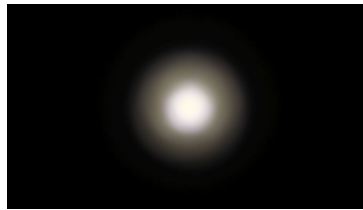

SEOUL SEMICONDUCTOR
 LED Z8Y22P
 FWHM / FWTM 7.8°
 Efficiency 94 %
 Peak intensity 29.9 cd/lm
 LEDs/each optic 1
 Light colour White
 Required components:

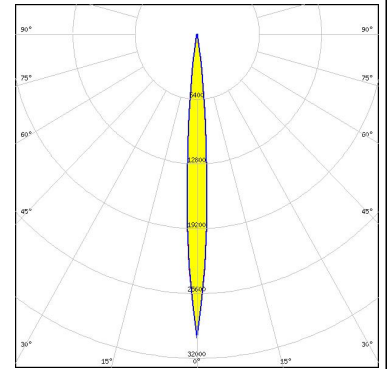

SEOUL SEMICONDUCTOR
 LED Z8Y50P
 FWHM / FWTM 12.0° / 24.0°
 Efficiency 97 %
 Peak intensity 12.7 cd/lm
 LEDs/each optic 1
 Light colour White
 Required components:

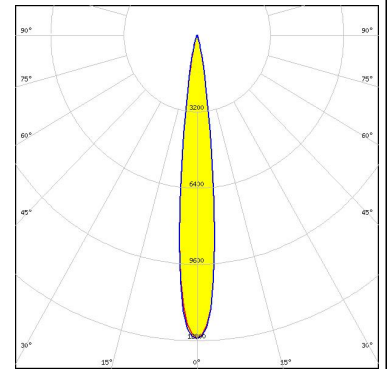

GENERAL INFORMATION:

NOTE: The typical beam angle will be changed by different color, chip size and chip position tolerance. The typical total beam angle is the full angle measured where the luminous intensity is half of the peak value.

MATERIALS:

As part of our continuous research and improvement processes, and to ensure the best possible quality and availability of our products, LEDiL reserves the right to change material grades without notice.

PRODUCT DATA USER AGREEMENT AND DISCLAIMER:

The measured data in the provided downloadable LEDiL Product Datasheets and Mechanical 2D-Drawings is rounded and provided as reference for planning. LEDiL Oy's optical specifications have been verified by conducting performance testing of the products in accordance with the company's quality system. The reported data are averaged results of multiple measurements with typical variation. LEDiL Oy reserves the right to without prior notification make changes and improvements to its products.

LEDiL Oy assumes neither warranty, nor guarantee nor any other liability of any kind for the contents and correctness of the provided data. The provided data has been generated with highest diligence but the provided data may in reality not represent the complete possible variation range of all intrinsic parameters. Therefore, in certain cases a deviation from the provided data could occur.

LEDiL Oy reserves the right to undertake technical changes of its products without further notification which could lead to changes in the provided data. LEDiL Oy assumes no liability of any kind for the possible deviation from any provided data or any other damage resulting from the usage of the provided data.

The user agrees to this disclaimer and user agreement with the download or usage of the provided files.

LEDiL Oy

Joensuunkatu 13
FI-24240 SALO
Finland

LEDiL Inc.

228 West Page Street
Suite D
Sycamore IL 60178
USA

Ledil Optics Technology (Shenzhen) Co., Ltd.

405 , Block B
Casic Motor Building
Shenzhen 518057
P.R.CHINA

Local sales and technical support

[www.ledil.com/
where_to_buy](http://www.ledil.com/where_to_buy)

Shipping locations

Salo, Finland
Hong Kong, China

Distribution Partners

[www.ledil.com/
where_to_buy](http://www.ledil.com/where_to_buy)