

## ANT-433-SPS1 Series Panel Mount 433 MHz Antennas

The ANT-433-SPS1 antenna is an external panel mount puck-style multiband antenna designed for 433 MHz and low-power, wide-area (LPWA) applications, including LoRaWAN®, and remote control applications. The ANT-433-SPS1 also serves as a 410 MHz LTE antenna.

The ANT-433-SPS1 provides a ground plane independent dipole antenna solution which mounts permanently to metallic and non-metallic surfaces.

The antenna terminates in an SMA plug (male pin) connector on 1 meter, 2 meter and 3 meter lengths of RG-174/U coaxial cable enabling an environmentally sealed enclosure and protection from tampering.



### Features

- Performance at 430 MHz to 435 MHz
  - VSWR:  $\leq 1.7$
  - Peak Gain: -1.3 dBi
  - Efficiency: 25%
- Ground plane independent dipole antenna
- External mount, includes all hardware for installation including M12x1 hex nut, washer and optional boot
- SMA plug (male pin) gold plated connection
- IP67 rating
- Impact resistant UV stabilized ABS radome material

### Applications

- Low-power, wide-area (LPWA) applications
  - LoRaWAN®
- Internet of Things (IoT) devices
- Smart Home networking
- Remote sensing, monitoring and control
  - Security systems
  - Garage/gate openers
  - Weather reporting
  - Vending machines
- 410 MHz Cellular LTE

### Ordering Information

Part Number	Description
<b>ANT-433-SPS1-1</b>	1 meter (39.37 in) 433 MHz panel mount antenna with SMA plug (male pin) on RG-174/U coaxial cable and mounting hardware, including M12x1 hex nut, washer and rubber boot
<b>ANT-433-SPS1-2</b>	2 meters (78.74 in) 433 MHz panel mount antenna with SMA plug (male pin) on RG-174/U coaxial cable and mounting hardware, including M12x1 hex nut, washer and rubber boot
<b>ANT-433-SPS1-3</b>	3 meters (118.11 in) 433 MHz panel mount antenna with SMA plug (male pin) on RG-174/U coaxial cable and mounting hardware, including M12x1 hex nut, washer and rubber boot

Available from Linx Technologies and select distributors and representatives.

Table 1. Electrical Specifications

ANT-433-SPS1	410 MHz	433 MHz
Frequency Range	410 MHz to 430 MHz	430 MHz to 435 MHz
VSWR (max.)	2.3	1.7
Peak Gain (dBi)	-0.1	-1.3
Average Gain (dBi)	-5.2	-6.2
Efficiency (%)	32	25
Polarization	Linear	
Radiation	Omnidirectional	
Max Power	15 W	
Wavelength	1/2-wave	
Electrical Type	Dipole	
Impedance	50 Ω	

Electrical specifications and plots measured with a 300 mm x 300 mm (11.8 in x 11.8 in) ground plane.

Table 2. Mechanical Specifications

ANT-433-SPS1	
Connection	SMA plug (male pin)
Cable	1 meter (39.37 in), 2 meters (78.74 in) and 3 meters (118.11 in) of RG-174/U coaxial cable
Weight	63.4 g (2.24 oz)
Dimensions	23.3 mm x Ø54.7 mm (0.92 in x Ø2.15 in)
IP Rating	IP67
Operating Temp. Range	-40 °C to +70 °C

Product Dimensions

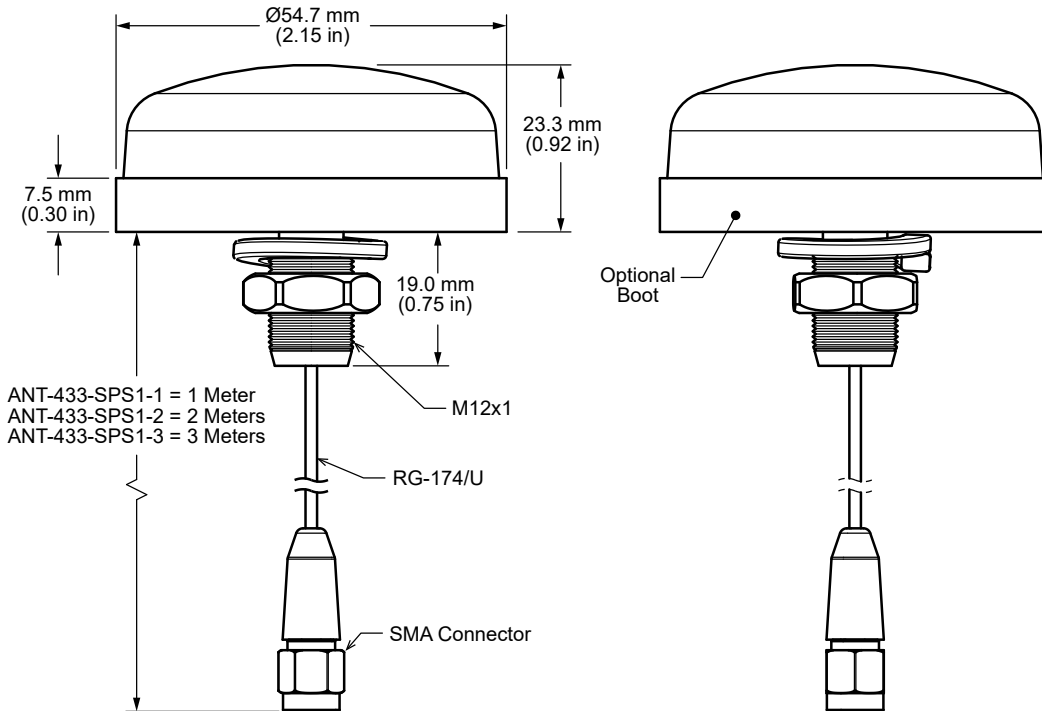

Figure 1. ANT-433-SPS1 Dimensions

VSWR

Figure 2 provides the voltage standing wave ratio (VSWR) across the antenna bandwidth. VSWR describes the power reflected from the antenna back to the radio. A lower VSWR value indicates better antenna performance at a given frequency. Reflected power is also shown on the right-side vertical axis as a gauge of the percentage of transmitter power reflected back from the antenna.

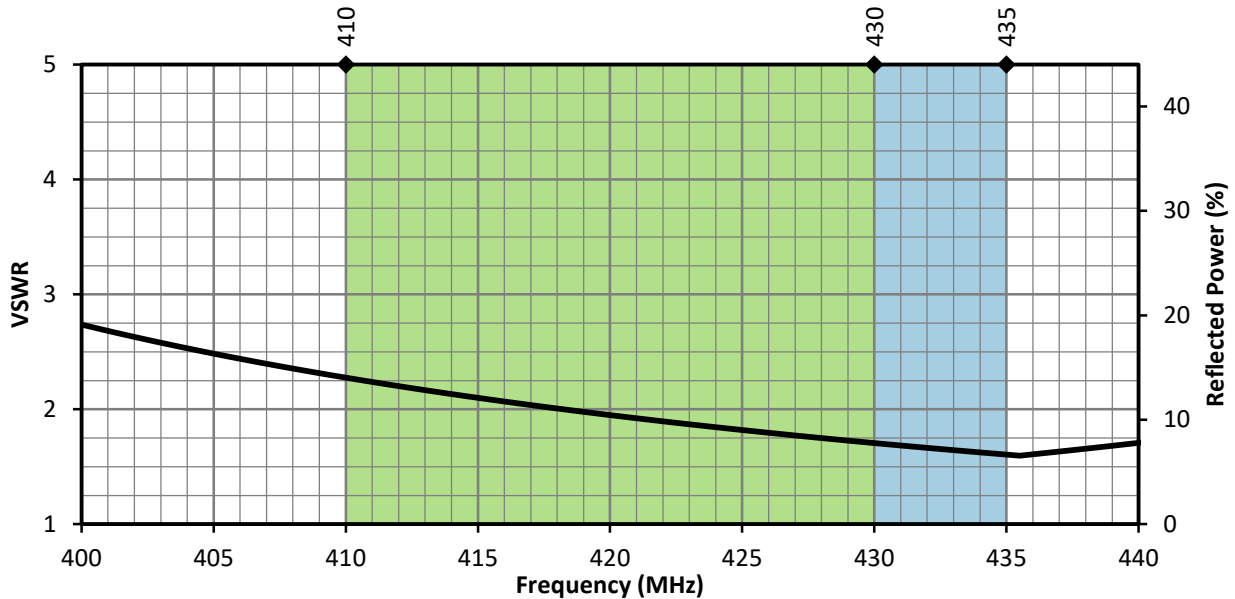

Figure 2. ANT-433-SPS1 Antenna VSWR with Frequency Band Highlights

Return Loss

Return loss (Figure 3), represents the loss in power at the antenna due to reflected signals. Like VSWR, a lower return loss value indicates better antenna performance at a given frequency.

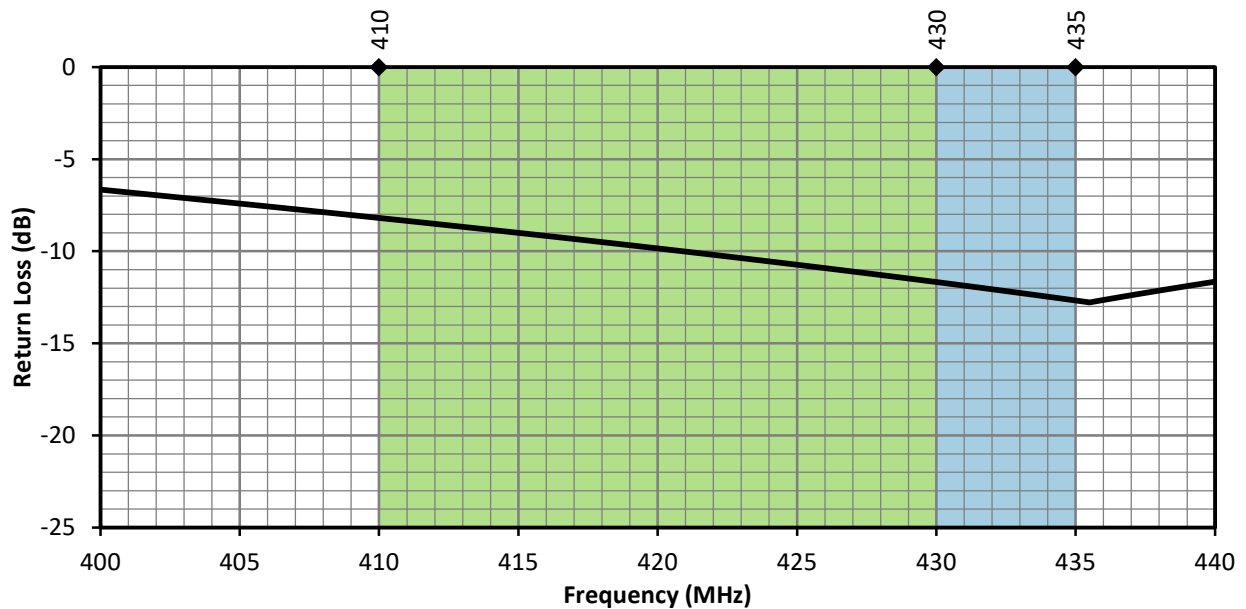

Figure 3. ANT-433-SPS1 Antenna Return Loss with Frequency Band Highlights

### Peak Gain

The peak gain across the antenna bandwidth is shown in Figure 4. Peak gain represents the maximum antenna input power concentration across 3-dimensional space, and therefore peak performance, at a given frequency, but does not consider any directionality in the gain pattern.

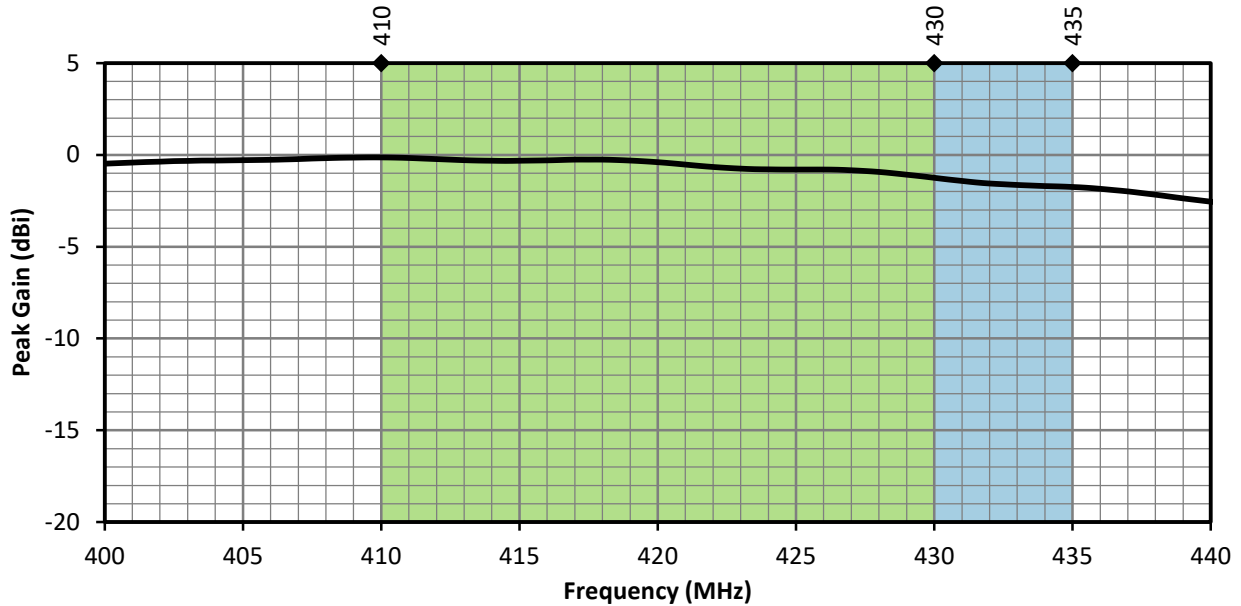

Figure 4. ANT-433-SPS1 Antenna Peak Gain with Frequency Band Highlights

### Average Gain

Average gain (Figure 5), is the average of all antenna gain in 3-dimensional space at each frequency, providing an indication of overall performance without expressing antenna directionality.

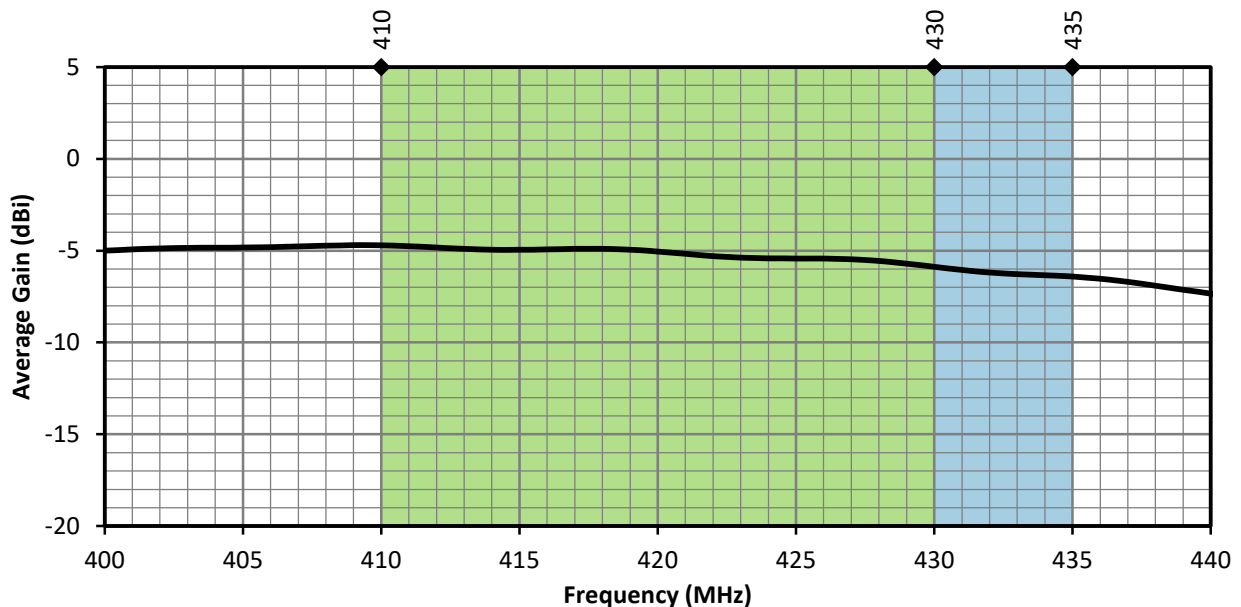

Figure 5. ANT-433-SPS1 Antenna Average Gain with Frequency Band Highlights

### Radiation Efficiency

Radiation efficiency (Figure 6), shows the ratio of power delivered to the antenna relative to the power radiated at the antenna, expressed as a percentage, where a higher percentage indicates better performance at a given frequency.

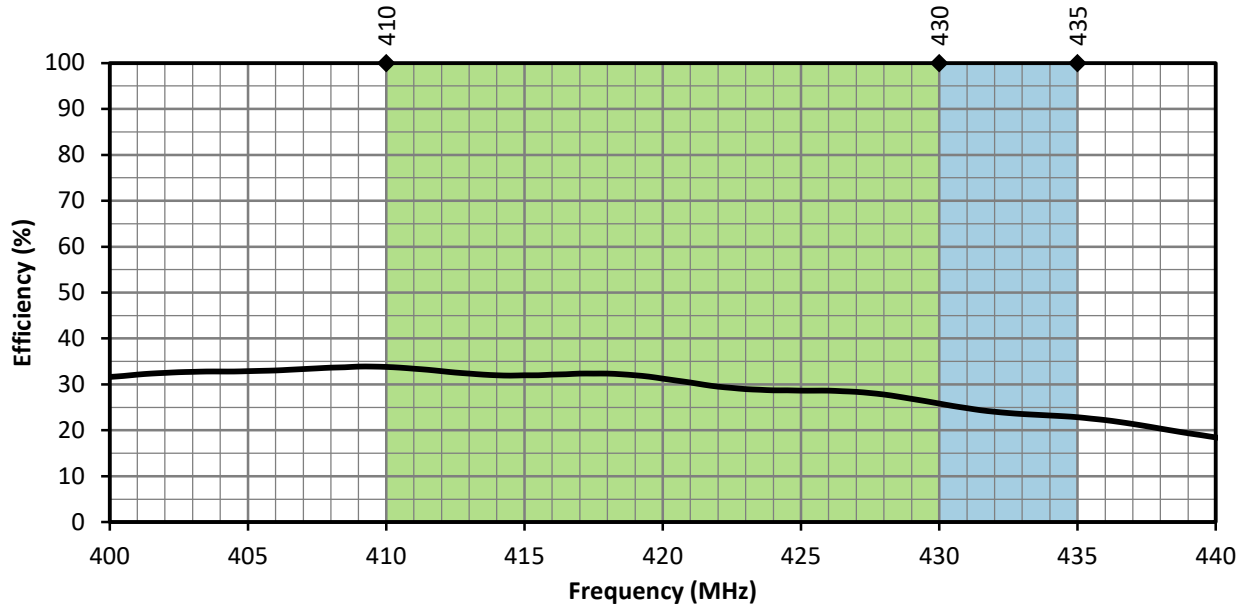

Figure 6. ANT-433-SPS1 Antenna Radiation Efficiency with Frequency Band Highlights

Radiation Patterns

Radiation patterns provide information about the directionality and 3-dimensional gain performance of the antenna by plotting gain at specific frequencies in three orthogonal planes. Antenna radiation patterns (Figure 7), are shown using polar plots covering 360 degrees. The antenna graphic above the plots provides reference to the plane of the column of plots below it. Note: when viewed with typical PDF viewing software, zooming into radiation patterns is possible to reveal fine detail.



410 MHz to 430 MHz (420 MHz)

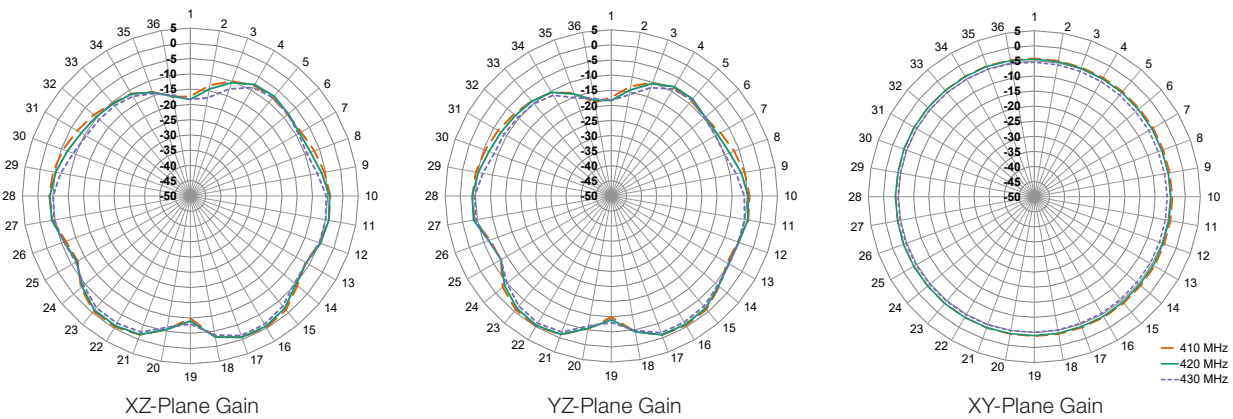

430 MHz to 435 MHz (433 MHz)

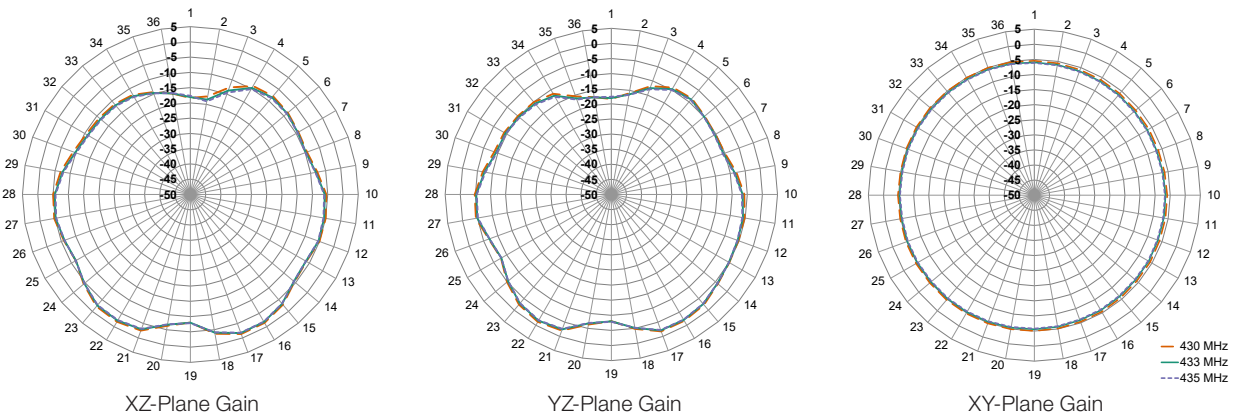
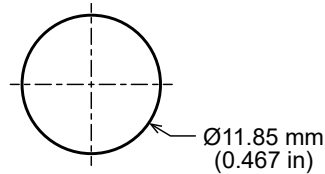

Figure 7. Radiation Patterns for ANT-433-SPS1 Antenna

**Antenna Mounting**

The ANT-433-SPS1 antenna is an externally mounted multiband antenna that can be permanently installed onto metallic and non-metallic surfaces up to 3.9 mm (0.15 in) thick when used with the provided boot, and up to 4.2 mm (0.17 in) without the boot. Use of the boot is optional, and is intended to reduce the potential for marring of the mounting surface.

The antenna terminates in a M12x1 threaded shaft and is provided with a washer and hex nut. The mounting hole dimensions are shown in Figure 8.



**Figure 8. ANT-433-SPS1 Mounting Hole Dimensions**

**Packaging Information**

The ANT-433-SPS1 series antenna is individually placed in a polyethylene bag. 50 pcs. are sealed in larger polyethylene bags. Larger quantities are shipped in cartons of 100 pcs. Carton size = 320 mm x 250 mm x 230 mm (12.60 in x 9.84 in x 9.10 in). Distribution channels may offer alternative packaging options..

---

**Website:** <http://linxtechnologies.com>  
**Linx Offices:** 159 Ort Lane, Merlin, OR, US 97532  
**Phone:** +1 (541) 471-6256  
**E-MAIL:** [info@linxtechnologies.com](mailto:info@linxtechnologies.com)

---

Linx Technologies reserves the right to make changes to the product(s) or information contained herein without notice. No liability is assumed as a result of their use or application. No rights under any patent accompany the sale of any such product(s) or information.

Wireless Made Simple is a registered trademark of Linx Acquisitions LLC. LoRaWAN is a registered trademark of Semtech Corporation. Sigfox is a registered trademark of SIGFOX. Other product and brand names may be trademarks or registered trademarks of their respective owners.

Copyright © 2021 Linx Technologies

All Rights Reserved

Doc# DS21033-148ANT

