

Modbus on Senseair Sunrise and Sunlight

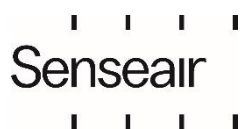
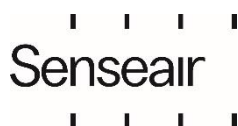

Table of contents:

1.	Modbus protocol.....	3
1.1.	Serial line frame and addressing	3
1.2.	Bus timing.....	4
1.3.	Function code descriptions (PUBLIC).....	4
1.4.	References	10
2.	Modbus on Senseair Sunrise and Sunlight	11
2.1.	Modbus settings.....	11
2.2.	Modbus registers.....	11
2.1.	Input Registers (IR).....	12
2.2.	Holding Registers (HR).....	15
3.	Examples	20
3.1.	Read Error Status and gas concentration	20
3.2.	Set measurement mode to single measurement mode	20
3.3.	Communication sequence for single measurement mode.....	21
3.1.	Sensor state data exist	22
3.2.	State data does not exist, or it is an initial measurement	23
3.4.	Enable/Disable ABC	25
3.5.	Enable/Disable dynamic IIR filter	27
3.6.	Background Calibration	29
	Continuous measurement mode	29
	Single measurement mode	29
3.7.	Target Calibration.....	30
3.8.	Set Modbus address	31
3.9.	Pressure compensation	31
3.10.	Write pressure to sensor	32
4.	Revision history	33



1. Modbus protocol

Modbus is a simple, open protocol for both PLC and sensors [1][2]. Details on Modbus can be found on the website www.modbus.org.

1.1. Serial line frame and addressing

Serial line frame

Modbus over serial line specification [2] distinguishes Modbus Protocol PDU and Modbus serial line PDU in the following way:

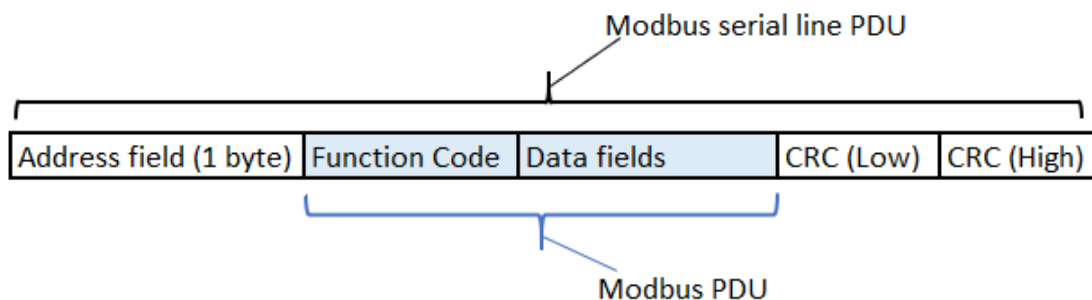

Addressing rules

The addressing rules are summarised in the table:

Address	Modbus over serial line V1.0	Senseair Sunrise and Sunlight
0 (0x00)	Broadcast address	No broadcast commands currently implemented
1 to 247 (0x01 to 0xF7)	Slave individual address	Slave individual address
248 to 253 (0xF8 to 0xFD)	Reserved	Nothing ¹⁾
254 (0xFE)	Reserved	“Any sensor” ²⁾
255 (0xFF)	Reserved	Nothing ¹⁾

Notes:

- 1) “Nothing” means that the sensor doesn’t recognise Modbus serial line PDUs with this address as addressed to the sensor. The sensor does not respond.
- 2) “Any sensor” means that any sensor with any slave individual address will recognise serial line PDUs with address 254 as addressed to them. They will respond. This address is for production / test purposes only and must not be used in the installed network. This is a violation against the Modbus specification [1].



1.2. Bus timing

Parameter	Min	Typ	Max	Units
Response time-out			180	ms

“Response time-out” is defined to prevent the master (host system) from staying in “Waiting for reply” state indefinitely. Refer to page 9 of MODBUS over serial line specification [2].

For slave device “Response time-out” represents maximum time allowed to take by “processing of required action”, “formatting normal reply” and “normal reply sent” alternatively by “formatting error reply” and “error reply sent”, refer to the slave state diagram on page 10 of the document mentioned above.

1.3. Function code descriptions (PUBLIC)

Description of exception responses

If the PDU of the received command has wrong format:

No Response PDU, sensor doesn't respond

If Function Code isn't equal to any implemented function code:

Exception Response PDU

Function code	1 byte	Function Code + 0x80
Exception code = <i>Illegal Function</i>	1 byte	0x01

If one or more of addressed Registers is not assigned (register is reserved or Quantity of registers is larger than maximum number of supported registers):

Exception Response PDU

Function code	1 byte	Function Code + 0x80
Exception code = <i>Illegal Data Address</i>	1 byte	0x02

01 (0x01) Read Coils

One bit read/write registers.

Not implemented.

02 (0x02) Read Discrete Input

One bit read only registers.

Not implemented.

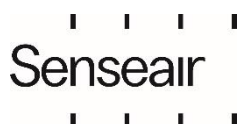

03 (0x03) Read Holding Registers

16 bits read/write registers.

Refer to Modbus specification [1].

Request PDU

Function code	1 byte	0x03
Starting Address Hi	1 byte	Address Hi
Starting Address Lo	1 byte	Address Lo
Quantity of Registers Hi	1 byte	Quantity Hi
Quantity of Registers Lo	1 byte	Quantity Lo

Response PDU

Function code	1 byte	0x03
Byte Count	1 byte	2 x N*
Register Value	N* x 2 bytes	

* N = Quantity of Registers

If Address is out of range:

Exception Response PDU

Function code	1 byte	0x83
Exception code = <i>Illegal Data Address</i>	1 byte	0x02

If Quantity=0 or Quantity>Number of Registers:

Exception Response PDU

Function code	1 byte	0x83
Exception code = <i>Illegal Data Value</i>	1 byte	0x03

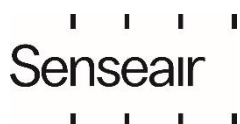

04 (0x04) Read Input Registers

16 bits read only registers.

Refer to Modbus specification [1].

Quantity of Registers is limited to 32.

Request PDU

Function code	1 byte	0x04
Starting Address Hi	1 byte	Address Hi
Starting Address Lo	1 byte	Address Lo
Quantity of Registers Hi	1 byte	Quantity Hi
Quantity of Registers Lo	1 byte	Quantity Lo

Response PDU

Function code	1 byte	0x04
Byte Count	1 byte	2 x N*
Register Value	N* x 2 bytes	

* N = Quantity of Registers

If Address is out of range:

Exception Response PDU

Function code	1 byte	0x84
Exception code = <i>Illegal Data Address</i>	1 byte	0x02

If Quantity=0 or Quantity>Number of registers:

Exception Response PDU

Function code	1 byte	0x84
Exception code = <i>Illegal Data Value</i>	1 byte	0x03

05 (0x05) Write Single Coil

One bit read/write register.

Not implemented.

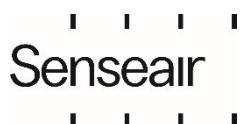

06 (0x06) Write Single Register

16 bits read / write register.

Not implemented.

15 (0x0F) Write Multiple Coils

One bit read / write registers.

Not implemented.

16 (0x10) Write Multiple Registers

16 bits read/write register.

Refer to Modbus specification [1].

Address of Modbus Holding Registers for 1-command reading/writing is limited in range 0x0000..0x002F.

Request PDU

Function code	1 byte	0x10
Starting Address Hi	1 byte	Address Hi
Starting Address Lo	1 byte	Address Lo
Number of Register Hi	1 byte	Value Hi
Number of Register Lo	1 byte	Value Lo
The Number of Data Bytes	1 byte	2 x N*
Register Value to Write	2 x N* bytes	Value to write

* N = Quantity of Registers

Response PDU (is an echo of the Request)

Function code	1 byte	0x10
Starting Address Hi	1 byte	Address Hi
Starting Address Lo	1 byte	Address Lo
Number of Register written Hi	1 byte	Value Hi
Number of Register written Lo	1 byte	Value Lo

If Address is out of range:

Exception Response PDU

Function code	1 byte	0x90
Exception code = <i>Illegal Data Address</i>	1 byte	0x02

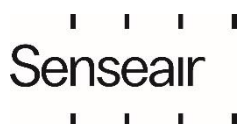

20 (0x14) Read File record

Not implemented.

21 (0x15) Write File record

Not implemented.

22 (0x16) Mask Write Register

16 bits read/write register.

Not implemented.

23 (0x17) Read / Write Multiple Registers

16 bits read/write register.

Not implemented.

43 / 14 (0x2B / 0x0E) Read Device Identification

Refer to Modbus specification ...

The sensor only supports Read Device ID code 4, individual access.

Objects 0x00 ..0x02 (basic identification) are available (see table)

Object ID	Object Name / Description	Type	Modbus status	Category	Implementation status
0x00	Vendor Name	ASCII string*	Mandatory	Basic	Implemented
0x01	ProductCode	ASCII string*	Mandatory	Basic	Implemented
0x02	MajorMinorRevision	ASCII string*	Mandatory	Basic	Implemented
0x03	VendorUrl	ASCII string*	Optional	Regular	Not Implemented
0x04	ProductName	ASCII string*	Optional	Regular	Not Implemented
0x05	ModelName	ASCII string*	Optional	Regular	Not Implemented
0x06	UserApplicationName	ASCII string*	Optional	Regular	Not Implemented
0x07.. 0x7F	Reserved				
0x80	Memory map version	1 byte unsigned	Optional	Extended	Not Implemented
0x81	Firmware revision, consists of: Firmware type, Revision Main, Revision Sub	3 bytes unsigned	Optional	Extended	Not Implemented
0x82	Sensor serial number (sensor ID)	4 bytes unsigned	Optional	Extended	Not Implemented
0x83	Sensor type	3 bytes unsigned	Optional	Extended	Not Implemented

■ ■ ■ ■
Senseair

■ ■ ■ ■

*The ASCII strings are different for different models. As an example:

Vendor Name = "Senseair" (length 8 bytes)

Product Code = "Sunrise" / "Sunlight" (length 7/8 bytes)

MajorMinorRevision = "1.00" (length 4 bytes)

Example: Read objects of category "Basic"

Request PDU, Object ID 0x00 to 0x02

Function code	1 byte	0x2B
MEI Type	1 byte	0x0E
Read Device ID code	1 byte	0x04 (individual access only)
Object ID	1 byte	0x00..0x02

Response PDU, Object ID 0x00 to 0x02

Function code	1 byte	0x2B
MEI Type	1 byte	0x0E
Read Device ID code	1 byte	0x04, same as in request
Conformity level	1 byte	0x81, basic identification for individual or stream access
More Follows	1 byte	0x00
Next Object ID	1 byte	0x00
Number of objects	1 byte	0x01
Object ID	1 byte	0x00..0x02
Object length	1 byte	0x0B or 0x07 or 0x04 (see definition of ASCII strings)
Object value	n byte	Object Data

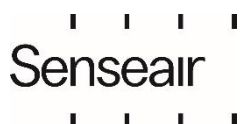

If wrong MEI Type:

Exception Response PDU

Function code	1 byte	0xAB
Exception code = <i>Illegal Function Code</i>	1 byte	0x01

If Object ID is not in range 0x00..0x03:

Exception Response PDU

Function code	1 byte	0xAB
Exception code = <i>Illegal Data Address</i>	1 byte	0x02

If wrong Device ID:

Exception Response PDU

Function code	1 byte	0xAB
Exception code = <i>Illegal Data Value</i>	1 byte	0x03

Note: The exception response for function code 43 is implemented according to the RFC “RFC Non extended Exception code format of 43 Encapsulated Transport.doc” which is in status “Recommended for approval” at time of writing. This is in contrast with the Modbus specification [1] where the exception responses for function code 43 also have a MEI type field.

23 (0x17) Read / Write Multiple Registers

16 bits read/write register.

Not implemented.

1.4. References

- [1] MODBUS Application Protocol Specification V1.1b
- [2] MODBUS over serial line specification and implementation guide V1.02
- [3] TDE7318, Sunrise user guideline

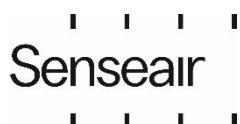

2. Modbus on Senseair Sunrise and Sunlight

2.1. Modbus settings

Senseair Sunrise and Sunlight supports 9600 baud rate only.

Other Modbus settings are as follows:

Setting	Value
Default slave address	104 (0x68)
Baud rate	9600 bps
Parity	None
DataBits	8
StopBits	1

2.2. Modbus registers

The Modbus registers are mapped in memory and the mapping is interpreted by the sensor at command reception.

The register maps are summarised in Table 1 and Table 2. All registers are 16-bit words. The associated number is the Modbus register number. The register address is calculated as (register number -1). For example, the address of IR4 is 3.

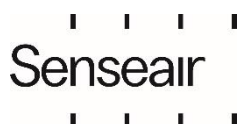

2.1. Input Registers (IR)

IR#	Addr	Name	Description (read only registers)		
IR1	0x00	ErrorStatus			
			Bit	Error description	Suggested action
			0	Fatal error Indicates that initialisation of analog front end failed	Try to restart sensor by power on/off. Contact local distributor.
			1	Communication error Attempt to read or write to not exiting addresses/registers detected.	Try to restart sensor by power on/off. Check wires, connectors and communication protocol implementation. Contact local distributor.
			2	Algorithm error Corrupt parameters detected.	Try to restart sensor by power on/off. Contact local distributor.
			3	Calibration error Indicates that calibration has failed (ABC, zero, background or target calibration).	Try to repeat calibration. Ensure that the environment is stable during calibration.
			4	Self-diagnostics error Indicates internal failure. For articles 006-0-0008: Detailed information of the failure can be found in bit 9-10.	Try to restart sensor by power on/off. Contact local distributor.
			5	Out of range Indicates that the measured concentration, temperature, or set pressure are outside the sensor's measurement range	Ensure that the environment is within the sensors operating range (see Product specification) If pressure compensation is enabled, provide valid pressure value for pressure compensation. Perform suitable gas calibration (zero, background or target calibration). Contact local distributor.
			6	Memory error Error during memory operations	Try to restart sensor by power on/off. Contact local distributor.

Senseair

■ ■ ■ ■

			7	<p>No measurement completed</p> <p>Bit set at startup, cleared after first measurement</p>	<p>0 – First measurement cycle completed</p> <p>1 – No measurement completed</p> <p>If sensor is used in single measurement mode and powered down between measurements, this bit can be used to verify started measurement cycle has finished</p>
			8	<p>Low internal regulated voltage</p> <p>For article 006-0-0007: Flag is set if sensor's internal regulated voltage is too low, this means supply voltage is lower than 2.8V. Flag is cleared after internal voltage normalization.</p> <p>For article 006-0-0008: Flag is set if sensor's internal regulated voltage dropped below 2.8V and sensor's reset occurred. Flag shall be cleared by proper power-off/on sequence, reset command or by writing into "Clear ErrorStatus" register.</p>	<p>Check power supply.</p> <p>This means output voltage from internal regulator is lower than 2.8V or due too low input sensor's voltage or due internal regulator malfunction. Measurement data is not valid.</p>
			9	<p>Measurement timeout</p> <p>Flag is set if sensor is unable to complete the measurement in time.</p> <p>For article 006-0-0008: This flag is set in combination with the Self-diagnostic flag.</p>	<p>Flag is cleared after a successful measurement.</p> <p>If flag is set permanently, try to restart sensor by power on/off.</p> <p>Contact local distributor.</p>
			10	<p>For article 006-0-0008: Abnormal signal level</p> <p>Flag is set if an invalid measurement sample is detected.</p> <p>This flag is set in combination with the Self-diagnostic flag.</p>	<p>Flag is cleared after a successful measurement.</p> <p>If flag is set permanently, try to restart sensor by power on/off.</p> <p>Contact local distributor.</p>
			11	Reserved	
			12	Reserved	
			13	Reserved	

			14	Reserved	
			15	Reserved	
IR2	0x01	Reserved			
IR3	0x02	Reserved			
IR4	0x03	Measured concentration Filtered Pressure Compensated	Filtered pressure compensated gas concentration. Signed 16 bit value, unit ppm. IR4 is equal to IR10 if pressure compensation is disabled at HR19 (default) See [3] for details about IIR filtration and pressure compensation.		
IR5	0x04	Temperature	Chip temperature. Signed 16 bit value, unit °C x100. For example, register value = 2223 means 22.23°C.		
IR6	0x05	Reserved			
IR7	0x06	Measurement count	Counter incremented after each measurement, range 0 – 255. Counter value can for example be used by the host system to ensure that the sensor has done a measurement since last time measured concentration was read.		
IR8	0x07	Measurement cycle time	Measurement cycle time shows current time in present measurement cycle, incremented every 2 seconds. For example, IR8 = 3 it means 6 seconds has passed in current measurement cycle. The value is set to 0 when sensor starts a new measurement. This value can be used by the host system to synchronise readings with sensor measurements.		
IR9	0x08	Measured concentration Unfiltered Pressure Compensated	Unfiltered pressure compensated gas concentration. Signed 16 bit value, unit ppm. IR9 is equal to IR11 if pressure compensation is disabled at HR19 (default)		
IR10	0x09	Measured concentration Filtered	Filtered gas concentration. Signed 16 bit value, unit ppm. See [3] for details about IIR filtration.		
IR11	0x0A	Measured concentration Unfiltered	Unfiltered gas concentration. Signed 16 bit value, unit ppm.		
...		Reserved			
IR24	0x17	FW type	Firmware type. Unsigned 16 bit value.		
...		Reserved			
IR29	0x1C	FW rev.	Firmware revision. Unsigned 16 bit value. (bit 15 - 8 main) & (bit 7 - 0 sub)		
IR30	0x1D	Sensor Id (bit31 – bit16)	Sensor Id. Unsigned 32 bit value.		
IR31	0x1E	Sensor Id (bit15 – bit0)			
IR32		Reserved			

Table 1. Input Registers (IR)

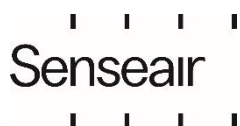

2.2. Holding Registers (HR)

HR#	Addr	Name	Description (read/write registers)	
HR1	0x00	Calibration Status	These bits are set after successful calibrations. The bits need to be cleared/reset by host system; it is recommended to do this before triggering a calibration using the HR2 register.	
			Bit	Description
			0	
			1	
			2	Factory calibration restored
			3	ABC calibration
			4	Target calibration
			5	Background calibration
			6	Zero calibration
HR2	0x01	Calibration Command	Calibration is initiated by the commands in the table below. See [3] for description of the different calibration modes.	
			The sensor will perform a calibration based on the first measurement immediately after the calibration command was received. Host system should trig a measurement after writing the calibration command in single measurement mode. After having performed the calibration, all following measurements will use the adjusted calibration parameters.	
			It is recommended that HR1 is cleared before initiating a calibration.	
			Command	Name and description
			0x7C02	Restore factory calibration. Restores calibration parameters to factory calibration values.
			0x7C03	Forced ABC calibration. Sensor will perform an ABC calibration after receiving this command if sensor has valid ABC data. The command can be used if one for some reason wants to do an ABC adjustment before one ABC period has passed (when a normal ABC calibration is done). This command only works if ABC is enabled, see HR14 & HR19.
			0x7C05	Target calibration. Calibration using HR3 value as calibration target.
0x7C06	Background calibration Calibration using ABC target as calibration target.			
0x7C07	Zero calibration. Calibration using 0 ppm gas as calibration target.			

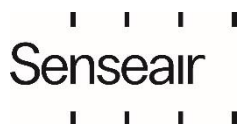

HR3	0x02	Calibration Target	Calibration target used by target calibration (HR2 - 0x7C05 command). Unit ppm.
HR4	0x03	Measured concentration Override	Default value = 32767 (no override). If a value lower than default is written to the register, both the gas filtered and unfiltered registers will be set to this value.
HR5	0x04	ABC Time	Time passed since last ABC calibration in hours. If ABC is enabled when sensor is used in single measurement mode and powered down between measurements, the host system must read this register from the sensor after each measurement, increment its value every hour and write back to the sensor after each power on (enable) before a new measurement is triggered.
HR6	0x05	ABC Par0	If ABC is enabled when sensor is used in single measurement mode and powered down between measurements, these registers must be read from the sensor after each measurement and written back to the sensor after each power on (enable) before a new measurement is triggered.
HR7	0x06	ABC Par1	
HR8	0x07	ABC Par2	
HR9	0x08	ABC Par3	
HR10	0x09	Start Single Measurement	Writing 1 to this register initiates a measurement if the sensor is configured for single measurement mode.
HR11	0x0A	Measurement Mode (EE)	There are two measurement modes to choose between. Register value = 0, continuous mode (default) Register value = 1, single measurement mode. A system reset is required after changing measurement mode.
HR12	0x0B	Measurement Period (EE)	Measurement period in seconds (range from 2 to 65534). Odd numbers will be rounded up to nearest even number. A system reset is required after changing configuration. Default value is 16. Note: Measurement period is only used in continuous measurement mode
HR13	0x0C	Number of samples (EE)	Number of samples in one measurement (range from 1 to 1024). A higher number leads to a better accuracy but also a higher power consumption. A system reset is required after changing configuration. Default is 8 samples. One sample takes max 300ms, this means that (Number of samples * 0.3s) should be less than or equal to time between measurements. If time for executing all samples in a measurement is longer than measurement period, sensor will execute all samples and after that start a new measurement. This means that actual measurement period will be longer than measurement period specified in HR12. Note (not applicable for 006-0-0007): Odd numbers will be internally rounded down to nearest even number and values below 2 will be replaced with 2.

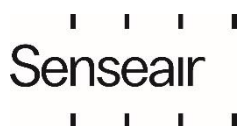

HR14	0x0D	ABC period (EE)	Period for ABC cycle in hours (range from 1 to 65534). Default is 180 hours. ABC enabled by writing 1 to 65534 at HR14 and bit 1 = 0 at HR19. ABC disabled by writing 0 or 65535 to HR14 or bit 1 = 1 at HR19.																		
HR15	0x0E	Clear ErrorStatus	Write any number to this register to clear ErrorStatus																		
HR16	0x0F	ABC Target (EE)	Target value for background and ABC calibrations (ppm gas).																		
HR17	0x10	Static IIR filter parameter	Parameter for static IIR filter, range from 2 – 10. A higher value corresponds to a harder filtration. See [3] for details about IIR filtration.																		
HR18	0x11	SCR	The SCR register is used to reset the sensor Register value = 0xFF, sensor will reset/restart itself.																		
HR19	0x12	Meter control (EE)	Bit field used to enable/disable sensor functions																		
			<table border="1"> <thead> <tr> <th>Bit</th> <th>Description</th> </tr> </thead> <tbody> <tr> <td>0</td> <td>0 - nRDY enabled (default) 1 - nRDY disabled</td> </tr> <tr> <td>1</td> <td>0 - ABC enabled (default) 1 - ABC disabled</td> </tr> <tr> <td>2</td> <td>0 – Static IIR filter enabled (default) 1 - Static IIR filter disabled</td> </tr> <tr> <td>3</td> <td>0 – Dynamic IIR filter enabled (default) 1 – Dynamic IIR filter disabled To enable dynamic IIR filter both static IIR filter (bit2) and dynamic IIR filter (bit3) has to be enabled</td> </tr> <tr> <td>4</td> <td>0 – Pressure compensation enabled 1 – Pressure compensation disabled (default)</td> </tr> <tr> <td>5</td> <td>0 – nRDY pin invert enabled, low during measurement 1 – nRDY pin invert disabled (default), high during measurement</td> </tr> <tr> <td>6</td> <td></td> </tr> <tr> <td>7</td> <td></td> </tr> </tbody> </table>	Bit	Description	0	0 - nRDY enabled (default) 1 - nRDY disabled	1	0 - ABC enabled (default) 1 - ABC disabled	2	0 – Static IIR filter enabled (default) 1 - Static IIR filter disabled	3	0 – Dynamic IIR filter enabled (default) 1 – Dynamic IIR filter disabled To enable dynamic IIR filter both static IIR filter (bit2) and dynamic IIR filter (bit3) has to be enabled	4	0 – Pressure compensation enabled 1 – Pressure compensation disabled (default)	5	0 – nRDY pin invert enabled, low during measurement 1 – nRDY pin invert disabled (default), high during measurement	6		7	
			Bit	Description																	
			0	0 - nRDY enabled (default) 1 - nRDY disabled																	
			1	0 - ABC enabled (default) 1 - ABC disabled																	
			2	0 – Static IIR filter enabled (default) 1 - Static IIR filter disabled																	
			3	0 – Dynamic IIR filter enabled (default) 1 – Dynamic IIR filter disabled To enable dynamic IIR filter both static IIR filter (bit2) and dynamic IIR filter (bit3) has to be enabled																	
			4	0 – Pressure compensation enabled 1 – Pressure compensation disabled (default)																	
			5	0 – nRDY pin invert enabled, low during measurement 1 – nRDY pin invert disabled (default), high during measurement																	
			6																		
7																					
EEPROM mapped register																					
HR20	0x13	MB/I2C address (EE)	Modbus address, range 1 – 247 (0x01 – 0xF7). Default value is 104 (0x68). A sensor reset is needed to activate the new address. EEPROM mapped register																		
...		Reserved																			

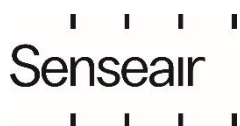

Registers from HR33 – HR39 are mirrors of registers HR1, HR10 and HR5-HR9. The reason for this is to make it possible to only write respective read one block of read/write registers when sensor is used in single measurement mode and powered down between measurements. See example 3.3 for details

HR33	0x20	Calibration Status	These bits are set after successful calibrations. The sensor never resets the bits so if the host system uses these bits it also must reset them.	
			Bit	Description
			0	
			1	
			2	Factory calibration restored
			3	ABC calibration
			4	Target calibration
			5	Background calibration
			6	Zero calibration
			7	
			8	
			9	
			10	
			11	
			12	
			13	
14				
15				
HR34	0x21	Start Single Measurement	Writing 1 to this register initiates a measurement if the sensor is configured for single measurement mode.	
HR35	0x22	ABC Time	Time passed since last ABC calibration in hours. If ABC is enabled when sensor is used in single measurement mode and powered down between measurements, the host system must read this register from the sensor after each measurement, increment its value every hour and write back to the sensor after each power on (enable) before a new measurement is triggered.	
HR36	0x23	ABC Par0	If ABC is enabled when sensor is used in single measurement mode and powered down between measurements, these registers must be read from the sensor after each measurement and written back to the sensor after each power on (enable) before a new measurement is triggered.	
HR37	0x24	ABC Par1		
HR38	0x25	ABC Par2		
HR39	0x26	ABC Par3		

| | | |
Senseair

| | | |

HR40	0x27	Filter Par0	If the sensor is used in single measurement mode with IIR filter enabled and powered down between measurements, these registers have to be read from the sensor after each measurement and written back to the sensor after each power on (enable) before a new measurement is triggered.
HR41	0x28	Filter Par1	
HR42	0x29	Filter Par2	
HR43	0x2A	Filter Par3	
HR44	0x2B	Filter Par4	
HR45	0x2C	Filter Par5	
HR46	0x2D	Filter Par6	
HR47	0x2E	Barometric air pressure value	Barometric air pressure value. Signed 16 bit, unit 0.1 hPa. Range from 3000 – 13000 (300 – 1300 hPa). For values outside pressure range, error flag “out of range” will be set and compensation will be done with min or max pressure value.
HR48	0x2F	ABC barometric pressure value	If pressure compensation and ABC are both enabled when sensor is used in single measurement mode and powered down between measurements, this register must be read from the sensor after each measurement and written back to the sensor after each power on (enable) before a new measurement is triggered.

Table 2. Holding Registers (HR)

Registers with (EE) after their names use sensors EEPROM, this means that too frequent writes to these registers will lead to a corrupt EEPROM. Total number of EEPROM write cycles should be less than 10000.

When writing multiple (EE) registers in one sequence then this write cycle will be counted as just ONE write cycle out of the 10000 that are allowed writes to the EEPROM.

It is important to wait until response from sensor is received before powering down the sensor. If sensor is powered down when EEPROM write operations are ongoing it may result in corrupt parameters.

Registers marked as “Reserved” can be read and written, however it is strongly recommended to not use these registers.



3. Examples

3.1. Read Error Status and gas concentration

Reading input IR1 to IR4 (Error Status, IR2, IR3, gas concentration).

Request(hex):

68 04 00 00 00 04 F8 F0
CRC

Response(hex):

68 04 08 00 00 00 00 00 00 05 47 B7 F2
Error status gas CRC

Error status = 0

Gas concentration = 1351

For details about CRC calculation see [1].

3.2. Set measurement mode to single measurement mode

Write 1 to HR11. Note that after measurement mode has been written to the sensor, it has to be restarted before it will change to the new measurement mode.

Request(hex):

68 10 00 0A 00 01 02 00 01 A5 68

Response(hex):

68 10 00 0A 00 01 28 F2

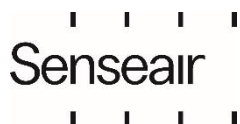

3.3. Communication sequence for single measurement mode

Example of communication sequence in single measurement mode when sensor is powered up/down by enable pin.

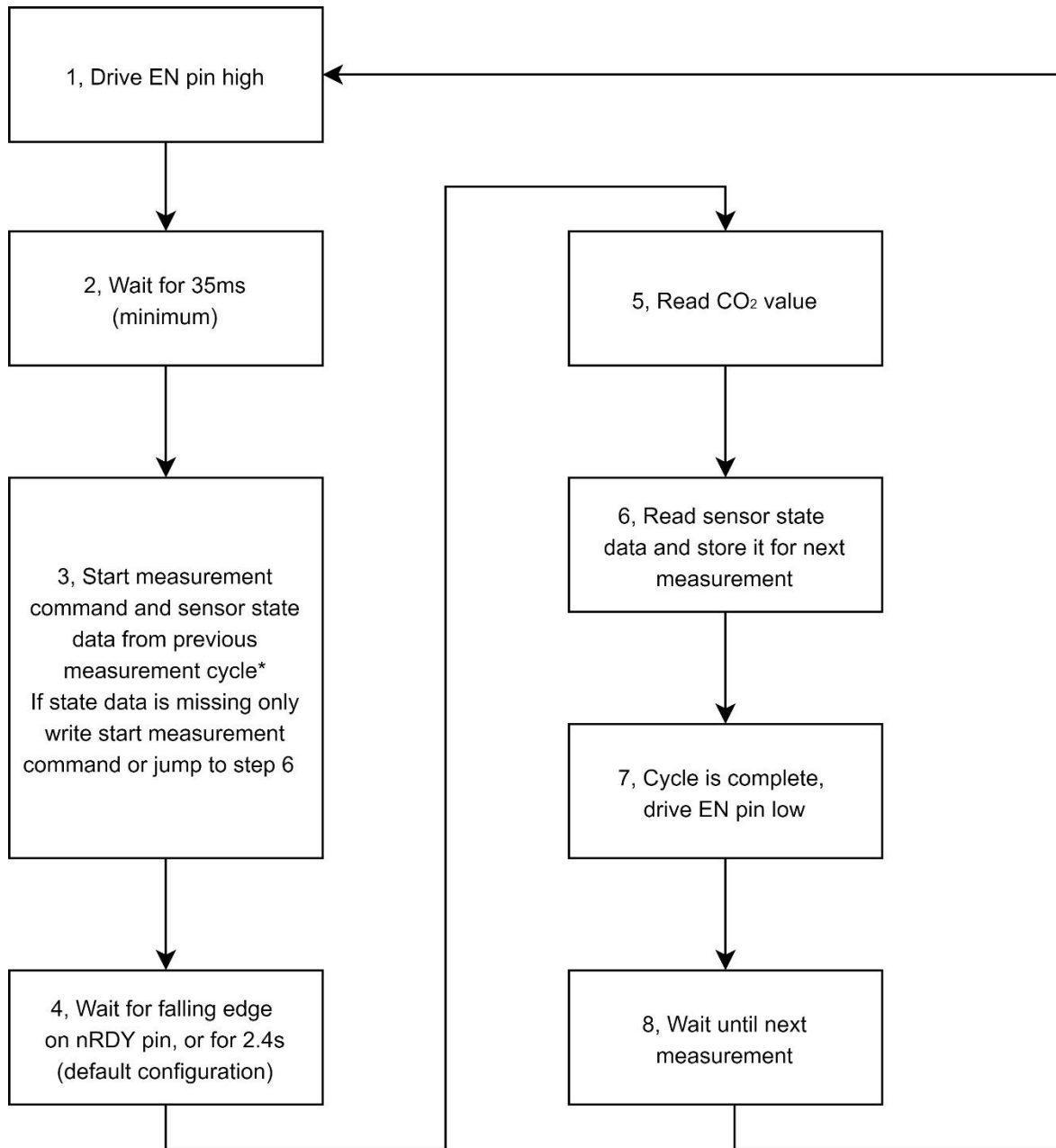

*If start measurement command and state data is written in two separate write sequences, state data must be written before start measurement command

Figure 1, Communication sequence for single measurement mode

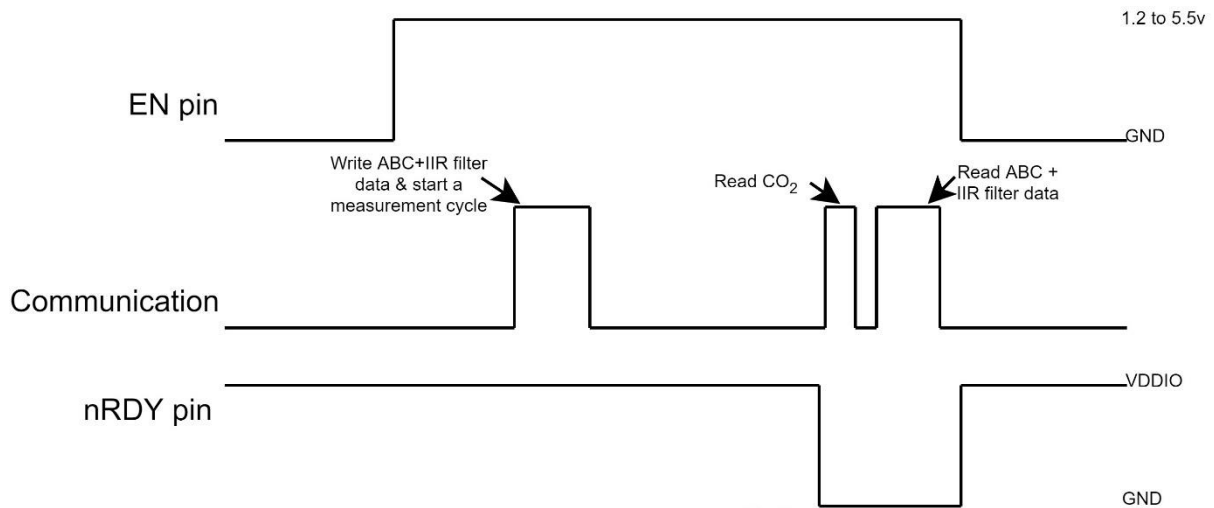

Figure 2, Timing diagram for single measurement mode

1. Drive EN pin high (>1.2V)
2. Wait for minimum 35ms for sensor start-up and stabilisation
3. If state data exists, go to point 3.1, otherwise go to point 3.2

3.1. Sensor state data exist

If pressure compensation is not enabled write start measurement command and state data to HR34 – HR46.

Request(hex):

```
68 10 00 21 00 0D 1A 00 01 00 00 00 00 00 00 7F FF 00 08 00 02 00 01 00 01 97 DC 00 F5
FF 64 00 F5 07 7B
```

Response(hex):

```
68 10 00 21 00 0D 58 FF
```

If pressure compensation is enabled, pressure (HR47) can be written together with measurement command and state data.

In this example pressure 1050 hPa is used ($1050 \times 10 = 10500 = 0x2904$)

Request(hex):

```
68 10 00 21 00 0E 1C 00 01 00 00 00 00 00 00 7F FF 00 08 00 02 00 01 00 01 97 DC 00 F5
FF 64 00 F5 29 04 DF B4
```

Response(hex):

```
68 10 00 21 00 0E 18 FE
```

Senseair

■ ■ ■ ■

3.2. State data does not exist, or it is an initial measurement

If host device has no state data, it is very important that host do not write "0" or any arbitrary data to HR36-HR46 first time it starts a measurement.

There are 2 options for this condition:

a) Start measurement command to HR34

If pressure compensation is enabled write pressure to HR47 before writing the start measurement command.

Write start measurement command

Request(hex):

68 10 00 21 00 01 02 00 01 A3 73

Response(hex):

68 10 00 21 00 01 58 FA

b) Jump to point 6 immediately to read and save state data from the sensor before the initial measurement.

4. Wait until ready pin goes low or 2.4s (for default configuration)

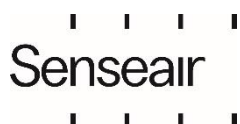

5. Read register IR1-IR4 (Error Status, IR2, IR3, gas concentration).

Request(hex):

68 04 00 00 00 04 F8 F0

Response(hex):

68 04 08 00 00 00 00 00 00 05 75 36 27

Error status

gas

Error status = 0

Gas concentration = 1397

6. Read sensor state data from HR35-HR46 and save it for next measurement.

Request(hex):

68 03 00 22 00 0C EC FC

Response(hex):

68 03 18 00 00 00 00 00 00 7F FF 00 08 00 02 00 01 00 01 97 DC 00 F5 FF 64 00 F5 5A FB

7. Drive EN pin low (<0.4V)

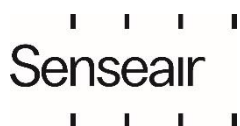

3.4. Enable/Disable ABC

Enable and disable ABC by writing to HR14 and HR19.

Enable ABC:

1. Clear bit1 in HR19

Start by reading HR19.

Request(hex):

68 03 00 12 00 01 2D 36

Response(hex):

68 03 02 00 F2 65 C8

Clear bit1 in register and write back

HR19 = HR19 & 0xFFFFD = 0x00F2 & 0xFFFFD = 0x00F0

Write back new HR19 value.

Request(hex):

68 10 00 12 00 01 02 00 F0 67 34

Response(hex):

68 10 00 12 00 01 A8 F5

2. Read HR14 and verify that it is desired ABC period.

Request(hex):

68 03 00 0D 00 01 1C F0

Response(hex):

68 03 02 00 B4 E4 3A

3. If HR14 (ABC period) is not the desired period, write desired ABC period to HR14. In this example ABC period is set to 200 hours.

Request(hex):

68 10 00 0D 00 01 02 00 C8 64 89

Response(hex):

68 10 00 0D 00 01 99 33

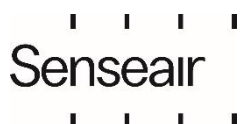

Disable ABC:

1. Set bit1 in HR19

Start by reading HR19.

Request(hex):

68 03 00 12 00 01 2D 36

Response(hex):

68 03 02 00 F0 E4 09

Set bit1 in register and write back.

$HR19 = HR19 | 0x0002 = 0x00F0 | 0x0002 = 0x00F2$

Write back new HR19 value.

Request(hex):

68 10 00 12 00 01 02 00 F2 E6 F5

Response(hex):

68 10 00 12 00 01 A8 F5

A possible alternative is to set HR14 to zero.

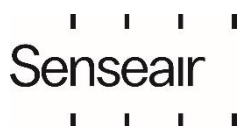

3.5. Enable/Disable dynamic IIR filter

Enable and disable dynamic IIR filtration by writing to HR19.

Enable dynamic IIR filter.

Start by reading HR19.

Request(hex):

68 03 00 12 00 01 2D 36

Response(hex):

68 03 02 00 FF A4 0D

Clear bit2 and bit3 in register and write back

$HR19 = HR19 \& 0xFFFF3 = 0x00FF \& 0xFFFF3 = 0x00F3$

Write back new HR19 value.

Request(hex):

68 10 00 12 00 01 02 00 F3 27 35

Response(hex):

68 10 00 12 00 01 A8 F5

Disable static and dynamic IIR filter.

Start by reading HR19.

Request(hex):

68 03 00 12 00 01 2D 36

Response(hex):

68 03 02 00 F3 A4 08

Set bit 2 and bit 3 in HR19 and write back.

$HR19 = HR19 | 0x000C = 0x00F3 | 0x000C = 0x00FF$

Write back new HR19 value.

Request(hex):

68 10 00 12 00 01 02 00 FF 27 30

Response(hex):

68 10 00 12 00 01 A8 F5

3.6. Background Calibration

Trig a background calibration and read calibration status after calibration.

Continuous measurement mode

Write background calibration command (0x7C06) to HR2

Request:

68 10 00 01 00 01 02 7C 06 C5 11

Response:

68 10 00 01 00 01 59 30

Read calibration status from HR1

Request:

68 03 00 00 00 01 8D 33

Response:

68 03 02 00 20 E5 95

HR1 = 0x20

To achieve best possible result from calibration it is important that the sensor is in a stable environment.

Single measurement mode

Flowchart presents the calibration sequence in single measurement mode.

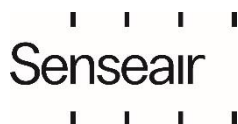
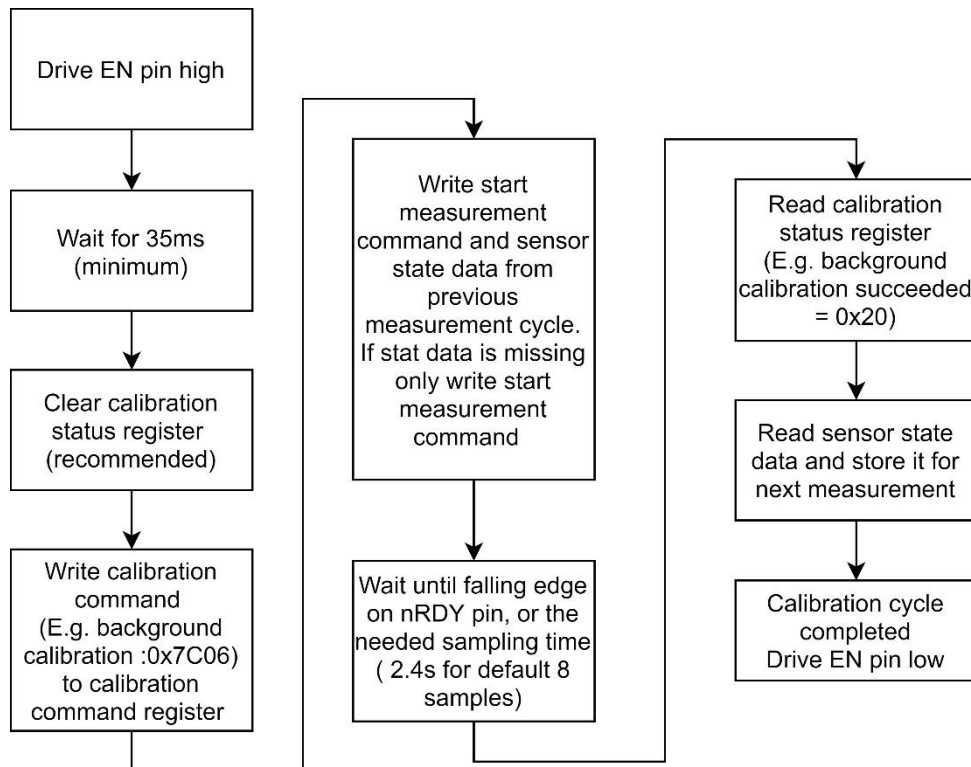

3.7. Target Calibration

Example how to calibrate against target 500 ppm.

Write calibration target 500 to HR3

Request:

68 10 00 02 00 01 02 01 F4 65 F7

Response:

68 10 00 02 00 01 A9 30

Write calibration command (0x7C05) to HR2

Request:

68 10 00 01 00 01 02 7C 05 85 10

Response:

68 10 00 01 00 01 59 30

Read calibration status from HR1.

Request:

68 03 00 00 00 01 8D 33

Response:

68 03 02 00 10 E5 81

HR1 = 0x10

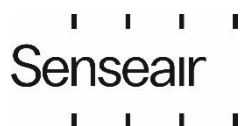

3.8. Set Modbus address

Set sensors Modbus address to 10.

Request:

68 10 00 13 00 01 02 00 0A E6 A6

Response:

68 10 00 13 00 01 F9 35

Sensor starts to use new address after a sensor reset (reset command or power cycle).

3.9. Pressure compensation

Enable and disable pressure compensation by writing to HR19. When pressure compensation is enabled, sensor will use value in HR47 to pressure compensate gas. If no value has been written to HR47 no pressure compensation will be done.

Enable pressure compensation.

Start by reading HR19.

Request(hex):

68 03 00 12 00 01 2D 36

Response(hex):

68 03 02 00 FF A4 0D

Clear bit4 in register and write back

$HR19 = HR19 \& 0xFFEF = 0x00FF \& 0xFFEF = 0x00EF$

Write back new HR19 value.

Request(hex):

68 10 00 12 00 01 02 00 EF 26 FC

Response(hex):

68 10 00 12 00 01 A8 F5

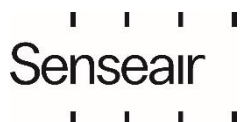

Disable pressure compensation.

Start by reading HR19.

Request(hex):

68 03 00 12 00 01 2D 36

Response(hex):

68 03 02 00 EF A5 C1

Set bit 4 in register and write back.

HR19 = HR19 | 0x0010 = 0x00EF | 0x0010 = 0x00FF

Write back new HR19 value.

Request(hex):

68 10 00 12 00 01 02 00 FF 27 30

Response(hex):

68 10 00 12 00 01 A8 F5

3.10. Write pressure to sensor

Write pressure 997 hPa to sensor HR47. Sensor works with unit 0.1 hPa so value to write to the sensor has to be calculated

Value to write = $997 * 10 = 9970$.

Request:

68 10 00 2E 00 01 02 26 F2 F9 A9

Response:

68 10 00 2E 00 01 68 F9

If pressure compensation is enabled, and a value has been written to HR47, the sensor will pressure compensate gas. If value written to sensor is not in the range 3000 – 13000, the sensor will use 3000 or 13000 for the pressure compensation.

Pressure value written to the sensor will be used in the next gas calculation. In continuous measurement mode this means that it can take up to one measurement period before pressure compensated measured concentration is based on the new pressure value.

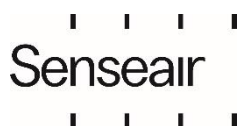

4. Revision history

Date	Revision	Page (s)	Description
2019-05-15	1-8	All	Sunrise FW rev. <=2.00, article number 006-0-0002
2021-03-23	9	14, 16, 17 21,22, 33	Sunrise FW rev. >=3.00, article number 006-0-0007 Page 14 IR24, Firmware type added Page 16 HR13, sample time changed from max 200ms to 300ms & instead of 0.2 it became 0.3 Page 17 HR19, nRDY invert added Page 21 Figure1- point 4 updated from 2s to 2.2s (Max measurement time with default settings). Page 22 Figure 2, - T_ (one sample + CO2 calculation) typical 180ms - Steady state current during sampling 99mA - MCU active current 10mA Page 33 Revision history added
2021-03-31	10	15, 19, 29	Page 15 HR2, Comments regarding calibration process in single measurement mode Page 19 HR48, ABC pressure value Page 29 Calibration sequence flowchart in single measurement mode
2021-11-19	11	All	Pressure compensated value can exceed 10000ppm. Page 1, 3, 11 Added "and Sunlight" Changed "CO2 value" to "measured concentration" Changed "CO2" to "gas" (Examples fig 1, fig 2, exceptions) Changed sidefoot: logo, added "©2019 Senseair AB. All rights reserved" Page 9 Added "/Sunlight" and "/8" in Product Code = "Sunrise" / "Sunlight" (length 7/8 bytes) Page 12 Changed "I2C error" to "Communication error" Changed "I2C protocol implementation" to "communication protocol implementation" Page 13 Deleted " Pressure compensated value can exceed 10000ppm "
2022-01-25	12	12 12 12 13 16 18 19 22	Description for "Low internal regulated voltage" bit changed Description for "Out of range" bit changed Description for "self-diagnostic" bit changed Description for "Abnormal signal level" bit added Add note regarding rounding for HR13 register Update description for "ABC Time" register Remove note about EEPROM update time as it included in Modbus "Response time-out" Remove "Current" graph from Figure 2
2022-02-11	13	23	Description for "Sensor state data do not exist" changed

www.senseair.com

