

Data sheet | Item number: 2202-1872

4-conductor disconnect/test terminal block; with push-button; with test option; orange disconnect link; for DIN-rail 35 x 15 and 35 x 7.5; 2.5 mm²; Push-in CAGE CLAMP®; 2,50 mm²; orange

www.wago.com/2202-1872

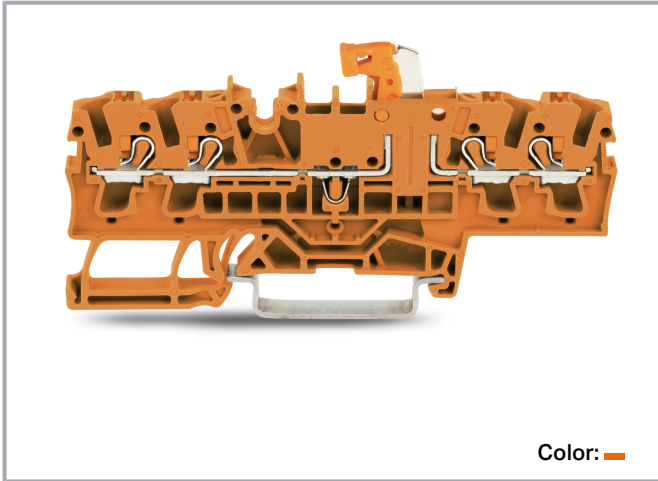

Color: 

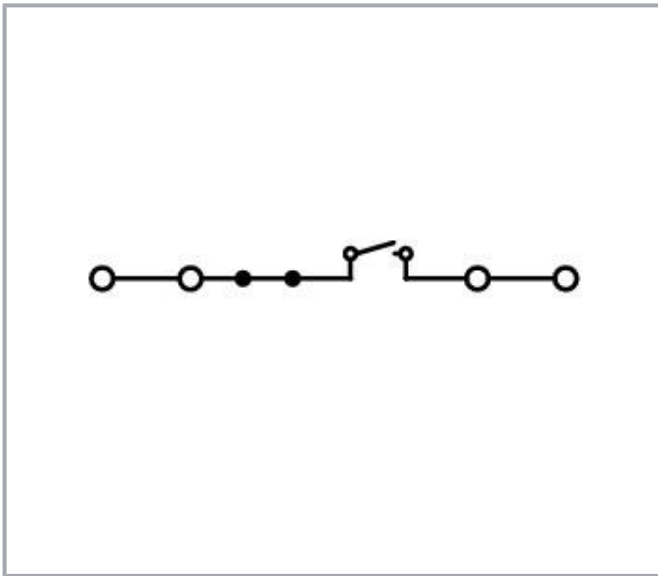
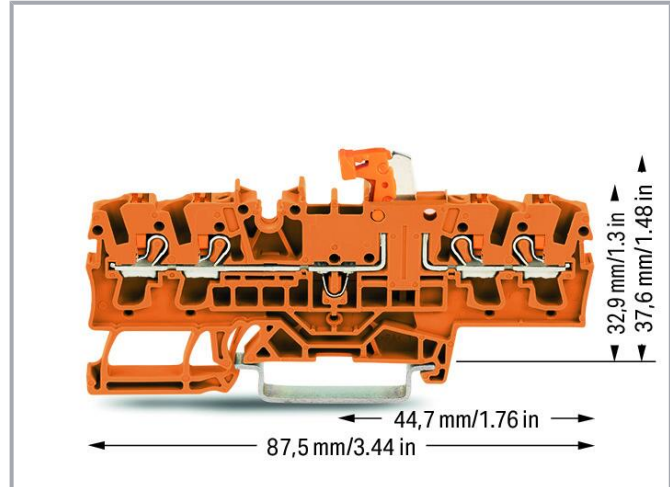

Data

Electrical data

Ratings per IEC/EN

Ratings per	IEC/EN 60947-7-1
Nominal voltage (III/3)	400 V

Subject to changes. Please also observe the further product documentation!

WAGO GmbH & Co. KG
Hansastr. 27
32423 Minden
Phone: +49571 887-0 | Fax: +49571 887-169
Email: info.de@wago.com | Web: www.wago.com

Do you have any questions about our products?
We are always happy to take your call at +49 (571) 887-44222.



Rated impulse voltage (III/3)	6 kV
Rated current	16 A
Legend (ratings)	(III / 3) ≙ Overvoltage category III / Pollution degree 3

Ratings per UL 1059

Approvals per	UL 1059
Rated voltage UL (Use Group B)	300 V
Rated current UL (Use Group B)	15 A
Rated voltage UL (Use Group C)	300 V
Rated current UL (Use Group C)	15 A

Ratings per CSA

Approvals per	CSA 22.2 No 158
Rated voltage CSA (Use Group B)	300 V
Rated current CSA (Use Group B)	15 A
Rated voltage CSA (Use Group C)	300 V
Rated current CSA (Use Group C)	15 A

Ex information

Reference hazardous areas	See "Downloads – Documentation – Additional Information: Technical Section; Technical Explications"
Ratings per	ATEX: PTB 20 ATEX 1007 U / IECEx: PTB 20.0013U (Ex ec IIC Gc)
Rated voltage EN (Ex e II)	440 V
Rated current (Ex e II)	17 A

Power loss

Power loss, per pole (potential)	0.341 W
Rated current I_N for specified power loss	16 A
Resistance value for specified, current-dependent power loss	0.001 Ω

Connection data

Connection points	4
Number of levels	1
Number of jumper slots	2

Subject to changes. Please also observe the further product documentation!



Connection 1

Connection technology	Push-in CAGE CLAMP®
Actuation type	Push-button
Connectable conductor materials	Copper
Nominal cross-section	2.5 mm ²
Solid conductor	0.25 ... 4 mm ² / 22 ... 12 AWG
Solid conductor; push-in termination	0.75 ... 4 mm ² / 18 ... 12 AWG
Fine-stranded conductor	0.25 ... 4 mm ² / 22 ... 12 AWG
Fine-stranded conductor; with insulated ferrule	0.25 ... 2.5 mm ² / 22 ... 14 AWG
Fine-stranded conductor; with ferrule; push-in termination	1 ... 2.5 mm ² / 18 ... 14 AWG
Note (conductor cross-section)	Depending on the conductor characteristic, a conductor with a smaller cross-section can also be inserted via push-in termination.
Strip length	10 ... 12 mm / 0.39 ... 0.47 inches
Wiring direction	Front-entry wiring

Physical data

Width	5.2 mm / 0.205 inches
Height	87.5 mm / 3.445 inches
Depth from upper-edge of DIN-rail	32.9 mm / 1.295 inches

Mechanical Data

Mounting type	DIN-35 rail
Marking level	Center/side marking

Material Data

Note (material data)	Information on material specifications can be found here
Color	orange
Material group	I
Insulation material	Polyamide (PA66)
Flammability class per UL94	V0
Fire load	0.032 MJ
Weight	10.2 g

Subject to changes. Please also observe the further product documentation!

Environmental requirements

Processing temperature	-35 ... +85 °C
Continuous operating temperature	-60 ... +105 °C

Commercial data



ETIM 8.0	EC000902
ETIM 7.0	EC000902
PU (SPU)	50 pcs
Packaging type	BOX
Country of origin	DE
GTIN	4055143974929
Customs tariff number	85365080900

Environmental Product Compliance

RoHS Compliance Status	Compliant, No Exemption
------------------------	-------------------------

Approvals / Certificates

General approvals

Logo	Approval	Additional Approval Text	Certificate name
	CSA DEKRA Certification B.V.	C22.2	70173745
	UL Underwriters Laboratories Inc.	UL 1059	E45172
	UL Underwriters Laboratories Inc.	UL 1059	E45172

Declarations of conformity and manufacturer's declarations

Logo	Approval	Additional Approval Text	Certificate name
	EU-Declaration of Conformity WAGO GmbH & Co. KG	-	-



Subject to changes. Please also observe the further product documentation!



UK-Declaration of Conformity



WAGO GmbH & Co. KG

Approvals for hazardous areas

Logo	Approval	Additional Approval Text	Certificate name
	ATEX Physikalisch Technische Bundesanstalt	EN IEC 60079-0	PTB 20 ATEX 1007U (II 3 G Ex ec IIC Gc)
	CCC CNEX	-	2020312313000288 (Ex ec IIC Gc)
	IECEX Physikalisch Technische Bundesanstalt	IEC 60079	IECEX PTB 20.0013U (Ex ec IIC Gc)

Required accessories

End plate

End plate		
	Item no.: 209-191 Separator for Ex e/Ex i applications; 3 mm thick; 120 mm wide; orange	www.wago.com/209-191
	Item no.: 2002-1892 End and intermediate plate; 1 mm thick; orange	www.wago.com/2002-1892
	Item no.: 2002-1891 End and intermediate plate; 1 mm thick; gray	www.wago.com/2002-1891

Optional accessories

Insulation stop

Insulation stop		
	Item no.: 2002-171 Insulation stop; 0.25 - 0.5 mm ² ; 5 pieces/strip; light gray	www.wago.com/2002-171

Subject to changes. Please also observe the further product documentation!

WAGO GmbH & Co. KG

Hansastr. 27

32423 Minden

Phone: +49571 887-0 | Fax: +49571 887-169

Email: info.de@wago.com | Web: www.wago.com

Do you have any questions about our products?

We are always happy to take your call at +49 (571) 887-44222.



Item no.: 2002-172
Insulation stop; 0.75 - 1 mm²; 5 pieces/strip; dark gray

www.wago.com/2002-172

Jumpers

Jumper



Item no.: 210-123
Wire commoning chain; insulated; blue

www.wago.com/210-123



Item no.: 2002-402
Jumper; 2-way; insulated; light gray

www.wago.com/2002-402



Item no.: 2002-402/000-005
Jumper; 2-way; insulated; red

www.wago.com/2002-402/000-005



Item no.: 2002-400
Continuous jumper; 2-way; insulated; light gray

www.wago.com/2002-400



Item no.: 2002-403
Jumper; 3-way; insulated; light gray

www.wago.com/2002-403



Item no.: 2002-404/000-005
Jumper; 4-way; insulated; red

www.wago.com/2002-404/000-005



Item no.: 2002-403/000-006
Jumper; 3-way; insulated; blue

www.wago.com/2002-403/000-006



Item no.: 2002-404/000-006
Jumper; 4-way; insulated; blue

www.wago.com/2002-404/000-006



Item no.: 2002-403/000-005
Jumper; 3-way; insulated; red

www.wago.com/2002-403/000-005



Item no.: 2002-405/000-005
Jumper; 5-way; insulated; red

www.wago.com/2002-405/000-005



Item no.: 2002-402/000-006
Jumper; 2-way; insulated; blue

www.wago.com/2002-402/000-006



Item no.: 2002-405/000-006
Jumper; 5-way; insulated; blue













www.wago.com/2002-405/000-006

















Item no.: 2002-404
Jumper; 4-way; insulated; light gray

www.wago.com/2002-404

Subject to changes. Please also observe the further product documentation!

	Item no.: 2002-406/000-006 Jumper; 6-way; insulated; blue	www.wago.com/2002-406/000-006
	Item no.: 2002-406/000-005 Jumper; 6-way; insulated; red	www.wago.com/2002-406/000-005
	Item no.: 2002-406/020-000 Delta jumper; insulated; light gray	www.wago.com/2002-406/020-000
	Item no.: 2002-405 Jumper; 5-way; insulated; light gray	www.wago.com/2002-405
	Item no.: 2002-407/000-005 Jumper; 7-way; insulated; red	www.wago.com/2002-407/000-005
	Item no.: 2002-408 Jumper; 8-way; insulated; light gray	www.wago.com/2002-408
	Item no.: 2002-408/000-006 Jumper; 8-way; insulated; blue	www.wago.com/2002-408/000-006
	Item no.: 2002-405/011-000 Star point jumper; 3-way; insulated; light gray	www.wago.com/2002-405/011-000
	Item no.: 2002-407/000-006 Jumper; 7-way; insulated; blue	www.wago.com/2002-407/000-006
	Item no.: 2002-408/000-005 Jumper; 8-way; insulated; red	www.wago.com/2002-408/000-005
	Item no.: 2002-407 Jumper; 7-way; insulated; light gray	www.wago.com/2002-407
	Item no.: 2002-406 Jumper; 6-way; insulated; light gray	www.wago.com/2002-406

Subject to changes. Please also observe the further product documentation!

	Item no.: 2002-410/000-005 Jumper; 10-way; insulated; red	www.wago.com/2002-410/000-005
	Item no.: 2002-410/000-006 Jumper; 10-way; insulated; blue	www.wago.com/2002-410/000-006
	Item no.: 2002-410 Jumper; 10-way; insulated; light gray	www.wago.com/2002-410
	Item no.: 2002-409/000-006 Jumper; 9-way; insulated; blue	www.wago.com/2002-409/000-006
	Item no.: 2002-409/000-005 Jumper; 9-way; insulated; red	www.wago.com/2002-409/000-005
	Item no.: 2002-409 Jumper; 9-way; insulated; light gray	www.wago.com/2002-409
	Item no.: 2002-423/000-006 Continuous jumper; from 1 to 3; insulated; blue	www.wago.com/2002-423/000-006
	Item no.: 2002-423 Continuous jumper; from 1 to 3; insulated; light gray	www.wago.com/2002-423
	Item no.: 2002-433 Jumper; from 1 to 3; insulated; light gray	www.wago.com/2002-433
	Item no.: 2002-434 Jumper; from 1 to 4; insulated; light gray	www.wago.com/2002-434
	Item no.: 2002-423/000-005 Continuous jumper; from 1 to 3; insulated; red	www.wago.com/2002-423/000-005
	Item no.: 2002-435 Jumper; from 1 to 5; insulated; light gray	www.wago.com/2002-435
	Item no.: 2002-436 Jumper; from 1 to 6; insulated; light gray	www.wago.com/2002-436
	Item no.: 2002-437 Jumper; from 1 to 7; insulated; light gray	www.wago.com/2002-437
	Item no.: 2002-438	www.wago.com/2002-438

Subject to changes. Please also observe the further product documentation!

Jumper; from 1 to 8; insulated; light gray



Item no.: 2002-439

Jumper; from 1 to 9; insulated; light gray

www.wago.com/2002-439



Item no.: 2002-440

Jumper; from 1 to 10; insulated; light gray

www.wago.com/2002-440



Item no.: 2002-472

Staggered jumper; 2-way; insulated; light gray

www.wago.com/2002-472



Item no.: 2002-473

Staggered jumper; 3-way; insulated; light gray

www.wago.com/2002-473



Item no.: 2002-475/011-000

Staggered jumper; 3-way; insulated; light gray

www.wago.com/2002-475/011-000



Item no.: 2002-475

Staggered jumper; 5-way; insulated; light gray

www.wago.com/2002-475



Item no.: 2002-476

Staggered jumper; 6-way; insulated; light gray

www.wago.com/2002-476



Item no.: 2002-474

Staggered jumper; 4-way; insulated; light gray

www.wago.com/2002-474



Item no.: 2002-477

Staggered jumper; 7-way; insulated; light gray

www.wago.com/2002-477



Item no.: 2002-473/011-000

Staggered jumper; 2-way; from 1 to 3; insulated; light gray

www.wago.com/2002-473/011-000



Item no.: 2002-479

Staggered jumper; 9-way; insulated; light gray

www.wago.com/2002-479



Item no.: 2002-478

Staggered jumper; 8-way; insulated; light gray

www.wago.com/2002-478



Item no.: 2002-479/011-000

Staggered jumper; insulated; light gray

www.wago.com/2002-479/011-000



Item no.: 2002-480

Staggered jumper; 10-way; insulated; light gray

www.wago.com/2002-480



Item no.: 2002-477/011-000

Staggered jumper; insulated; light gray

www.wago.com/2002-477/011-000

Subject to changes. Please also observe the further product documentation!

WAGO GmbH & Co. KG

Hansastr. 27

32423 Minden

Phone: +49571 887-0 | Fax: +49571 887-169

Email: info.de@wago.com | Web: www.wago.com

Do you have any questions about our products?

We are always happy to take your call at +49 (571) 887-44222.



Item no.: 2002-481/011-000
Staggered jumper; insulated; light gray

www.wago.com/2002-481/011-000



Item no.: 2002-481
Staggered jumper; 11-way; insulated; light gray

www.wago.com/2002-481



Item no.: 2002-482
Staggered jumper; 12-way; insulated; light gray

www.wago.com/2002-482



Item no.: 210-103
Wire commoning chain; insulated; black

www.wago.com/210-103



Item no.: 2002-424/000-006
Continuous jumper; from 1 to 4; insulated; blue

www.wago.com/2002-424/000-006

Mounting

Cover carrier



Item no.: 709-169
Cover carrier; Type 3; gray

www.wago.com/709-169

Cover



Item no.: 709-156
Cover; Type 3; suitable for cover carrier, type 3; 1 m long; transparent

www.wago.com/709-156

Testing and measuring

Testing accessories



Item no.: 2009-174
Test plug adapter; for 4 mm Ø test plugs; for testing TOPJOB®S rail-mounted terminal blocks; gray

www.wago.com/2009-174



Item no.: 2009-182
Testing tap; for max. 2.5 mm²; tool-free connection for individual test wires 0.08 - 2.5 mm; gray

www.wago.com/2009-182



Item no.: 2002-511
Modular TOPJOB®S connector; modular; for jumper contact slot; 1-pole; 2,50 mm²; gray

www.wago.com/2002-511



Item no.: 2002-549
Spacer module; modular; e.g., for bridging commoned terminal blocks; gray

www.wago.com/2002-549



Item no.: 2002-552
Modular TOPJOB®S connector; modular; for jumper contact slot; 2-pole; 2,50 mm²; gray

www.wago.com/2002-552



Item no.: 2002-558
Modular TOPJOB®S connector; modular; for jumper contact slot; 8-pole; 2,50 mm²; gray









www.wago.com/2002-558



Item no.: 2002-559
Modular TOPJOB®S connector; modular; for jumper contact slot; 9-pole; 2,50 mm²; gray







www.wago.com/2002-559

Subject to changes. Please also observe the further product documentation!



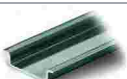

	Item no.: 2002-556 Modular TOPJOB®S connector; modular; for jumper contact slot; 6-pole; 2,50 mm ² ; gray	www.wago.com/2002-556
	Item no.: 2002-553 Modular TOPJOB®S connector; modular; for jumper contact slot; 3-pole; 2,50 mm ² ; gray	www.wago.com/2002-553
	Item no.: 2002-560 Modular TOPJOB®S connector; modular; for jumper contact slot; 10-pole; 2,50 mm ² ; gray	www.wago.com/2002-560
	Item no.: 2002-554 Modular TOPJOB®S connector; modular; for jumper contact slot; 4-pole; 2,50 mm ² ; gray	www.wago.com/2002-554
	Item no.: 2002-555 Modular TOPJOB®S connector; modular; for jumper contact slot; 5-pole; 2,50 mm ² ; gray	www.wago.com/2002-555
	Item no.: 2002-557 Modular TOPJOB®S connector; modular; for jumper contact slot; 7-pole; 2,50 mm ² ; gray	www.wago.com/2002-557
	Item no.: 2002-649 TOPJOB®S L-type spacer module; modular; e.g., for bridging commoned terminal blocks; gray	www.wago.com/2002-649
	Item no.: 210-136 Test plug; 2 mm Ø; with 500 mm cable; red	www.wago.com/210-136

Carrier rail









Mounting accessories

	Item no.: 210-197 Steel carrier rail; 35 x 15 mm; 1.5 mm thick; 2 m long; slotted; similar to EN 60715; silver-colored	www.wago.com/210-197
	Item no.: 210-198 Copper carrier rail; 35 x 15 mm; 2.3 mm thick; 2 m long; unslotted; according to EN 60715; copper-colored	www.wago.com/210-198
	Item no.: 210-504 Steel carrier rail; 35 x 7.5 mm; 1 mm thick; 2 m long; slotted; galvanized; according to EN 60715; silver-colored	www.wago.com/210-504
	Item no.: 210-505 Steel carrier rail; 35 x 7.5 mm; 1 mm thick; 2 m long; unslotted; galvanized; according to EN 60715; silver-colored	www.wago.com/210-505
	Item no.: 210-506 Steel carrier rail; 35 x 15 mm; 1.5 mm thick; 2 m long; unslotted; galvanized; similar to EN 60715; silver-colored	www.wago.com/210-506
	Item no.: 210-508 Steel carrier rail; 35 x 15 mm; 1.5 mm thick; 2 m long; slotted; galvanized; similar to EN 60715; silver-colored	www.wago.com/210-508
	Item no.: 210-113 Steel carrier rail; 35 x 7.5 mm; 1 mm thick; 2 m long; unslotted; according to EN 60715; silver-colored	www.wago.com/210-113

Subject to changes. Please also observe the further product documentation!

	Item no.: 210-118 Steel carrier rail; 35 x 15 mm; 2.3 mm thick; 2 m long; unslotted; according to EN 60715; silver-colored	www.wago.com/210-118
	Item no.: 210-112 Steel carrier rail; 35 x 7.5 mm; 1 mm thick; 2 m long; slotted; according to EN 60715; "Hole width 25 mm; silver-colored	www.wago.com/210-112
	Item no.: 210-114 Steel carrier rail; 35 x 15 mm; 1.5 mm thick; 2 m long; unslotted; similar to EN 60715; silver-colored	www.wago.com/210-114
	Item no.: 210-115 Steel carrier rail; 35 x 7.5 mm; 1 mm thick; 2 m long; slotted; according to EN 60715; "Hole width 18 mm; silver-colored	www.wago.com/210-115
	Item no.: 210-196 Aluminum carrier rail; 35 x 8.2 mm; 1.6 mm thick; 2 m long; unslotted; similar to EN 60715; silver-colored	www.wago.com/210-196













Ferrule

Ferrule		
	Item no.: 216-241 Ferrule; Sleeve for 0.5 mm ² / 20 AWG; insulated; electro-tin plated; electrolytic copper; gastight crimped; acc. to DIN 46228, Part 4/09.90; white	www.wago.com/216-241
	Item no.: 216-242 Ferrule; Sleeve for 0.75 mm ² / 18 AWG; insulated; electro-tin plated; electrolytic copper; gastight crimped; acc. to DIN 46228, Part 4/09.90; gray	www.wago.com/216-242
	Item no.: 216-243 Ferrule; Sleeve for 1 mm ² / AWG 18; insulated; electro-tin plated; electrolytic copper; gastight crimped; acc. to DIN 46228, Part 4/09.90; red	www.wago.com/216-243
	Item no.: 216-244 Ferrule; Sleeve for 1.5 mm ² / AWG 16; insulated; electro-tin plated; electrolytic copper; gastight crimped; acc. to DIN 46228, Part 4/09.90; black	www.wago.com/216-244
	Item no.: 216-263 Ferrule; Sleeve for 1 mm ² / AWG 18; insulated; electro-tin plated; electrolytic copper; gastight crimped; acc. to DIN 46228, Part 4/09.90; red	www.wago.com/216-263
	Item no.: 216-246 Ferrule; Sleeve for 2.5 mm ² / AWG 14; insulated; electro-tin plated; electrolytic copper; gastight crimped; acc. to DIN 46228, Part 4/09.90; blue	www.wago.com/216-246
	Item no.: 216-266 Ferrule; Sleeve for 2.5 mm ² / AWG 14; insulated; electro-tin plated; electrolytic copper; gastight crimped; acc. to DIN 46228, Part 4/09.90; blue	www.wago.com/216-266
	Item no.: 216-264 Ferrule; Sleeve for 1.5 mm ² / AWG 16; insulated; electro-tin plated; electrolytic copper; gastight crimped; acc. to DIN 46228, Part 4/09.90; black	www.wago.com/216-264
	Item no.: 216-262 Ferrule; Sleeve for 0.75 mm ² / 18 AWG; insulated; electro-tin plated; electrolytic copper; gastight crimped; acc. to DIN 46228, Part 4/09.90; gray	www.wago.com/216-262













Marking accessories

Marking strip		
---------------	--	--

Subject to changes. Please also observe the further product documentation!

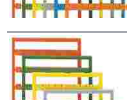
	Item no.: 2009-110 Marking strips; for Smart Printer; on reel; not stretchable; plain; snap-on type; white	www.wago.com/2009-110
Marker carrier		
	Item no.: 2009-198 Adaptor; gray	www.wago.com/2009-198
	Item no.: 2002-121 Adaptor; gray	www.wago.com/2002-121
	Item no.: 2002-161 Adaptor; gray	www.wago.com/2002-161
Marker		
	Item no.: 2009-115/000-002 WMB-Inline; for Smart Printer; 1500 pieces on roll; stretchable 5 - 5.2 mm; plain; snap-on type; yellow	www.wago.com/2009-115/000-002
	Item no.: 2009-115/000-007 WMB-Inline; for Smart Printer; 1500 pieces on roll; stretchable 5 - 5.2 mm; plain; snap-on type; gray	www.wago.com/2009-115/000-007
	Item no.: 2009-115/000-017 WMB-Inline; for Smart Printer; 1500 pieces on roll; stretchable 5 - 5.2 mm; plain; snap-on type; light green	www.wago.com/2009-115/000-017
	Item no.: 2009-115/000-023 WMB-Inline; for Smart Printer; 1500 pieces on roll; stretchable 5 - 5.2 mm; plain; snap-on type; green	www.wago.com/2009-115/000-023
	Item no.: 2009-115/000-024 WMB-Inline; for Smart Printer; 1500 pieces on roll; stretchable 5 - 5.2 mm; plain; snap-on type; violet	www.wago.com/2009-115/000-024
	Item no.: 2009-145/000-006 Mini-WSB Inline; for Smart Printer; 1700 pieces on roll; stretchable 5 - 5.2 mm; plain; snap-on type; blue	www.wago.com/2009-145/000-006
	Item no.: 2009-145 Mini-WSB Inline; for Smart Printer; 1700 pieces on roll; stretchable 5 - 5.2 mm; plain; snap-on type; white	www.wago.com/2009-145
	Item no.: 2009-145/000-002 Mini-WSB Inline; for Smart Printer; 1700 pieces on roll; stretchable 5 - 5.2 mm; plain; snap-on type; yellow	www.wago.com/2009-145/000-002
	Item no.: 2009-145/000-007 Mini-WSB Inline; for Smart Printer; 1700 pieces on roll; stretchable 5 - 5.2 mm; plain; snap-on type; gray	www.wago.com/2009-145/000-007

Subject to changes. Please also observe the further product documentation!

	Item no.: 2009-145/000-005 Mini-WSB Inline; for Smart Printer; 1700 pieces on roll; stretchable 5 - 5.2 mm; plain; snap-on type; red	www.wago.com/2009-145/000-005
	Item no.: 2009-145/000-012 Mini-WSB Inline; for Smart Printer; 1700 pieces on roll; stretchable 5 - 5.2 mm; plain; snap-on type; orange	www.wago.com/2009-145/000-012
	Item no.: 2009-145/000-023 Mini-WSB Inline; for Smart Printer; 1700 pieces on roll; stretchable 5 - 5.2 mm; plain; snap-on type; green	www.wago.com/2009-145/000-023
	Item no.: 2009-145/000-024 Mini-WSB Inline; for Smart Printer; 1700 pieces on roll; stretchable 5 - 5.2 mm; plain; snap-on type; violet	www.wago.com/2009-145/000-024
	Item no.: 2009-115 WMB-Inline; for Smart Printer; 1500 pieces on roll; stretchable 5 - 5.2 mm; plain; snap-on type; white	www.wago.com/2009-115
	Item no.: 248-501/000-006 Mini-WSB marking card; as card; not stretchable; plain; snap-on type; blue	www.wago.com/248-501/000-006
	Item no.: 248-501/000-007 Mini-WSB marking card; as card; not stretchable; plain; snap-on type; gray	www.wago.com/248-501/000-007
	Item no.: 248-501/000-002 Mini-WSB marking card; as card; not stretchable; plain; snap-on type; yellow	www.wago.com/248-501/000-002
	Item no.: 248-501/000-012 Mini-WSB marking card; as card; not stretchable; plain; snap-on type; orange	www.wago.com/248-501/000-012
	Item no.: 248-501 Mini-WSB marking card; as card; not stretchable; plain; snap-on type; white	www.wago.com/248-501
	Item no.: 248-501/000-017 Mini-WSB marking card; as card; not stretchable; plain; snap-on type; light green	www.wago.com/248-501/000-017
	Item no.: 248-501/000-005 Mini-WSB marking card; as card; not stretchable; plain; snap-on type; red	www.wago.com/248-501/000-005

Subject to changes. Please also observe the further product documentation!



Item no.: 248-501/000-024

Mini-WSB marking card; as card; not stretchable; plain; snap-on type; violet

www.wago.com/248-501/000-024



Item no.: 248-501/000-023

Mini-WSB marking card; as card; not stretchable; plain; snap-on type; green

www.wago.com/248-501/000-023



Item no.: 793-5501/000-007

WMB marking card; as card; for terminal block width 5 - 17.5 mm; stretchable 5 - 5.2 mm; plain; snap-on type; gray

www.wago.com/793-5501/000-007



Item no.: 793-5501/000-012

WMB marking card; as card; for terminal block width 5 - 17.5 mm; stretchable 5 - 5.2 mm; plain; snap-on type; orange

www.wago.com/793-5501/000-012



Item no.: 793-5501/000-014

WMB marking card; as card; for terminal block width 5 - 17.5 mm; stretchable 5 - 5.2 mm; plain; snap-on type; brown

www.wago.com/793-5501/000-014



Item no.: 793-5501/000-017

WMB marking card; as card; for terminal block width 5 - 17.5 mm; stretchable 5 - 5.2 mm; plain; snap-on type; light green

www.wago.com/793-5501/000-017



Item no.: 793-5501/000-023

WMB marking card; as card; for terminal block width 5 - 17.5 mm; stretchable 5 - 5.2 mm; plain; snap-on type; green

www.wago.com/793-5501/000-023



Item no.: 793-5501/000-024

WMB marking card; as card; for terminal block width 5 - 17.5 mm; stretchable 5 - 5.2 mm; plain; snap-on type; violet

www.wago.com/793-5501/000-024



Item no.: 793-5501/000-005

WMB marking card; as card; for terminal block width 5 - 17.5 mm; stretchable 5 - 5.2 mm; plain; snap-on type; red

www.wago.com/793-5501/000-005



Item no.: 793-5501/000-002

WMB marking card; as card; for terminal block width 5 - 17.5 mm; stretchable 5 - 5.2 mm; plain; snap-on type; yellow

www.wago.com/793-5501/000-002















Item no.: 793-5501/000-006

WMB marking card; as card; for terminal block width 5 - 17.5 mm; stretchable 5 - 5.2 mm; plain; snap-on type; blue

www.wago.com/793-5501/000-006

Subject to changes. Please also observe the further product documentation!

	Item no.: 793-5501 WMB marking card; as card; for terminal block width 5 - 17.5 mm; stretchable 5 - 5.2 mm; plain; snap-on type; white	www.wago.com/793-5501
	Item no.: 2009-115/000-012 WMB-Inline; for Smart Printer; 1500 pieces on roll; stretchable 5 - 5.2 mm; plain; snap-on type; orange	www.wago.com/2009-115/000-012
	Item no.: 2009-115/000-006 WMB-Inline; for Smart Printer; 1500 pieces on roll; stretchable 5 - 5.2 mm; plain; snap-on type; blue	www.wago.com/2009-115/000-006
	Item no.: 2009-115/000-005 WMB-Inline; for Smart Printer; 1500 pieces on roll; stretchable 5 - 5.2 mm; plain; snap-on type; red	www.wago.com/2009-115/000-005
Group marker carrier		
	Item no.: 2009-193 Group marker carrier; gray	www.wago.com/2009-193
	Item no.: 2009-192 Group marker carrier; gray	www.wago.com/2009-192
	Item no.: 2009-191 Group marker carrier; gray	www.wago.com/2009-191
Tool		
Operating tool		
	Item no.: 210-658 Operating tool; Blade: 3.5 x 0.5 mm; with a partially insulated shaft; angled; short; multicoloured	www.wago.com/210-658
	Item no.: 210-720 Operating tool; Blade: 3.5 x 0.5 mm; with a partially insulated shaft; multicoloured	www.wago.com/210-720
Push-in type wire jumper		
Jumper		
	Item no.: 2009-412 Push-in type wire jumper; insulated; 60 mm long; black	www.wago.com/2009-412
	Item no.: 2009-414 Push-in type wire jumper; 1.5 mm ² ; insulated; 110 mm long; black	www.wago.com/2009-414
	Item no.: 2009-416 Push-in type wire jumper; 1.5 mm ² ; insulated; 250 mm long; black	www.wago.com/2009-416
	Item no.: 2009-414/000-005 Push-in type wire jumper; 1.5 mm ² ; insulated; 110 mm long; black	www.wago.com/2009-414/000-005

Subject to changes. Please also observe the further product documentation!



Item no.: 2009-414/000-006
Push-in type wire jumper; insulated; 110 mm long; black

www.wago.com/2009-414/000-006

Downloads

Documentation

Additional Information

Technical Section	pdf	Download
Technical explanations	2.2 MB	

CAD/CAE-Data

CAD data

2D/3D Models 2202-1872	URL	Download
------------------------	-----	----------

Environmental Product Compliance

Compliance Search

Environmental Product Compliance 2202-1872	URL	Download
4-conductor disconnect/test terminal block; with push-button; with test option; orange disconnect link; for DIN-rail 35 x 15 and 35 x 7.5; 2.5 mm ² ; Push-in CAGE CLAMP®; 2,50 mm ² ; orange		

Installation Notes

Conductor termination

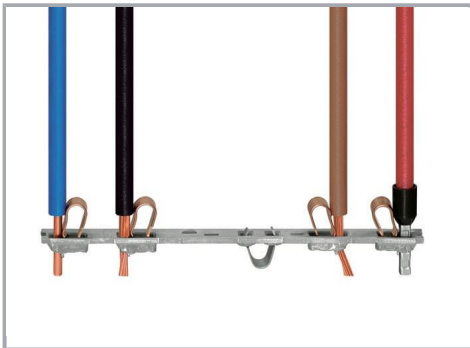

All conductor types at a glance



Push-in termination of solid and ferruled conductors

Subject to changes. Please also observe the further product documentation!

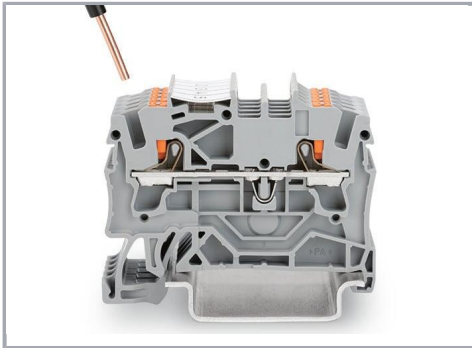

Push-in termination of solid and ferruled conductors

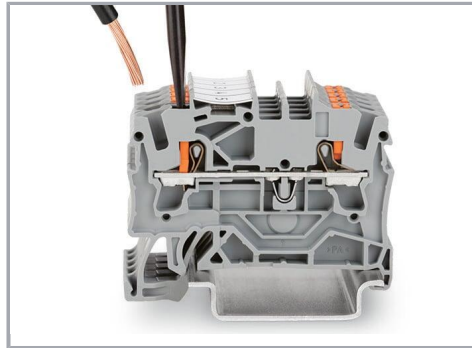

Insert fine-stranded conductors via operating tool.



Removing all conductors via operating tool.

Commoning



Insert a push-in type jumper bar and push down until it hits the backstop.

Marking

Subject to changes. Please also observe the further product documentation!

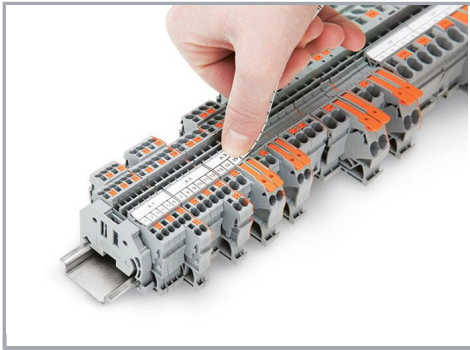

Snapping a marking strip into a marker slot.

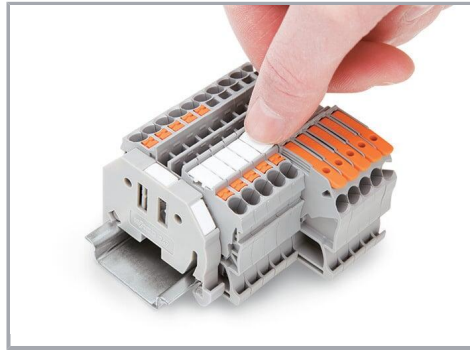

Snapping a marking strip into the marker slot.

Product family

TOPJOB® S

TOPJOB® S: In various industrial applications and modern building installations, WAGO's wide and versatile range of rail-mount terminal blocks provides more than just reliable electrical connections.

[Show all products from the family](#)

Subject to changes. Please also observe the further product documentation!