

Dimensions: [mm]

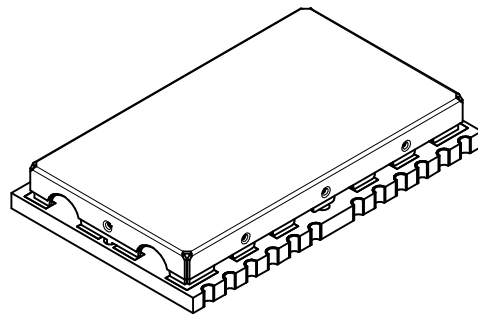

Scale - 2:1

Recommended Land Pattern: [mm]

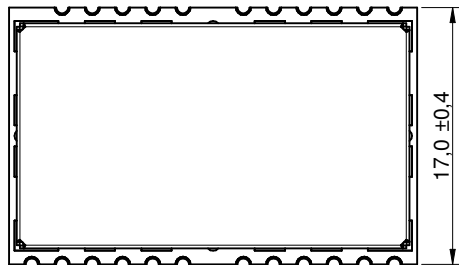
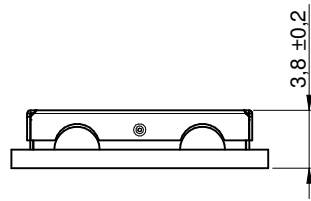
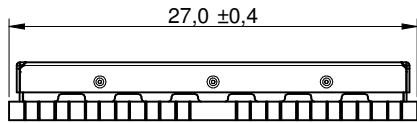
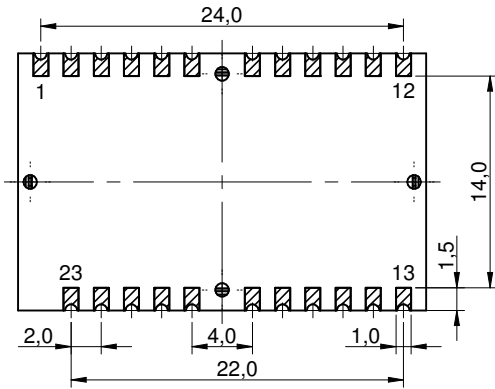
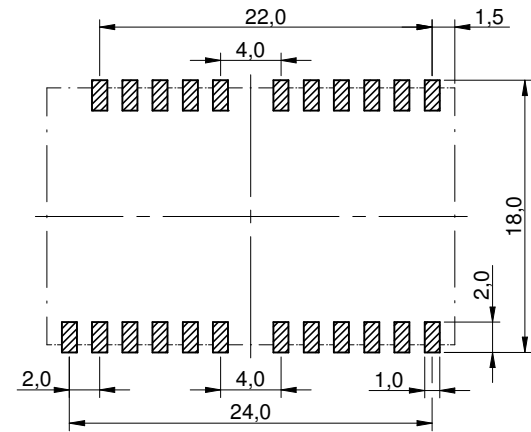

Scale - 2:1

Product Specific Pinning:

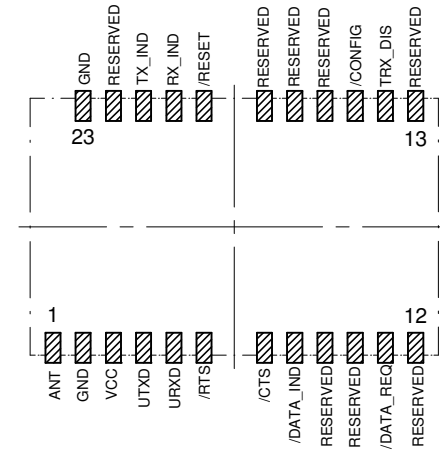

Scale - 2:1

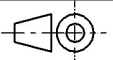
 <p>Würth Elektronik eiSos GmbH & Co. KG EMC & Inductive Solutions Max-Eyth-Str. 1 74638 Waldenburg Germany Tel. +49 (0) 79 42 945 - 0 www.we-online.com eiSos@we-online.com</p>	CHECKED GE	REVISION 002.000	DATE (YYYY-MM-DD) 2019-08-01	GENERAL TOLERANCE DIN ISO 2768-1m	PROJECTION METHOD 
	DESCRIPTION WIRL-PRO1 Radio module 169MHz				ORDER CODE 2607011111000
	BUSINESS UNIT eiSmart			STATUS Valid	PAGE 1/6

General Properties:

Properties		Test conditions	Value	Unit
Communication Protocol/ Standard	RF _{prot}		proprietary (P2P, star)	
Microcontroller	μC		MSP430	
Radio Chipset	RF-IC		TI - CC1120	
Memory Size (Flash)			65536	B
Memory Size (RAM)			6144	B
Radio channel min.			0	
Radio channel max.			4	
Interface 1	IO ₁		UART	
Interface 1 Bitrate Range	IO ₁ Bitrate	latest FW revision	115.2	kbps
Number of I/O Ports	IO _{Ports}	latest FW revision	6	

Electrical Properties:

Properties		Test conditions	Value	Unit
Operating Supply Voltage Min.	V _{DD min.}	TAMB = 25 °C, RH = 60 %	2	V
Operating Supply Voltage Max.	V _{DD max.}	TAMB = 25 °C, RH = 60 %	3.6	V
Recommended Supply Voltage	V _{DD typ.}	TAMB = 25 °C, RH = 60 %	3.3	V
Supply Current Sleep	I _{sleep}	VDD,typ,TAMB = 25 °C, RH = 60 %	10	μA

Additional General Information:

Ambient Temperature (referring to I _R)	-40 up to +85 °C
Operating Temperature	-40 up to +85 °C
Storage Conditions (in original packaging)	< 40 °C ; < 90 % RH

RF-Electrical Properties:

Properties		Test conditions	Value	Unit
Frequency min.	f _{min.}	VDD,typ,TAMB = 25 °C, RH = 60 %	169.4125	MHz
Frequency max.	f _{max.}	VDD,typ,TAMB = 25 °C, RH = 60 %	169.475	MHz
Line of Sight Range		Two-ray ground-reflection model	3000	m
Line of Sight Conditions: Antenna Height			2	m
RF Bitrate max.	R _{b, max.}	latest FW revision	25	kbps
Supply Current Transmitting	I _{TX}	VDD,typ,TAMB = 25 °C, RH = 60 %	59	mA
Supply Current Receiving	I _{RX}	VDD,typ,TAMB = 25 °C, RH = 60 %	28	mA
Output Power 50 Ohm	P _{0.50 Ω}	TAMB = 25 °C, RH = 60 %	15	dBm
RX sensitivity max.	R _{X_sens.}	50 Ω	-120	dBm
RX sensitivity Condition Bitrate	R _{X_sens, kbps}	latest FW revision	1.2	kbps

Product Specific Pinning:

Pin	Pad	Description	I/O
ANT	1	External antenna connection	--
GND	2	Negative supply voltage	Supply
VCC	3	Positive supply voltage	Supply
UTXD	4	UART transmit	Output
URXD	5	UART receive	Input
/RTS	6	Ready to send signal	Output
/CTS	7	Clear to send signal	Input
/DATA_IND	8	see manual for more details	Output
RESERVED	9	see manual for more details	--
RESERVED	10	see manual for more details	--
/DATA_REQ	11	see manual for more details	Input
RESERVED	12	see manual for more details	--
RESERVED	13	see manual for more details	--
TRX_DISABLE	14	see manual for more details	Input

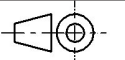
CHECKED	REVISION	DATE (YYYY-MM-DD)	GENERAL TOLERANCE	PROJECTION METHOD	
GE	002.000	2019-08-01	DIN ISO 2768-1m		
DESCRIPTION					
WIRL-PRO1 Radio module 169MHz					
ORDER CODE					
2607011111000					
BUSINESS UNIT			STATUS	PAGE	
eiSmart			Valid	2/6	



Würth Elektronik eiSos GmbH & Co. KG
EMC & Inductive Solutions
Max-Eyth-Str. 1
74638 Waldenburg
Germany
Tel. +49 (0) 79 42 945 - 0
www.we-online.com
eiSos@we-online.com

/CONFIG	15	see manual for more details	Input
RESERVED	16	see manual for more details	--
RESERVED	17	see manual for more details	--
RESERVED	18	see manual for more details	--
/RESET	19	Reset-Input	Input
RX_IND	20	Radio activity indicator for reception	Output
TX_IND	21	Radio activity indicator for transmission	Output
RESERVED	22	see manual for more details	--
GND	23	Negative supply voltage	Supply

		CHECKED GE	REVISION 002.000	DATE (YYYY-MM-DD) 2019-08-01	GENERAL TOLERANCE DIN ISO 2768-1m	PROJECTION METHOD 
		DESCRIPTION WIRL-PR01 Radio module 169MHz				ORDER CODE 2607011111000
		Würth Elektronik eiSos GmbH & Co. KG EMC & Inductive Solutions Max-Eyth-Str. 1 74638 Waldenburg Germany Tel. +49 (0) 79 42 945 - 0 www.we-online.com eiSos@we-online.com				BUSINESS UNIT eiSmart STATUS Valid PAGE 3/6

Packaging Specification - Tape and Reel: [mm]

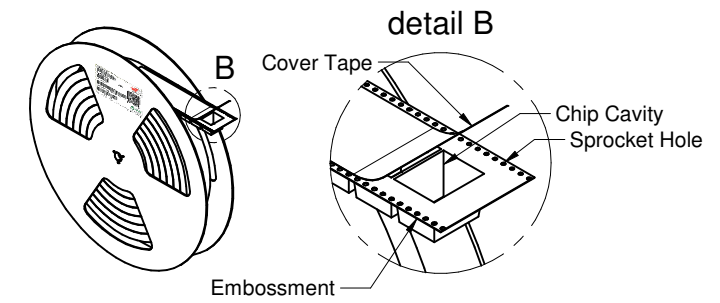
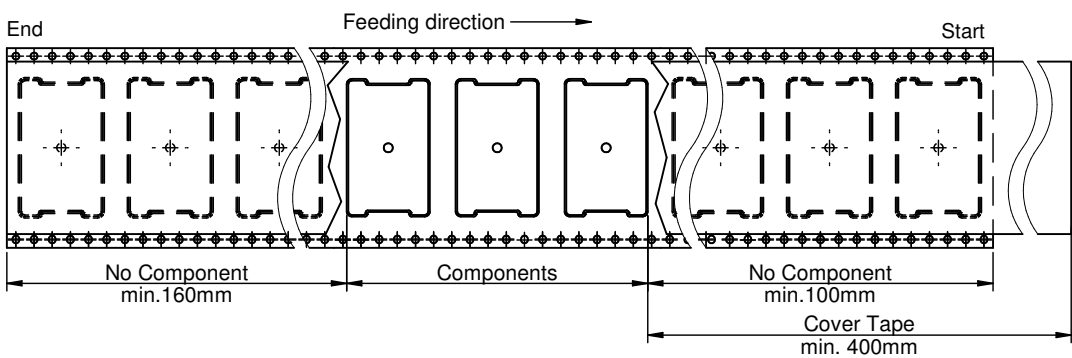
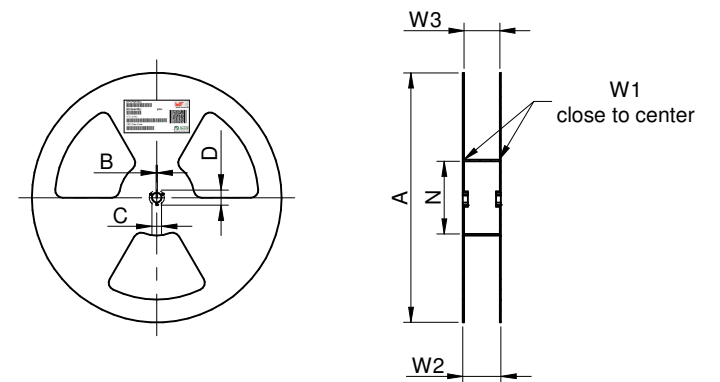
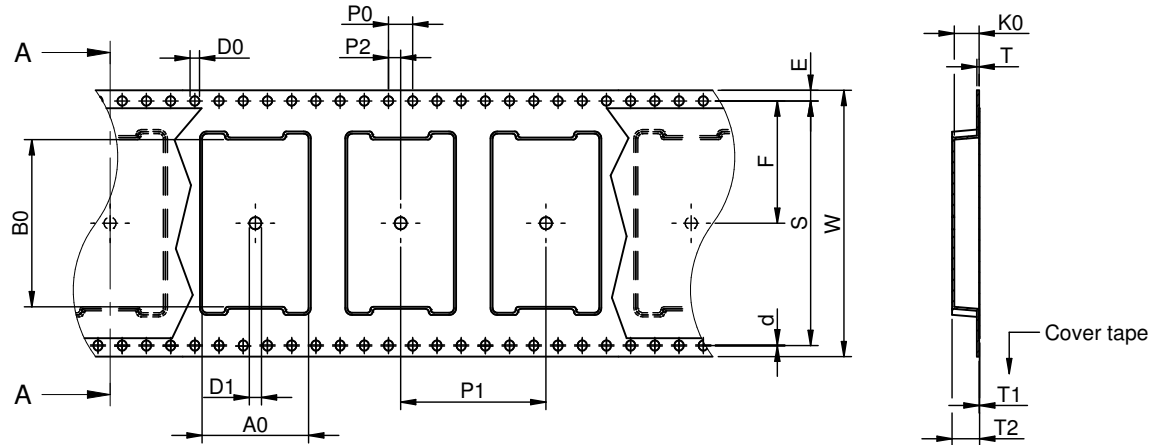

Packaging is referred to the international standard IEC 60286-3:2013

Tape Type	A0 (mm)	B0 (mm)	W (mm)	T (mm)	T1 (mm)	T2 (mm)	K0 (mm)	P0 (mm)	P1 (mm)	P2 (mm)	D0 (mm)	D0 / 2 (mm)	D1 (mm)	d (mm)	E (mm)	S (mm)	F (mm)	Material	Qty. (pcs.)
	typ.	typ.	±0,3	ref.	max.	typ.	typ.	±0,1	±0,1	±0,15	+0,1/ -0,0	+0,05/ -0,0	min.	±0,05	±0,1	±0,1	±0,1	Polystyrene	400
3	17,60	27,60	44,00	0,35	0,10	4,55	4,10	4,00	24,00	2,00	1,50	0,75	2,00	0,20	1,75	40,40	20,20	Polystyrene	400

A (mm)	B (mm)	C (mm)	D (mm)	N (mm)	W1 (mm)	W2 (mm)	W3 (mm)	W3 (mm)	Material
± 2,0	min.	min.	min.	min.	+ 2,0	max.	min.	max.	Polystyrene/ Polyurethane
330,00	1,50	12,80	20,20	80,00	44,40	50,40	43,90	47,40	

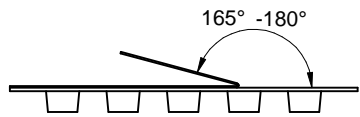

Tape width	44 mm	Pull-of force	0,1 N - 1,3 N
------------	-------	---------------	---------------

WÜRTH ELEKTRONIK

Würth Elektronik eiSos GmbH & Co. KG
 EMC & Inductive Solutions
 Max-Eyth-Str. 1
 74638 Waldenburg
 Germany
 Tel. +49 (0) 79 42 945 - 0
 www.we-online.com
 eiSos@we-online.com

CHECKED GE	REVISION 002.000	DATE (YYYY-MM-DD) 2019-08-01	GENERAL TOLERANCE DIN ISO 2768-1m	PROJECTION METHOD
DESCRIPTION WIRL-PR01 Radio module 169MHz			ORDER CODE 2607011111000	
BUSINESS UNIT eiSmart		STATUS Valid		PAGE 4/6

This electronic component has been designed and developed for usage in general electronic equipment only. This product is not authorized for use in equipment where a higher safety standard and reliability standard is especially required or where a failure of the product is reasonably expected to cause severe personal injury or death, unless the parties have executed an agreement specifically governing such use. Moreover Würth Elektronik eiSos GmbH & Co KG products are neither designed nor intended for use in areas such as military, aerospace, aviation, nuclear control, submarine, transportation (automotive control, train control, ship control), transportation signal, disaster prevention, medical, public information network etc. Würth Elektronik eiSos GmbH & Co KG must be informed about the intent of such usage before the design-in stage. In addition, sufficient reliability evaluation checks for safety must be performed on every electronic component which is used in electrical circuits that require high safety and reliability functions or performance.

Cautions and Warnings:

The following conditions apply to all goods within the product series of wireless connectivity of Würth Elektronik eiSos GmbH & Co. KG:

General:

- This electronic component is designed and developed with the intention for use in general electronic equipment.
- Würth Elektronik must be asked for written approval (following the PPAP procedure) before incorporating the components into any equipment in fields such as military, aerospace, aviation, nuclear control, submarine, transportation (automotive control, train control, ship control), transportation signal, disaster prevention, medical, public information network, etc. where higher safety and reliability are especially required and/or if there is the possibility of direct damage or human injury.
- Electronic components that will be used in safety-critical or high-reliability applications, should be pre-evaluated by the customer.
- The component is designed and manufactured to be used within the datasheet specified values. If the usage and operation conditions specified in the datasheet are not met, the wire insulation may be damaged or dissolved.
- Do not drop or impact the components, the component may be damaged.
- Würth Elektronik products are qualified according to international standards, which are listed in each product reliability report. Würth Elektronik does not guarantee any customer qualified product characteristics beyond Würth Elektronik's specifications, for its validity and sustainability over time.
- The customer is responsible for the functionality of their own products. All technical specifications for standard products also apply to customer specific products.

Product specific:

Soldering:

- The solder profile must comply with the technical product specifications. All other profiles will void the warranty.
- All other soldering methods are at the customer's own risk.

Cleaning and Washing:

- Washing agents used during the production to clean the customer application might damage or change the characteristics of the component. Washing agents may have a negative effect on the long-term functionality of the product.
- Using a brush during the cleaning process could break the module. Therefore, we do not recommend using a brush during the PCB cleaning process.

Potting and Coating:

- If the product is potted in the customer application, the potting material might shrink or expand during and after hardening. Shrinking could lead to an incomplete seal, allowing contaminants into the component. Expansion could damage the components. We recommend a manual inspection after potting to avoid these effects.

- Conformal coating may affect the product performance.

Storage Conditions:

- A storage of Würth Elektronik products for longer than 12 months is not recommended. Within other effects, the terminals may suffer degradation, resulting in bad solderability. Therefore, all products shall be used within the period of 12 months based on the day of shipment.
- Do not expose the components to direct sunlight.
- The storage conditions in the original packaging are defined according to DIN EN 61760-2.
- If there is a moisture sensitive component, the storage condition in the original packaging is defined according to IPC/JEDEC-J-STD-033. It is also recommended to return the component to the original moisture proof bag and reseal the moisture proof bag again.
- ESD prevention methods need to be followed for manual handling and processing by machinery.

Handling:

- Violation of the technical product specifications such as exceeding the nominal rated current, will void the warranty.
- Violation of the technical product specifications such as but not limited to exceeding the absolute maximum ratings will void the conformance to regulatory requirements.
- The Edge castellation is designed and made for prototyping, i.e. hand soldering purposes only.
- Non-antenna modules must be equipped with a proper antenna having specific characteristics.
- The applicable country regulations and specific environmental regulations must be observed.
- Do not disassemble the product. Evidence of tampering will void the warranty.

These cautions and warnings comply with the state of the scientific and technical knowledge and are believed to be accurate and reliable. However, no responsibility is assumed for inaccuracies or incompleteness.

All topics are described in a more detailed manner in the manual for each product.

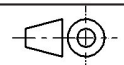
	CHECKED GE	REVISION 002.000	DATE (YYYY-MM-DD) 2019-08-01	GENERAL TOLERANCE DIN ISO 2768-1m	PROJECTION METHOD 
	DESCRIPTION WIRL-PR01 Radio module 169MHz				ORDER CODE 2607011111000
	Würth Elektronik eiSos GmbH & Co. KG EMC & Inductive Solutions Max-Eyth-Str. 1 74638 Waldenburg Germany Tel. +49 (0) 79 42 945 - 0 www.we-online.com eiSos@we-online.com			BUSINESS UNIT eiSmart	STATUS Valid

Important Notes

The following conditions apply to all goods within the product range of Würth Elektronik eiSos GmbH & Co. KG:

1. General Customer Responsibility

Some goods within the product range of Würth Elektronik eiSos GmbH & Co. KG contain statements regarding general suitability for certain application areas. These statements about suitability are based on our knowledge and experience of typical requirements concerning the areas, serve as general guidance and cannot be estimated as binding statements about the suitability for a customer application. The responsibility for the applicability and use in a particular customer design is always solely within the authority of the customer. Due to this fact it is up to the customer to evaluate, where appropriate to investigate and decide whether the device with the specific product characteristics described in the product specification is valid and suitable for the respective customer application or not.

2. Customer Responsibility related to Specific, in particular Safety-Relevant Applications

It has to be clearly pointed out that the possibility of a malfunction of electronic components or failure before the end of the usual lifetime cannot be completely eliminated in the current state of the art, even if the products are operated within the range of the specifications. In certain customer applications requiring a very high level of safety and especially in customer applications in which the malfunction or failure of an electronic component could endanger human life or health it must be ensured by most advanced technological aid of suitable design of the customer application that no injury or damage is caused to third parties in the event of malfunction or failure of an electronic component. Therefore, customer is cautioned to verify that data sheets are current before placing orders. The current data sheets can be downloaded at www.we-online.com.

3. Best Care and Attention

Any product-specific notes, cautions and warnings must be strictly observed. Any disregard will result in the loss of warranty.

4. Customer Support for Product Specifications

Some products within the product range may contain substances which are subject to restrictions in certain jurisdictions in order to serve specific technical requirements. Necessary information is available on request. In this case the field sales engineer or the internal sales person in charge should be contacted who will be happy to support in this matter.

5. Product R&D

Due to constant product improvement product specifications may change from time to time. As a standard reporting procedure of the Product Change Notification (PCN) according to the JEDEC-Standard inform about minor and major changes. In case of further queries regarding the PCN, the field sales engineer or the internal sales person in charge should be contacted. The basic responsibility of the customer as per Section 1 and 2 remains unaffected.

6. Product Life Cycle

Due to technical progress and economical evaluation we also reserve the right to discontinue production and delivery of products. As a standard reporting procedure of the Product Termination Notification (PTN) according to the JEDEC-Standard we will inform at an early stage about inevitable product discontinuance. According to this we cannot guarantee that all products within our product range will always be available. Therefore it needs to be verified with the field sales engineer or the internal sales person in charge about the current product availability expectancy before or when the product for application design-in disposal is considered. The approach named above does not apply in the case of individual agreements deviating from the foregoing for customer-specific products.

7. Property Rights

All the rights for contractual products produced by Würth Elektronik eiSos GmbH & Co. KG on the basis of ideas, development contracts as well as models or templates that are subject to copyright, patent or commercial protection supplied to the customer will remain with Würth Elektronik eiSos GmbH & Co. KG. Würth Elektronik eiSos GmbH & Co. KG does not warrant or represent that any license, either expressed or implied, is granted under any patent right, copyright, mask work right, or other intellectual property right relating to any combination, application, or process in which Würth Elektronik eiSos GmbH & Co. KG components or services are used.

8. General Terms and Conditions

Unless otherwise agreed in individual contracts, all orders are subject to the current version of the "General Terms and Conditions of Würth Elektronik eiSos Group", last version available at www.we-online.com.

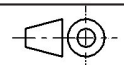
	Würth Elektronik eiSos GmbH & Co. KG EMC & Inductive Solutions Max-Eyth-Str. 1 74638 Waldenburg Germany Tel. +49 (0) 79 42 945 - 0 www.we-online.com eiSos@we-online.com	CHECKED	REVISION	DATE (YYYY-MM-DD)	GENERAL TOLERANCE	PROJECTION METHOD	
		GE	002.000	2019-08-01	DIN ISO 2768-1m		
		DESCRIPTION					
WIRL-PRO1 Radio module 169MHz						2607011111000	
					BUSINESS UNIT	STATUS	PAGE
					eiSmart	Valid	6/6