

OSFP-400G-PDAC2M-C

MSA and TAA Compliant 400GBase-CU OSFP to OSFP Direct Attach Cable (Passive Twinax, 2m)

Features

- OSFP MSA compliant
- 8 parallel full-duplex channels
- Compliant to IEEE802.3cd and SFF-8417
- Pluggable/Direct Attach
- Wire Gauge: 30 AWG
- Shielded Cable Assembly
- High-Speed Cable Assembly
- 32 Signal Positions
- Data Rate 56Gbps per channel
- RoHS compliant



Applications

- 400G Ethernet

Product Description

This is an MSA compliant 400GBase-CU OSFP to OSFP direct attach cable that operates over passive copper with a maximum reach of 2.0m (6.6ft). It has been programmed, uniquely serialized, and data-traffic and application tested to ensure it is 100% compliant and functional. This direct attach cable is TAA (Trade Agreements Act) compliant, and is built to comply with MSA (Multi-Source Agreement) standards. We stand behind the quality of our products and proudly offer a limited lifetime warranty.

ProLabs' direct attach cables are RoHS compliant and lead-free.

TAA refers to the Trade Agreements Act (19 U.S.C. & 2501-2581), which is intended to foster fair and open international trade. TAA requires that the U.S. Government may acquire only "U.S. – made or designated country end products."



Regulatory Compliance

- RoHS Compliant to EU RoHS Directive 2011/65/EU
- EU REACH Regulation (EC) No. 1907/2006: Current ECHA Candidate List JUL 2021 (219)
- Halogen Content: Not Low Halogen – contains Br or Cl > 900ppm
- Pluggable I/O Cable Assembly Flammability Rating: VW-1
- All materials, components and processes comply with TEC-138-702

General Characteristics

Parameter	Specification
Product Type Features	
Data Rate	56Gb/s
Cable Assembly Category	High Speed
Pluggable I/O Cable Assembly Type	Pluggable/Direct Attach
Pluggable I/O Cable Assembly Shielded	Yes
Cable Assembly Connector Type	OSFP (2)
Pluggable I/O Cable Assembly Cable	Round Jacketed Twinax
Assembly Color	Black
Cable Assembly Length	2m (6.6ft)
Configuration Features	
Configuration	Double-Ended
Number of Pluggable I/O Cable Assembly Positions	8-Pair
Number of Signal Positions	32
Electrical Characteristics	
Impedance	100 Ω
Voltage	3.8 VDC (max)
Current	Signal Application Only
Temperature	-10 to 60°C
Dimensions	
Wire Gauge	30 AWG
Body Features	
Jacket Material	PVC

Pin Descriptions

Pin #	Symbol	Description	Logic	Direction	Plug Sequence
1	GND		Ground		1
2	TX2p	Transmitter Data Non-Inverted	CML-I	Input from Host	3
3	TX2n	Transmitter Data Inverted	CML-I	Input from Host	3
4	GND		Ground		1
5	TX4p	Transmitter Data Non-Inverted	CML-I	Input from Host	3
6	TX4n	Transmitter Data Inverted	CML-I	Input from Host	3
7	GND		Ground		1
8	TX6p	Transmitter Data Non-Inverted	CML-I	Input from Host	3
9	TX6n	Transmitter Data Inverted	CML-I	Input from Host	3
10	GND		Ground		1
11	TX8p	Transmitter Data Non-Inverted	CML-I	Input from Host	3
12	TX8n	Transmitter Data Inverted	CML-I	Input from Host	3
13	GND		Ground		1
14	SCL	2-wire Serial interface clock	LVC MOS-I/O	Bi-directional	3
15	VCC	+3.3V Power		Power from Host	2
16	VCC	+3.3V Power		Power from Host	2
17	LPWn/PRSn	Low-Power Mode / Module Present	Multi-Level	Bi-directional	3
18	GND		Ground		1
19	RX7n	Receiver Data Inverted	CML-O	Output to Host	3
20	RX7p	Receiver Data Non-Inverted	CML-O	Output to Host	3
21	GND		Ground		1
22	RX5n	Receiver Data Inverted	CML-O	Output to Host	3
23	RX5p	Receiver Data Non-Inverted	CML-O	Output to Host	3
24	GND		Ground		1
25	RX3n	Receiver Data Inverted	CML-O	Output to Host	3
26	RX3p	Receiver Data Non-Inverted	CML-O	Output to Host	3
27	GND		Ground		1
28	RX1n	Receiver Data Inverted	CML-O	Output to Host	3
29	RX1p	Receiver Data Non-Inverted	CML-O	Output to Host	3
30	GND		Ground		1
31	GND		Ground		1
32	RX2p	Receiver Data Non-Inverted	CML-O	Output to Host	3
33	RX2n	Receiver Data Inverted	CML-O	Output to Host	3
34	GND		Ground		1
35	RX4p	Receiver Data Non-Inverted	CML-O	Output to Host	3
36	RX4n	Receiver Data Inverted	CML-O	Output to Host	3
37	GND		Ground		1
38	RX6p	Receiver Data Non-Inverted	CML-O	Output to Host	3

Pin #	Symbol	Description	Logic	Direction	Plug Sequence
39	RX6n	Receiver Data Inverted	CML-O	Output to Host	3
40	GND		Ground		1
41	RX8p	Receiver Data Non-Inverted	CML-O	Output to Host	3
42	RX8n	Receiver Data Inverted	CML-O	Output to Host	3
43	GND		Ground		1
44	INT/RSTn	Module Interrupt / Module Reset	Multi-Level	Bi-directional	3
45	VCC	+3.3V Power		Power from Host	2
46	VCC	+3.3V Power		Power from Host	2
47	SDA	2-wire Serial interface data	LVC MOS-I/O	Bi-directional	3
48	GND		Ground		1
49	TX7n	Transmitter Data Inverted	CML-I	Input from Host	3
50	TX7p	Transmitter Data Non-Inverted	CML-I	Input from Host	3
51	GND		Ground		1
52	TX5n	Transmitter Data Inverted	CML-I	Input from Host	3
53	TX5p	Transmitter Data Non-Inverted	CML-I	Input from Host	3
54	GND		Ground		1
55	TX3n	Transmitter Data Inverted	CML-I	Input from Host	3
56	TX3p	Transmitter Data Non-Inverted	CML-I	Input from Host	3
57	GND		Ground		1
58	TX1n	Transmitter Data Inverted	CML-I	Input from Host	3
59	TX1p	Transmitter Data Non-Inverted	CML-I	Input from Host	3
60	GND		Ground		1

Electrical Pin-out Assignment

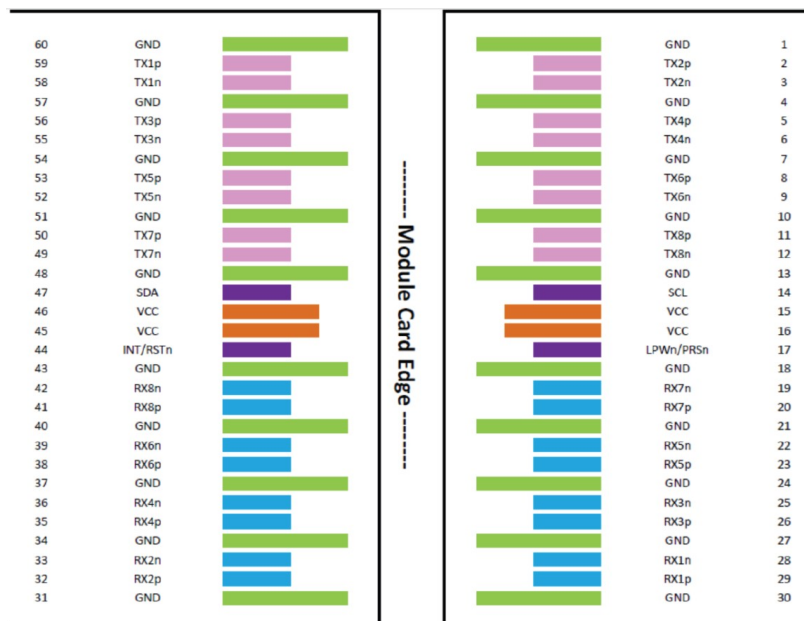

Wiring Pattern

P1			P2	
GND	1		31	GND
TX2+	2	↔	32	RX2+
TX2-	3	↔	33	RX2-
GND	4		34	GND
TX4+	5	↔	35	RX4+
TX4-	6	↔	36	RX4-
GND	7		37	GND
TX6+	8	↔	38	RX6+
TX6-	9	↔	39	RX6-
GND	10		40	GND
TX8+	11	↔	41	RX8+
TX8-	12	↔	42	RX8-
GND	13		43	GND
SCL	14		44	INT_L/RESET_L
VCC	15		45	VCC
VCC	16		46	VCC
PRSNT_L	17		47	SDA
GND	18		48	GND
RX7-	19	↔	49	TX7-
RX7+	20	↔	50	TX7+
GND	21		51	GND
RX5-	22	↔	52	TX5-
RX5+	23	↔	53	TX5+
GND	24		54	GND
RX3-	25	↔	55	TX3-
RX3+	26	↔	56	TX3+
GND	27		57	GND
RX1-	28	↔	58	TX1-
RX1+	29	↔	59	TX1+
GND	30		60	GND

P1			P2	
GND	31		1	GND
RX2+	32	↔	2	TX2+
RX2-	33	↔	3	TX2-
GND	34		4	GND
RX4+	35	↔	5	TX4+
RX4-	36	↔	6	TX4-
GND	37		7	GND
RX6+	38	↔	8	TX6+
RX6-	39	↔	9	TX6-
GND	40		10	GND
RX8+	41	↔	11	TX8+
RX8-	42	↔	12	TX8-
GND	43		13	GND
INT_L/RESET_L	44		14	SCL
VCC	45		15	VCC
VCC	46		16	VCC
SDA	47		17	PRSNT_L
GND	48		18	GND
TX7-	49	↔	19	RX7-
TX7+	50	↔	20	RX7+
GND	51		21	GND
TX5-	52	↔	22	RX5-
TX5+	53	↔	23	RX5+
GND	54		24	GND
TX3-	55	↔	25	RX3-
TX3+	56	↔	26	RX3+
GND	57		27	GND
TX1-	58	↔	28	RX1-
TX1+	59	↔	29	RX1+
GND	60		30	GND

Mechanical Specifications

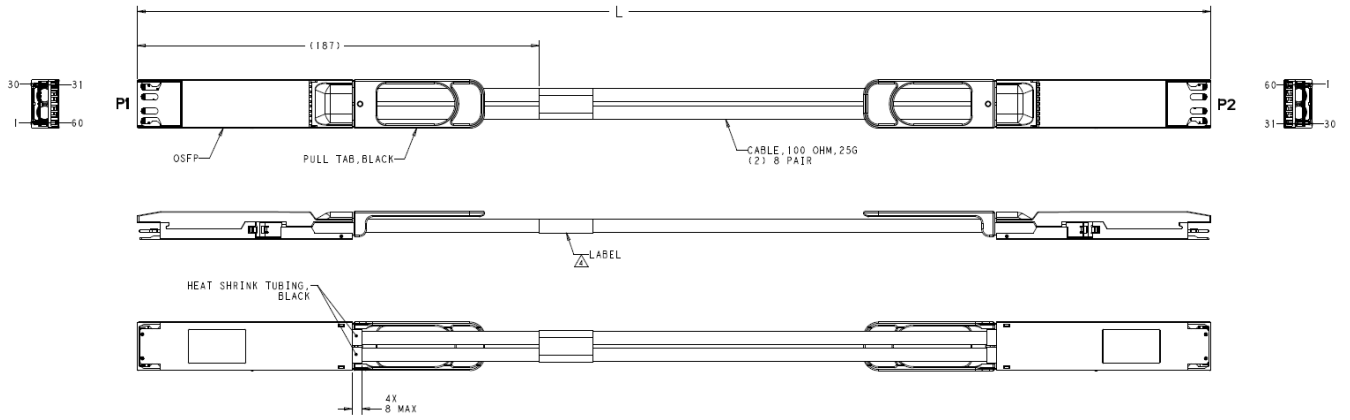

About ProLabs

Our experience comes as standard; for over 15 years ProLabs has delivered optical connectivity solutions that give our customers freedom and choice through our ability to provide seamless interoperability. At the heart of our company is the ability to provide state-of-the-art optical transport and connectivity solutions that are compatible with over 90 optical switching and transport platforms.

Complete Portfolio of Network Solutions

ProLabs is focused on innovations in optical transport and connectivity. The combination of our knowledge of optics and networking equipment enables ProLabs to be your single source for optical transport and connectivity solutions from 100Mb to 400G while providing innovative solutions that increase network efficiency. We provide the optical connectivity expertise that is compatible with and enhances your switching and transport equipment.

Trusted Partner

Customer service is our number one value. ProLabs has invested in people, labs and manufacturing capacity to ensure that you get immediate answers to your questions and compatible product when needed. With Engineering and Manufacturing offices in the U.K. and U.S. augmented by field offices throughout the U.S., U.K. and Asia, ProLabs is able to be our customers best advocate 24 hours a day.

Contact Information

ProLabs US

Email: sales@prolabs.com

Telephone: 952-852-0252

ProLabs UK

Email: salessupport@prolabs.com

Telephone: +44 1285 719 600