

## High Power LED Series 3535 Ceramic Hot Binning

# LH351C

For High TLCI

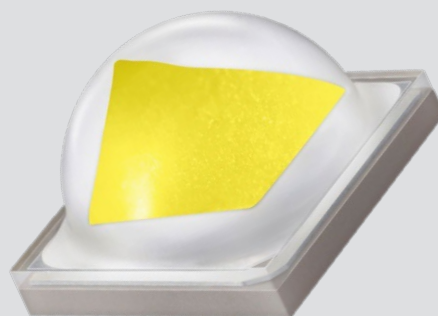

High efficacy and high quality color rendering makes the LH351C suitable use in a broad range of applications

### Features & Benefits

- Operates at a maximum current of up to 2 A
- Uniform light distribution under any beam angle
- 90 CRI makes it well suited for most applications
- Hot binning @ 85 °C

### Applications

- Indoor Lighting: Spotlight, Downlight
- Outdoor Lighting: Street Light, Tunnel Light, Security Light, Area Light, Stadium/Arena Light
- Industrial Lighting: High Bay Light, Low Bay Light
- Consumer Lighting: Torch Light



## Table of Contents

1.	Characteristics	-----	3
2.	Product Code Information	-----	6
3.	Typical Characteristics Graphs	-----	9
4.	Outline Drawing & Dimension	-----	11
5.	Reliability Test Items & Conditions	-----	12
6.	Soldering Conditions	-----	13
7.	Tape & Reel	-----	14
8.	Label Structure	-----	16
9.	Packing Structure	-----	17
10.	Precautions in Handling & Use	-----	19

## 1. Characteristics

### a) Absolute Maximum Rating

Item	Symbol	Rating	Unit	Condition
Operating Temperature	$T_{opr}$	-40 ~ +105	°C	Note 1)*
Storage Temperature	$T_{stg}$	-40 ~ +120	°C	-
LED Junction Temperature	$T_j$	150	°C	-
Forward Current	$I_F$	2000	mA	-
Peak Pulse Forward Current	$I_{FP}$	2600	mA	Duty 1/10 pulse width 10ms
Assembly Process Temperature		260 <10	°C s	-
ESD (HBM)	-	±8	kV	-

#### Notes:

- 1) Refer to the derating curve, '3. Typical Characteristics Graph', for proper driving current that maintained below maximum junction temperature.

## b) Electro-optical Characteristics

Item	Unit	Nominal CCT (K)	Condition		Value Typ.
			I <sub>F</sub> (mA)	T <sub>J</sub> (°C)	
Luminous Flux (Φ <sub>v</sub> )	lm	4000 (70 CRI)	350	85	173
			700	25	355
			700	85	320
			1050	85	448
			1500	85	579
			2000	85	685
Forward Voltage (V <sub>F</sub> )	V		350	85	2.76
			700	25	3.01
			700	85	2.90
			1050	85	3.01
			1500	85	3.11
			2000	85	3.18
Reverse Voltage (@ 5 mA)	V		25		11~15
Thermal Resistance (junction to solder point)	°C/W		25		3
Beam Angle	°		700	25	128

**Notes:**

- 1) Samsung maintains measurement tolerance of: luminous flux = ±7 %, forward voltage = ±0.1 V
- 2) Characteristics @ 25 °C are for reference only

### c) Luminous Flux Characteristics (T<sub>j</sub> = 85 °C)

Sorting @ 700 mA (lm)			Calculated Minimum Flux <sup>2)</sup> (lm)				
Flux Rank	Flux Range <sup>1)</sup>	Sub Rank	@ 350 mA	@ 700 mA	@ 1050 mA	@ 1500 mA	@ 2000 mA
<i>KF</i>	230 ~ 290	<i>KB, MB, NB</i>	124	230	326	436	542

#### Notes:

- 1) Samsung maintains measurement tolerance of: luminous flux =  $\pm 7\%$ , CRI =  $\pm 3$
- 2) Calculated minimum flux values at 350/1050/1500/2000mA are for reference only.

## 2. Product Code Information

1	2	3	4	5	6	7	8	9	10	11	12	13	14	15	16	17	18
S	P	H	W	H	T	L	3	D	5	0	T	V	4	Q	T	K	F

Digit	PKG Information	Code	Specification									
1 2 3	Samsung Package High Power	<b>SPH</b>										
4 5	Color	<b>WH</b>	White									
6	Product Version	<b>T</b>										
7 8	Product	<b>L3</b>	LH351 Series									
9	Lens Type	<b>D</b>	Dome lens									
10	Internal Code	<b>5</b>	LH351C									
11	Not Defined	<b>0</b>	Default									
12	CRI & Sorting Temperature	<b>T</b>	Min. 90, For TLCI									
13 14	Forward Voltage (V)	<b>V 4</b>	<table> <tr> <td>2.5~3.1</td> <td>Bin Code:</td> <td><b>U2</b> 2.5~2.7</td> </tr> <tr> <td></td> <td></td> <td><b>V2</b> 2.7~2.9</td> </tr> <tr> <td></td> <td></td> <td><b>W2</b> 2.9~3.1</td> </tr> </table>	2.5~3.1	Bin Code:	<b>U2</b> 2.5~2.7			<b>V2</b> 2.7~2.9			<b>W2</b> 2.9~3.1
2.5~3.1	Bin Code:	<b>U2</b> 2.5~2.7										
		<b>V2</b> 2.7~2.9										
		<b>W2</b> 2.9~3.1										
15 16	CCT (K)	<b>Q T</b>	5700 Bin Code: Q1, Q2, Q3, Q4,									
17 18	Luminous Flux (lm)	<b>K F</b>	<table> <tr> <td>230 ~ 290</td> <td><b>KB</b></td> <td>230 ~ 250</td> </tr> <tr> <td></td> <td><b>MB</b></td> <td>250 ~ 270</td> </tr> <tr> <td></td> <td><b>NB</b></td> <td>270 ~ 290</td> </tr> </table> <p>Digit 17: Min. spec. Digit 18: The number of higher bin(s) from min. spec. e.g.: KB = 230~250 lm, KF = 230~290 lm</p>	230 ~ 290	<b>KB</b>	230 ~ 250		<b>MB</b>	250 ~ 270		<b>NB</b>	270 ~ 290
230 ~ 290	<b>KB</b>	230 ~ 250										
	<b>MB</b>	250 ~ 270										
	<b>NB</b>	270 ~ 290										

**a) Luminous Flux Bins ( $I_F = 700 \text{ mA}$ ,  $T_j = 85 \text{ }^\circ\text{C}$ )**

CRI/ Nominal CCT (K)	Flux rank											
	FB	GB	HB	JB	KB	MB	NB	PB	QB	RB	SB	TB
(min. flux)	150	170	190	210	230	250	270	290	310	330	350	370
90      5700	<b>SPHWHTL3D50TV4QTKF</b>											

**b) Color Bins ( $I_F = 700 \text{ mA}$ ,  $T_j = 85 \text{ }^\circ\text{C}$ )**

Nominal CCT (K)	CRI ( $R_a$ )	Color Rank	Chromaticity Bins
5700	90	QT	Q1, Q2, Q3, Q4

**c) Voltage Bins ( $I_F = 700 \text{ mA}$ ,  $T_j = 85 \text{ }^\circ\text{C}$ )**

Nominal CCT (K)	CRI ( $R_a$ ) Min.	Product Code	Voltage Rank	Voltage Bin	Voltage Range (V)
-	-	-	V4	U2	2.5 ~ 2.7
-	-	-		V2	2.7 ~ 2.9
-	-	-		W2	2.9 ~ 3.1

e) Chromaticity Region & Coordinates ( $I_F = 700 \text{ mA}$ ,  $T_j = 85 \text{ }^\circ\text{C}$ )

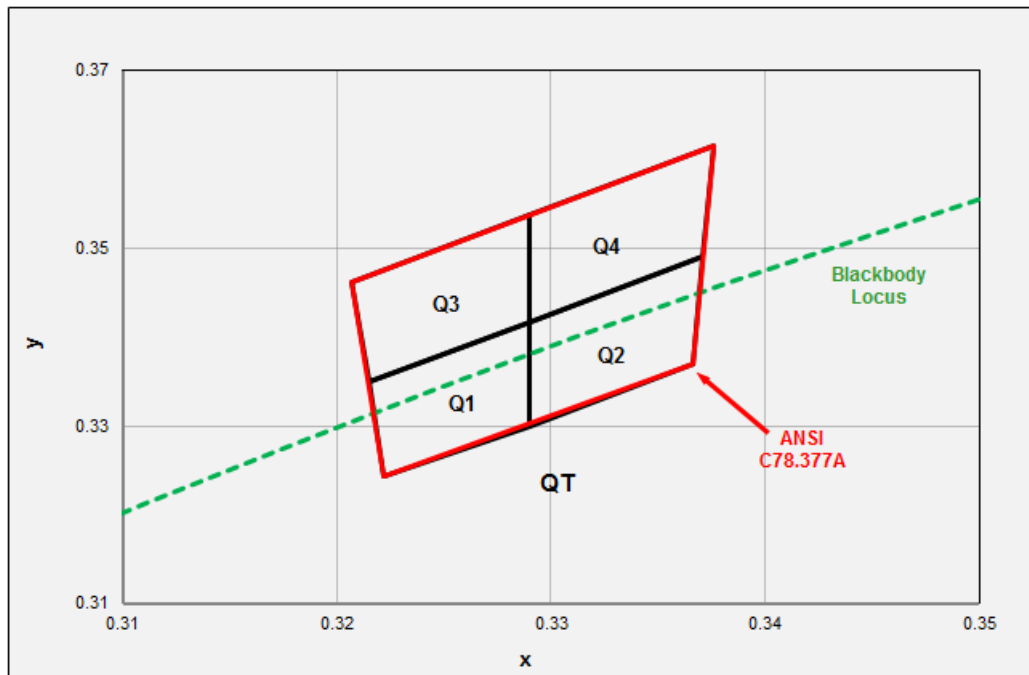

Region	CIE x	CIE y	Region	CIE x	CIE y
QT rank (5700 K)					
Q1	0.3215	0.3350	Q3	0.3207	0.3462
	0.3290	0.3417		0.3290	0.3538
	0.3290	0.3300		0.3290	0.3417
	0.3222	0.3243		0.3215	0.3350
Q2	0.3290	0.3417	Q4	0.3290	0.3538
	0.3371	0.3490		0.3376	0.3616
	0.3366	0.3369		0.3371	0.3490
	0.3290	0.3300		0.3290	0.3417

**Note:**

Samsung maintains measurement tolerance of:  $C_x, C_y = \pm 0.005$



### 3. Typical Characteristics Graphs

#### a) Spectrum Distribution ( $I_F = 700 \text{ mA}$ , $T_j = 85 \text{ }^\circ\text{C}$ )

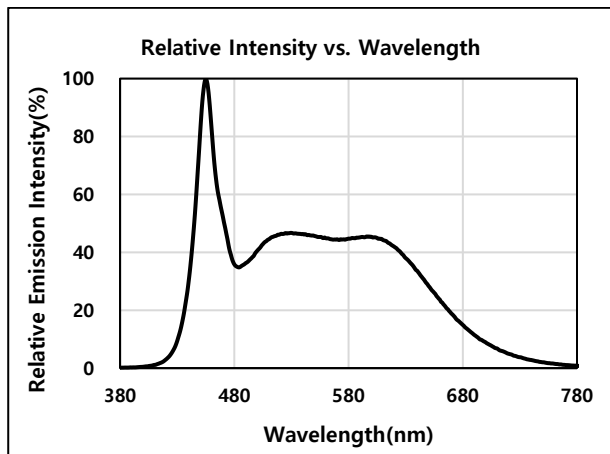

#### b) Forward Current Characteristics ( $T_j = 85 \text{ }^\circ\text{C}$ )

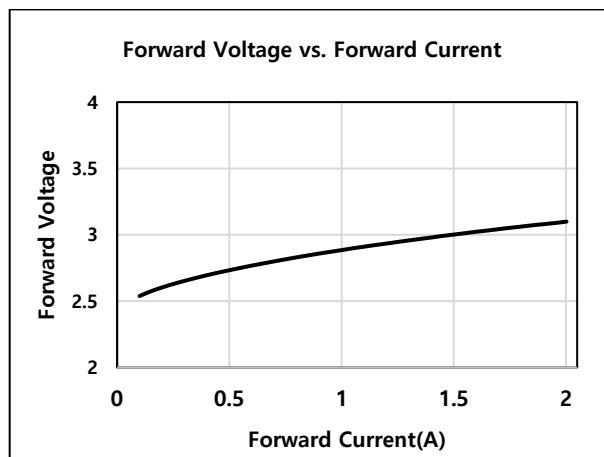
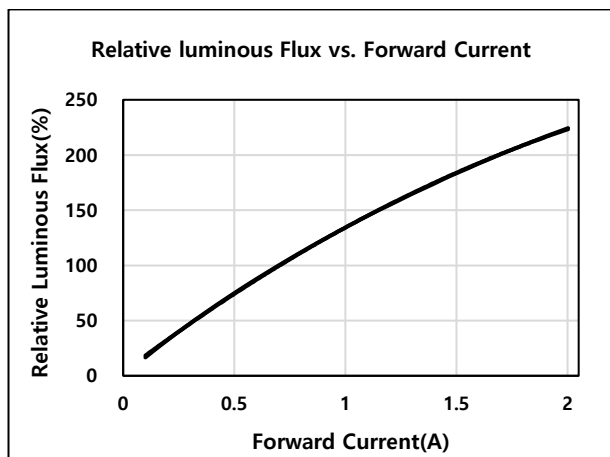

#### c) Temperature Characteristics ( $I_F = 700 \text{ mA}$ )

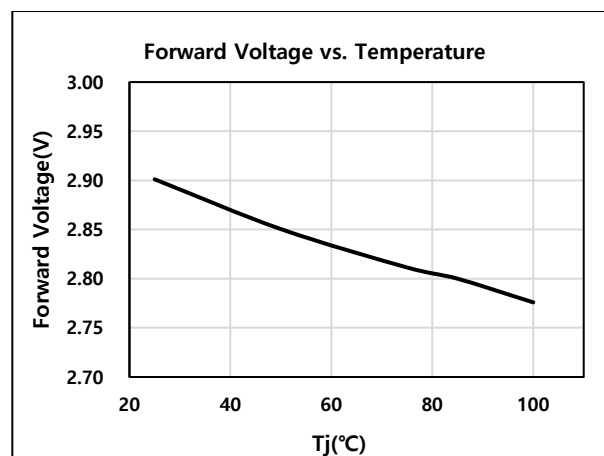
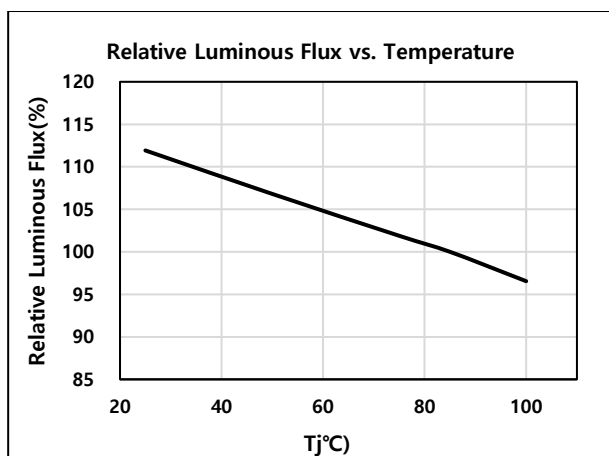

d) Color Shift Characteristics ( $I_F = 700 \text{ mA}$ ,  $T_j = 85 \text{ }^\circ\text{C}$ )

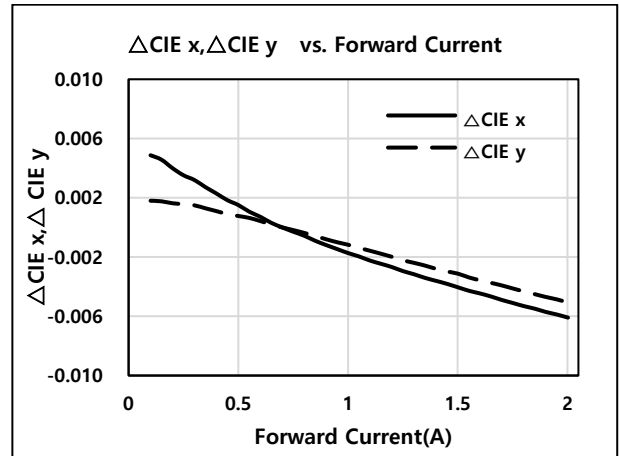
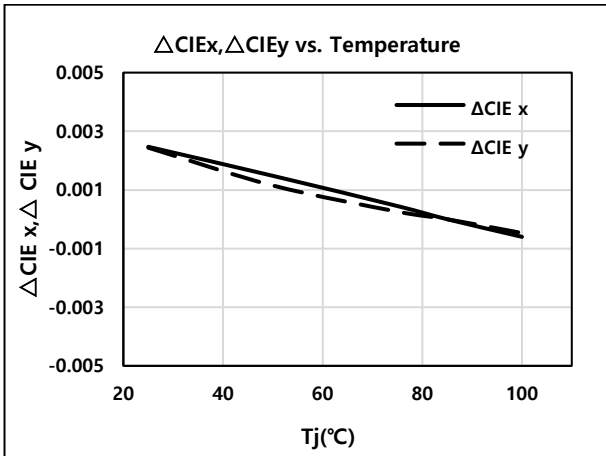

e) Derating Curve and Beam Angle Characteristics ( $I_F = 700 \text{ mA}$ ,  $T_j = 25 \text{ }^\circ\text{C}$ )

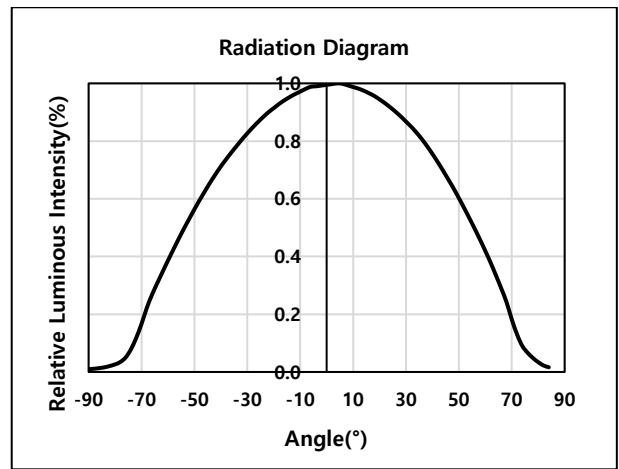
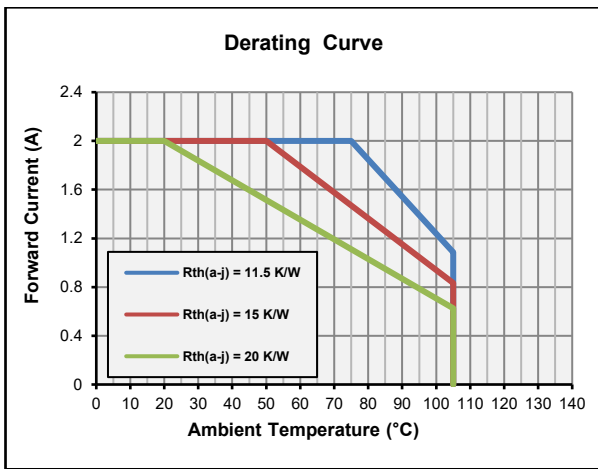

#### 4. Outline Drawing & Dimension

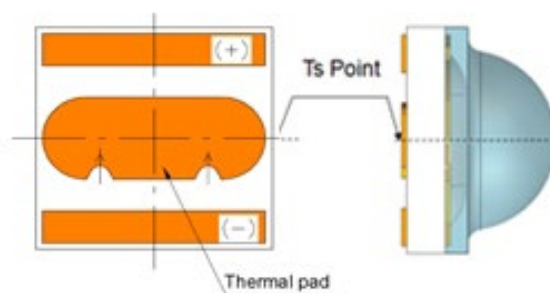
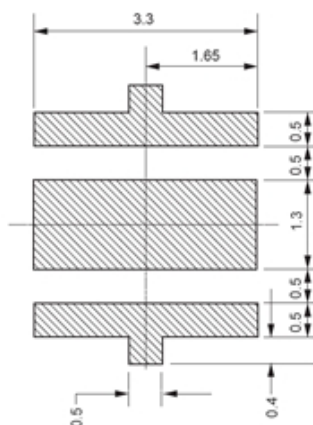
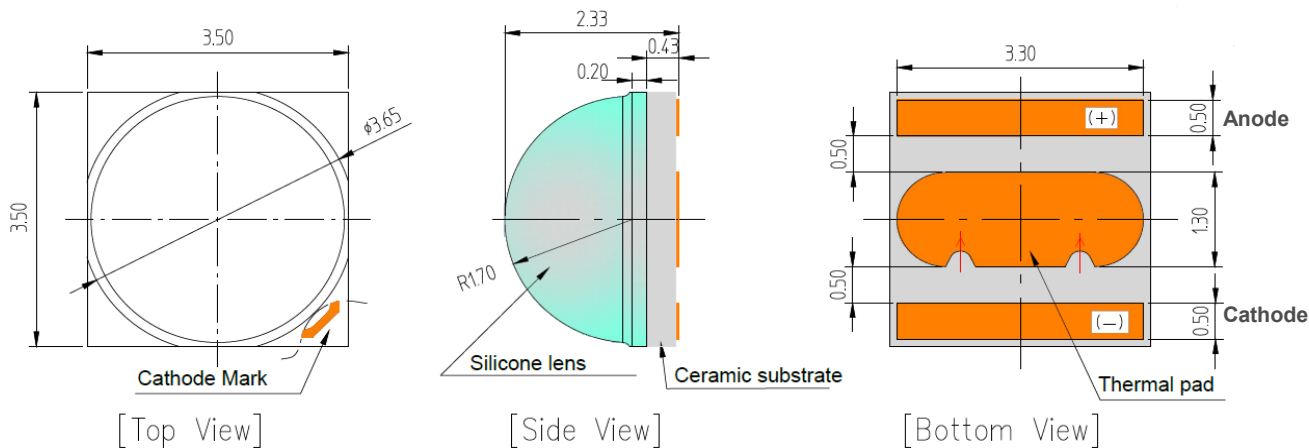

- Measurement unit: mm
- Tolerance:  $\pm 0.13$  mm

#### Recommended Soldering Pattern

##### Notes:

- 1) This LED has built-in ESD protection device(s) connected in parallel to LED chip(s).
- 2) The thermal pad is electrically isolated from the anode and cathode contact pads.
- 3)  $T_s$  point and measurement method:
  - ① Measure the nearest point to thermal pad as shown above. If necessary, remove PSR of PCB to reach  $T_s$  point.
  - ② All pads must be soldered to the PCB to dissipate heat properly, otherwise the LED can be damaged.

##### Precautions:

- 1) Pressure on the LEDs will influence to the reliability of the LEDs. Precautions should be taken to avoid strong pressure on the LEDs. Do not put stress on the LEDs during heating.
- 2) Re-soldering should not be done after the LEDs have been soldered. If re-soldering is unavoidable, LED's characteristics should be carefully checked before and after such repair.
- 3) Do not stack assembled PCBs together. Since materials of LEDs is soft, abrasion between two PCB assembled with LED might cause catastrophic failure of the LEDs.

## 5. Reliability Test Items & Conditions

### a) Test Items

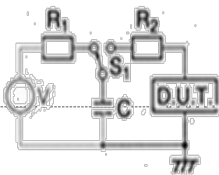
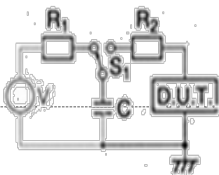
Test Item	Test Condition	Test Hour / Cycle
Room Temperature Life Test	25 °C, Maximum Rated Drive Current	1000 h
High Temperature Life Test	85 °C, Maximum Rated Drive Current	1000 h
High Temperature Humidity Life Test	85 °C, 85 % RH, Maximum Rated Drive Current	1000 h
Low Temperature Life Test	-40 °C, Maximum Rated Drive Current	1000 h
Powered Temperature Cycle	-45 °C / 20 min ↔ 85 °C / 20 min, sweep 100 min cycle on/off: each 5 min, Maximum Rated Drive Current	100 cycles
Temperature Cycling	-45 °C / 15 min ↔ 125 °C / 15 min temperature change within 5 min	500 cycles
High Temperature Storage	120 °C	1000 h
Low Temperature Storage	-40 °C	1000 h
ESD (HBM)	 <p> <math>R_1</math>: 10 M<math>\Omega</math>  <math>R_2</math>: 1.5 k<math>\Omega</math>  <math>C</math>: 100 pF  <math>V</math>: <math>\pm 8</math> kV </p>	5 times
ESD (MM)	 <p> <math>R_1</math>: 10 M<math>\Omega</math>  <math>R_2</math>: 0  <math>C</math>: 200 pF  <math>V</math>: <math>\pm 0.8</math> kV </p>	5 times
Vibration Test	20~2000~20 Hz, 200 m/s <sup>2</sup> , sweep 4 min X, Y, Z 3 direction, each 1 cycle	4 cycles

### b) Criteria for Judging the Damage

Item	Symbol	Test Condition ( $T_J = 25$ °C)	Limit	
			Min.	Max.
Forward Voltage	$V_F$	$I_F = 700$ mA	Init. Value * 0.9	Init. Value * 1.1
Luminous Flux	$\Phi_v$	$I_F = 700$ mA	Init. Value * 0.7	Init. Value * 1.1

## 6. Soldering Conditions

### a) Reflow Conditions (Pb free)

Reflow frequency: 2 times max.

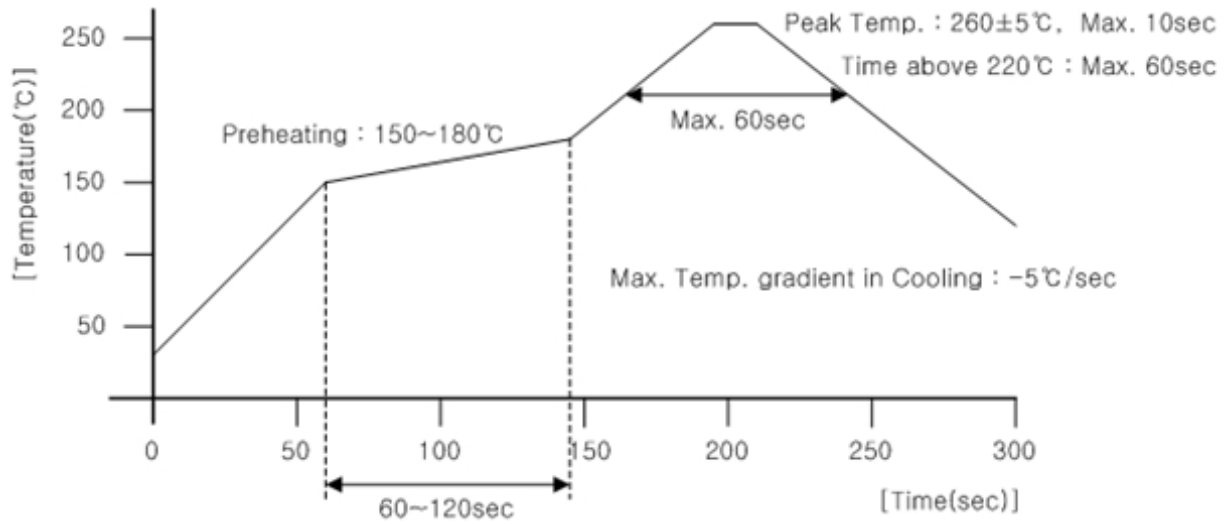

### b) Manual Soldering Conditions

Not more than 5 seconds @ max. 300 °C, under soldering iron.

7. Tape & Reel

a) Taping Dimension

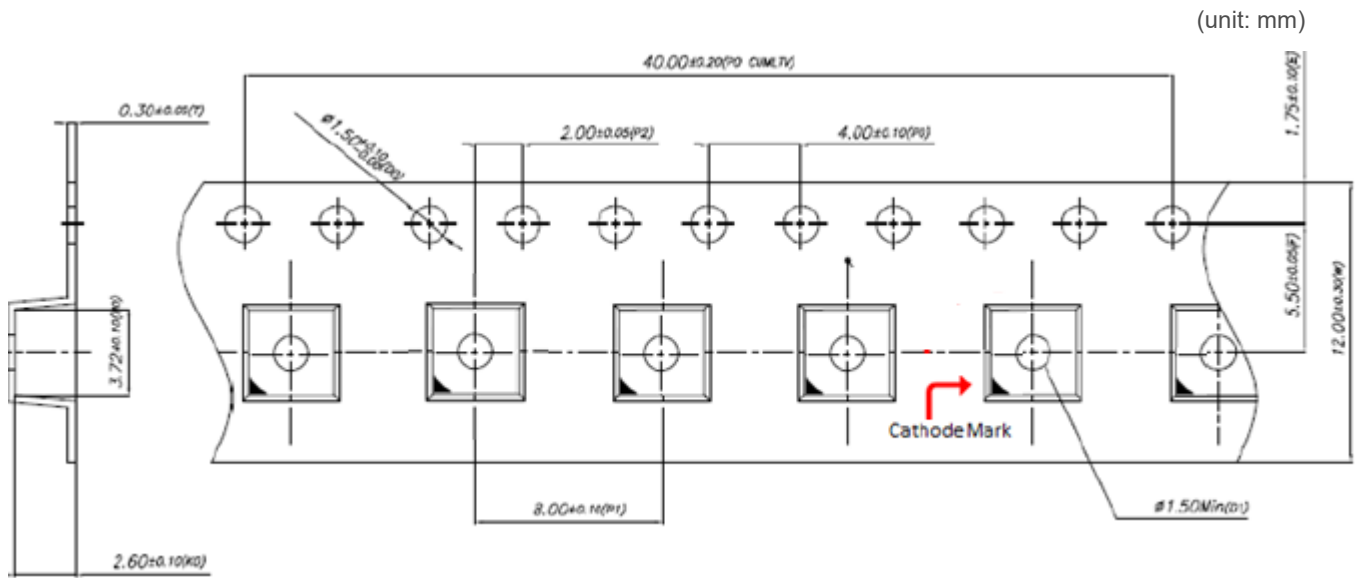

Taping Diretion

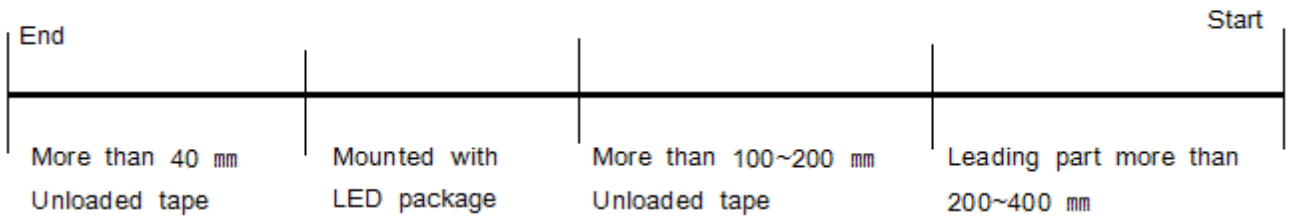

Taping Direction

## b) Reel Dimension

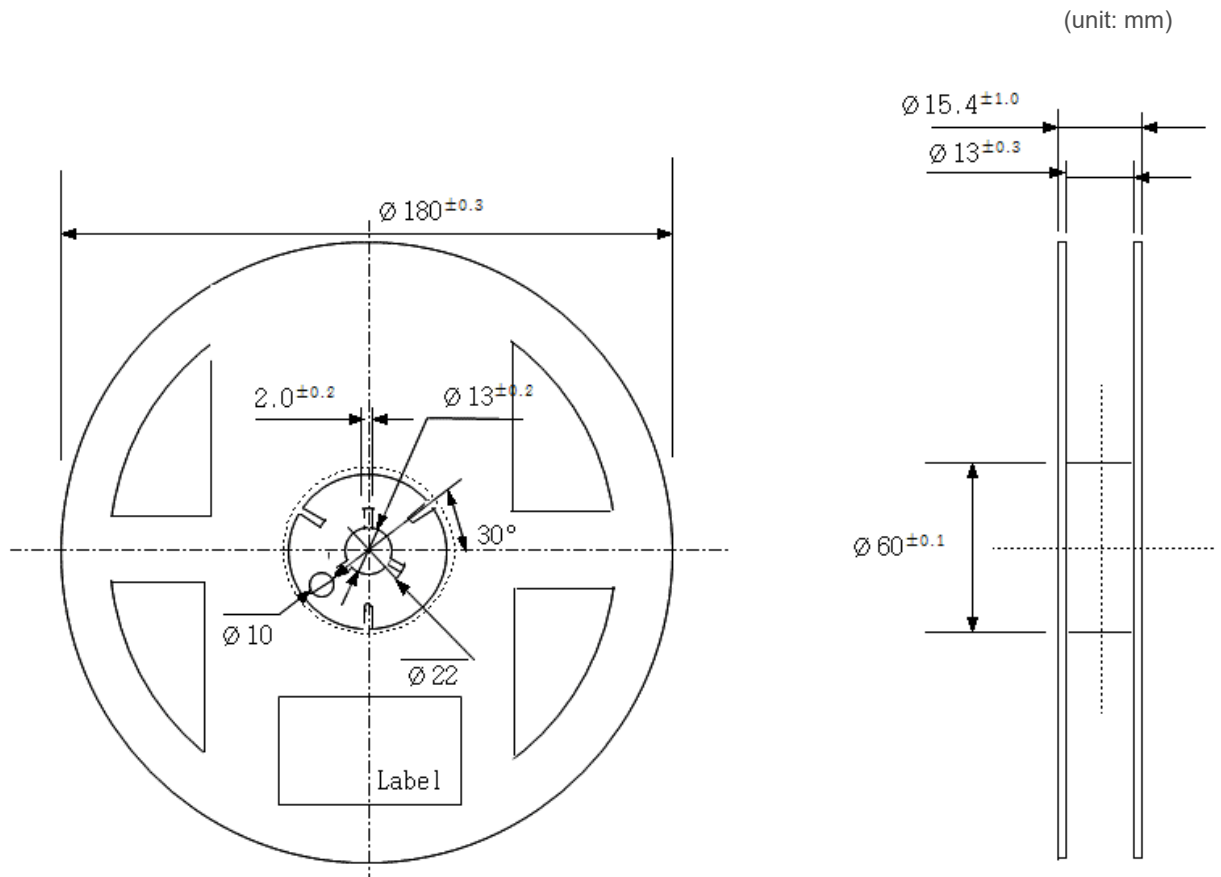
**Notes:**

- 1) Quantity: The quantity/reel is 800 pcs
- 2) Cumulative tolerance: Cumulative tolerance / 10 pitches is  $\pm 0.2$  mm
- 3) Adhesion strength of cover tape: Adhesion strength is 0.1-0.7 N when the cover tape is turned off from the carrier tape at  $10^\circ$  angle to the carrier tape
- 4) Packaging: P/N, Manufacturing data code no. and quantity are indicated on the aluminum packing bag

## 8. Label Structure

### a) Label Structure

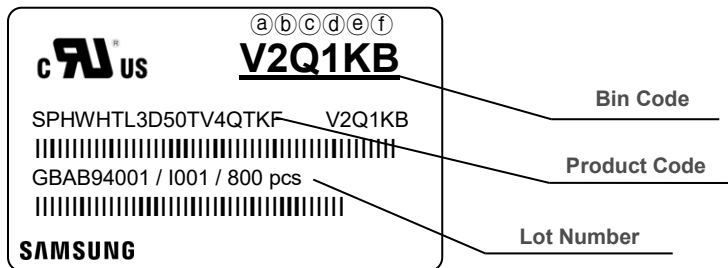

Note: Denoted bin code and product code above is only an example (see description on page 7)

Bin Code:

- ⒶⒷ: Forward Voltage bin (refer to 7 page )
- ⒸⒹ: Chromaticity bin (refer to 7 page )
- ⒺⒻ: Luminous Flux bin (refer to 7 page )

### b) Lot Number

The lot number is composed of the following characters:

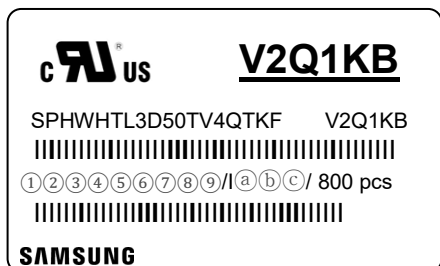

①②③④⑤⑥⑦⑧⑨ / IⒶⒷⒸ / 800 pcs

- ①, ② : Production site (GB : Nanchang, China)
- ③ : Product state (A: Normal, B: Bulk, C: First Production, R: Reproduction, S: Sample)
- ④ : Year (Y: 2014, Z: 2015, A: 2016, B: 2017, C: 2018, D: 2019 ...)
- ⑤ : Month (1~9, A, B, C)
- ⑥ : Day (1~9, A, B~V)
- ⑦⑧⑨ : Product serial number (001 ~ 999)
- ⒶⒷⒸ : Reel number (001 ~ 999)



## 9. Packing Structure

### a) Packing Process

Reel

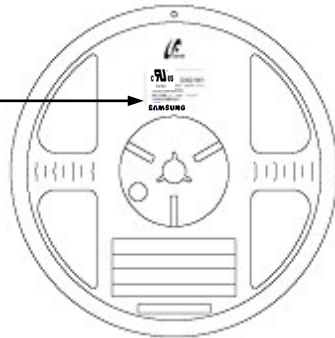
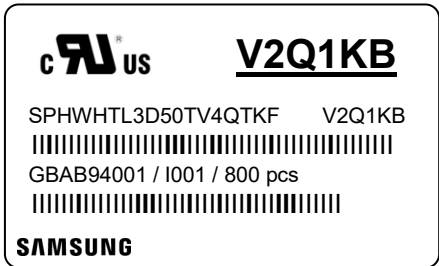

Aluminum Vinyl Packing Bag

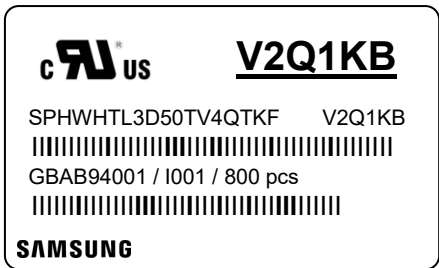

Outer Box

Material: Paper SW(B)

Type	Size (mm)			Note
	(a)	(b)	(c)	
7 inch (L)	245 ± 5	220 ± 5	182 ± 5	Up to 8 reels
7 inch (S)	245 ± 5	220 ± 5	86 ± 5	Up to 4 reels

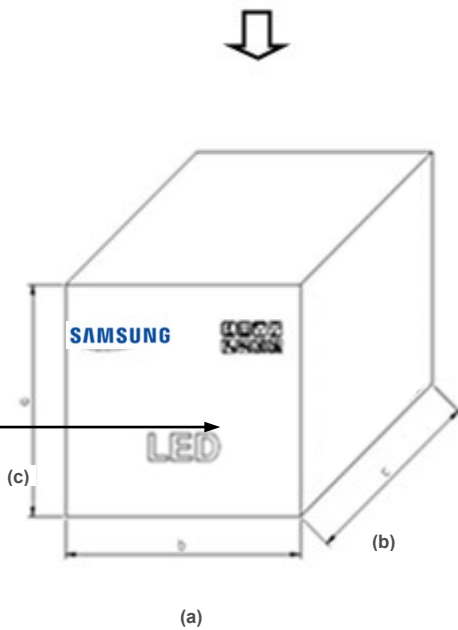
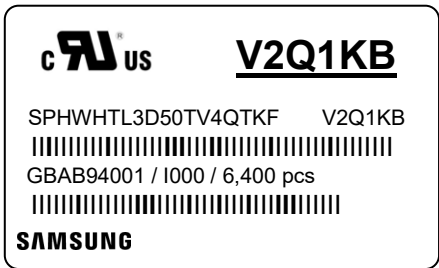

b) Aluminum Vinyl Packing Bag



**CAUTION**  
 This bag contains  
**MOISTURE SENSITIVE DEVICES**

**LEVEL**  
2a

1. Shelf life in sealed bag: 12 months at <math>< 40^{\circ}\text{C}</math> and <math>< 90\%</math> relative humidity (RH)
2. Peak package body temperature: 240 °C
3. After this bag is opened, devices that will be subjected to reflow solder or other high temperature processes must be:
  - a. Mounted within 672 hours at factory conditions of equal to or less than 30°C / 60% RH, or
  - b. Stored at <math>< 10\%</math> RH
4. Devices require bake, before mounting, if:
  - a. Humidity Indicator Card is > 65% when read at 23±5°C, or
  - b. 2a is not met.
5. If baking is required, devices must be baked for 1 hours at 60±5°C

Note: If device containers cannot be subjected to high temperature or shorter bake times are desired, reference IPC/JEDEC J-STD-033 for bake procedure.

Bag seal due date: \_\_\_\_\_  
 (if blank, see code label)

Note: Level and body temperature by IPC/JEDEC J-STD-020



**V2Q1KB**  
 SPHWHTL3D50TV4QTKF    V2Q1KB  
 GBAB94001 / I001 / 800 pcs



**SAMSUNG**



LEAD-FREE





ATTENTION  
OBSERVE PRECAUTIONS  
FOR HANDLING  
ELECTROSTATIC  
SENSITIVE  
DEVICES



OTHER

**주의 사항**

이 알루미늄 지퍼 백은 습기 및 정전기로부터 제품을 보호하기 위하여 제작되었습니다. 개봉 후에는 즉시 솔더 작업을 실시하는 것을 권장합니다.

습기 및 정전기로부터 제품을 보호 하기 위해서 개봉 후 사용하지 않는 자재는 본 팩에 넣어 보관 하시기 바랍니다. 사용하지 않는 자재를 본 팩에 넣을 때는 반드시 동봉된 드라이 팩과 함께 넣고 지퍼부분을 완전하게 밀봉하여 주시기 바랍니다.

**Important**

This Al Zipper bag is designed to protect the enclosed products from moisture and ESD. Once opened, the products should be soldered onto the printed circuit board immediately. When not in use, please do not leave the products unprotected by the Al Zipper Bag. To repack unused products., please ensure the zip-lock is completely sealed with the dry pack left inside.

c) Silica Gel & Humidity Indicator Card inside Aluminum Vinyl Bag

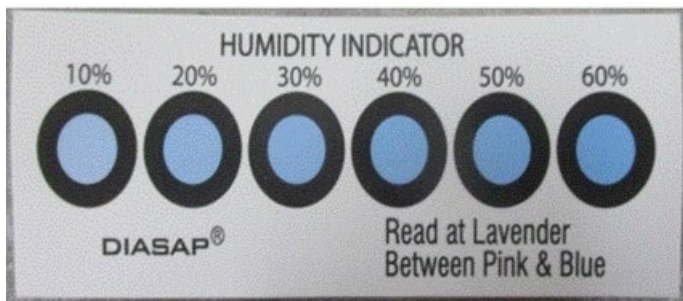

## 10. Precautions in Handling & Use

- 1) For over-current protection, users are recommended to apply resistors connected in series with the LEDs to mitigate sudden change of the forward current caused by shift of forward voltage.
- 2) This device should not be used in any type of fluid such as water, oil, organic solvent, etc. When cleaning is required, IPA is recommended as the cleaning agent. Some solvent-based cleaning agent may damage the silicone resins used in the device.
- 3) When the device is in operation, the forward current should be carefully determined considering the maximum ambient temperature and corresponding junction temperature.
- 4) LEDs must be stored in a clean environment. If the LEDs are to be stored for three months or more after being shipped from Samsung, they should be packed with a nitrogen-filled container (shelf life of sealed bags is 12 months at temperature 0~40 °C, 0~90 % RH).
- 5) After storage bag is opened, device subjected to soldering, solder reflow, or other high temperature processes must be:
  - a. Mounted within 672 hours (28 days) at an assembly line with a condition of no more than 30 °C / 60 % RH, or
  - b. Stored at <10 % RH
- 6) Repack unused devices with anti-moisture packing, fold to close any opening and then store in a dry place.
- 7) Devices require baking before mounting, if humidity card reading is >60 % at  $23 \pm 5$  °C.
- 8) Devices must be baked for 1 hour at  $60 \pm 5$  °C, if baking is required.
- 9) The LEDs are sensitive to the static electricity and surge current. It is recommended to use a wrist band or anti-electrostatic glove when handling the LEDs. If voltage exceeding the absolute maximum rating is applied to LEDs, it may cause damage or even destruction to LED devices. Damaged LEDs may show some unusual characteristics such as increase in leakage current, lowered turn-on voltage, or abnormal lighting of LEDs at low current.
- 10) VOCs (Volatile Organic Compounds) can be generated from adhesives, flux, hardener or organic additives used in luminaires (fixtures). Transparent LED silicone encapsulant is permeable to those chemicals and they may lead to a discoloration of encapsulant when they exposed to heat or light. This phenomenon can cause a significant loss of light emitted (output) from the luminaires. In order to prevent these problems, we recommend users to know the physical properties of materials used in luminaires and they must be carefully selected.

# Legal and additional information.

## [About Samsung Electronics Co., Ltd.](#)

Samsung Electronics Co., Ltd. inspires the world and shapes the future with transformative ideas and technologies, redefining the worlds of TVs, smartphones, wearable devices, tablets, cameras, digital appliances, printers, medical equipment, network systems and semiconductors.

We are also leading in the Internet of Things space through, among others, our Digital Health and Smart Home initiatives. We employ 307,000 people across 84 countries. To discover more, please visit our official website at [www.samsung.com](http://www.samsung.com) and our official blog at [global.samsungtomorrow.com](http://global.samsungtomorrow.com).

"Samsung provides limited warranty for its LED products, the full text of which is available at <https://www.samsung.com/led/support/warranties>"

Copyright © 2017 Samsung Electronics Co., Ltd. All rights reserved.

Samsung is a registered trademark of Samsung Electronics Co., Ltd.

Specifications and designs are subject to change without notice. Non-metric weights and measurements are approximate. All data were deemed correct at time of creation. Samsung is not liable for errors or omissions. All brand, product, service names and logos are trademarks and/or registered trademarks of their respective owners and are hereby recognized and acknowledged.

Samsung Electronics Co., Ltd.

1, Samsung ro

Giheung-gu

Yongin-si, Gyeonggi-do, 17113

KOREA

[www.samsungled.com](http://www.samsungled.com)

The Samsung logo, consisting of the word "SAMSUNG" in a bold, blue, sans-serif font.