

Data sheet | Item number: 279-674/281-434

Component terminal block; 3-conductor; LED (red); 24 VDC; for DIN-rail 35 x 15 and 35 x 7.5; 1.5 mm<sup>2</sup>; CAGE CLAMP®; 1,50 mm<sup>2</sup>; gray

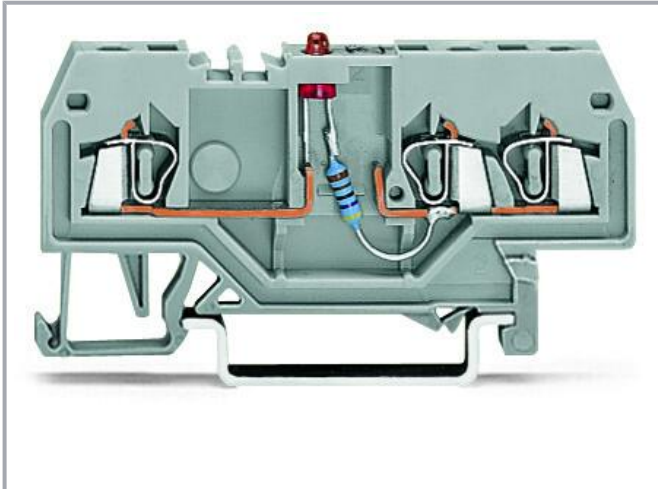

[www.wago.com/279-674/281-434](http://www.wago.com/279-674/281-434)



Color: —

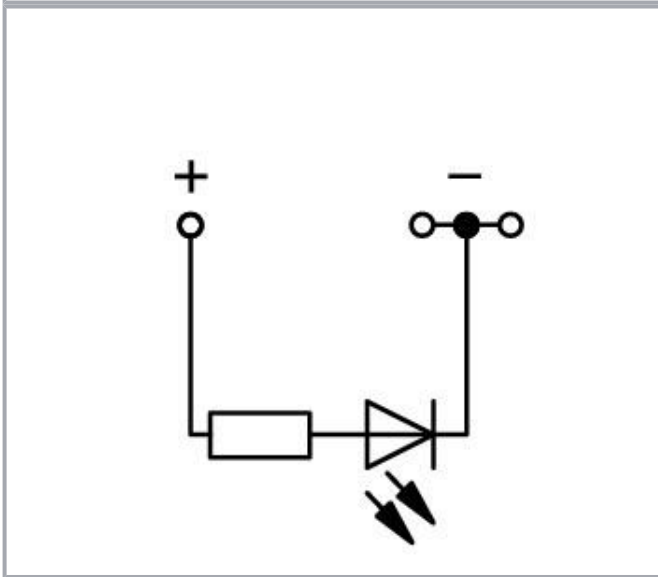
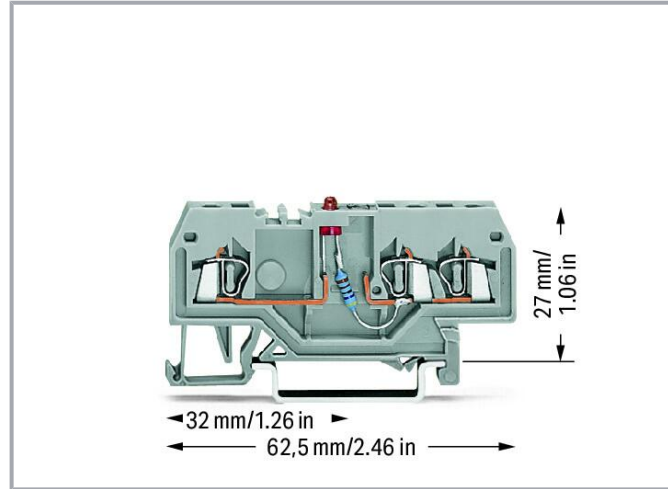

## Data

### Electrical data

### Ratings per IEC/EN

Ratings per

IEC/EN 60947-7-1

Subject to changes. Please also observe the further product documentation!

WAGO GmbH & Co. KG

Hansastr. 27

32423 Minden

Phone: +49571 887-0 | Fax: +49571 887-169

Email: [info.de@wago.com](mailto:info.de@wago.com) | Web: [www.wago.com](http://www.wago.com)

Do you have any questions about our products?

We are always happy to take your call at +49 (571) 887-44222.



Rated current	0.025 A
---------------	---------

## General

Voltage type 1	DC
Nominal voltage	24 V

## Connection data

Connection points	3
Total number of potentials	1
Number of levels	1

## Connection 1

Connection technology	CAGE CLAMP®
Actuation type	Operating tool
Connectable conductor materials	Copper
Solid conductor	0.08 ... 1.5 mm <sup>2</sup> / 28 ... 16 AWG
Fine-stranded conductor	0.08 ... 1.5 mm <sup>2</sup> / 28 ... 16 AWG
Strip length	8 ... 9 mm / 0.31 ... 0.35 inches
Wiring direction	Front-entry wiring

## Physical data

Width	4 mm / 0.157 inches
Height	62.5 mm / 2.461 inches
Depth from upper-edge of DIN-rail	27 mm / 1.063 inches

## Mechanical Data

Design	horizontal type
Mounting type	DIN-35 rail
Marking level	Center marking

## Material Data

Note (material data)	<a href="#">Information on material specifications can be found here</a>
Color	gray
Material group	I

Subject to changes. Please also observe the further product documentation!



Insulation material	Polyamide (PA66)
Flammability class per UL94	V0
Fire load	0.105 MJ
Weight	5.6 g

### Environmental requirements

Processing temperature	-35 ... +85 °C
Continuous operating temperature	-60 ... +105 °C

### Commercial data



Product Group	1 (Rail Mounted Terminal Blocks)
eCl@ss 10.0	27-14-11-27
eCl@ss 9.0	27-14-11-27
ETIM 8.0	EC000903
ETIM 7.0	EC000903
PU (SPU)	100 pcs
Packaging type	box
Country of origin	DE
GTIN	4045454194031
Customs tariff number	85369010000

### Environmental Product Compliance

RoHS Compliance Status	Compliant, No Exemption
------------------------	-------------------------

### Required accessories

#### End plate

End plate		
	Item no.: 279-308 End and intermediate plate; 2 mm thick; gray	<a href="http://www.wago.com/279-308">www.wago.com/279-308</a>
	Item no.: 279-339 End and intermediate plate; 2 mm thick; orange	<a href="http://www.wago.com/279-339">www.wago.com/279-339</a>

### Optional accessories

#### Protective warning marker

Cover	
-------	--

Subject to changes. Please also observe the further product documentation!

**Item no.: 279-415**

Protective warning marker; 5-pole; with high-voltage symbol, black; yellow

[www.wago.com/279-415](http://www.wago.com/279-415)**Jumpers**

## Jumper

**Item no.: 279-492**

Jumper; 2-way; insulated; gray

[www.wago.com/279-492](http://www.wago.com/279-492)**Item no.: 279-490**

Jumper; 10-way; insulated; gray

[www.wago.com/279-490](http://www.wago.com/279-490)**Item no.: 279-482**

Jumper; 2-way; insulated; gray

[www.wago.com/279-482](http://www.wago.com/279-482)**Item no.: 279-483**

Jumper; 3-way; insulated; gray

[www.wago.com/279-483](http://www.wago.com/279-483)**Carrier rail**

## Mounting accessories

**Item no.: 210-197**

Steel carrier rail; 35 x 15 mm; 1.5 mm thick; 2 m long; slotted; similar to EN 60715; silver-colored

[www.wago.com/210-197](http://www.wago.com/210-197)**Item no.: 210-198**

Copper carrier rail; 35 x 15 mm; 2.3 mm thick; 2 m long; unslotted; according to EN 60715; copper-colored

[www.wago.com/210-198](http://www.wago.com/210-198)**Item no.: 210-504**

Steel carrier rail; 35 x 7.5 mm; 1 mm thick; 2 m long; slotted; galvanized; according to EN 60715; silver-colored

[www.wago.com/210-504](http://www.wago.com/210-504)**Item no.: 210-505**

Steel carrier rail; 35 x 7.5 mm; 1 mm thick; 2 m long; unslotted; galvanized; according to EN 60715; silver-colored

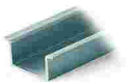
[www.wago.com/210-505](http://www.wago.com/210-505)**Item no.: 210-506**

Steel carrier rail; 35 x 15 mm; 1.5 mm thick; 2 m long; unslotted; galvanized; similar to EN 60715; silver-colored

[www.wago.com/210-506](http://www.wago.com/210-506)**Item no.: 210-508**

Steel carrier rail; 35 x 15 mm; 1.5 mm thick; 2 m long; slotted; galvanized; similar to EN 60715; silver-colored

[www.wago.com/210-508](http://www.wago.com/210-508)**Item no.: 210-113**

Steel carrier rail; 35 x 7.5 mm; 1 mm thick; 2 m long; unslotted; according to EN 60715; silver-colored

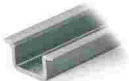
[www.wago.com/210-113](http://www.wago.com/210-113)**Item no.: 210-118**

Steel carrier rail; 35 x 15 mm; 2.3 mm thick; 2 m long; unslotted; according to EN 60715; silver-colored

[www.wago.com/210-118](http://www.wago.com/210-118)**Item no.: 210-112**Steel carrier rail; 35 x 7.5 mm; 1 mm thick; 2 m long; slotted; according to EN 60715; "Hole width 25 mm; silver-colored" [www.wago.com/210-112](http://www.wago.com/210-112)

Subject to changes. Please also observe the further product documentation!

WAGO GmbH &amp; Co. KG

Hansastr. 27

32423 Minden

Phone: +49571 887-0 | Fax: +49571 887-169

Email: [info.de@wago.com](mailto:info.de@wago.com) | Web: [www.wago.com](http://www.wago.com)

Do you have any questions about our products?

We are always happy to take your call at +49 (571) 887-44222.



**Item no.: 210-114**

Steel carrier rail; 35 x 15 mm; 1.5 mm thick; 2 m long; unslotted; similar to EN 60715; silver-colored

[www.wago.com/210-114](http://www.wago.com/210-114)



**Item no.: 210-115**

Steel carrier rail; 35 x 7.5 mm; 1 mm thick; 2 m long; slotted; according to EN 60715; "Hole width 18 mm; [www.wago.com/210-115](http://www.wago.com/210-115) silver-colored



**Item no.: 210-196**

Aluminum carrier rail; 35 x 8.2 mm; 1.6 mm thick; 2 m long; unslotted; similar to EN 60715; silver-colored

[www.wago.com/210-196](http://www.wago.com/210-196)

## Tool

### Operating tool



**Item no.: 210-648**

Operating tool; Blade: 2.5 x 0.4 mm; with a partially insulated shaft; angled; short

[www.wago.com/210-648](http://www.wago.com/210-648)



**Item no.: 210-647**

Operating tool; Blade: 2.5 x 0.4 mm; with a partially insulated shaft; multicoloured

[www.wago.com/210-647](http://www.wago.com/210-647)



**Item no.: 210-719**

Operating tool; Blade: 2.5 x 0.4 mm; with a partially insulated shaft

[www.wago.com/210-719](http://www.wago.com/210-719)

## Mounting

### Cover



**Item no.: 709-153**

Cover; Type 1; suitable for cover carrier, type 1; 1 m long; transparent

[www.wago.com/709-153](http://www.wago.com/709-153)

### Mounting accessories



**Item no.: 209-106**

Mounting carrier; for isolated mounting on DIN 35 rails; gray

[www.wago.com/209-106](http://www.wago.com/209-106)



**Item no.: 249-116**

Screwless end stop; 6 mm wide; for DIN-rail 35 x 15 and 35 x 7.5; gray

[www.wago.com/249-116](http://www.wago.com/249-116)

## Insulation stop

### Insulation stop



**Item no.: 279-470**

Insulation stop; 0.08 - 0.2 mm<sup>2</sup> "s" (0.14 mm<sup>2</sup> "f-st"); 5 pieces/strip; white

[www.wago.com/279-470](http://www.wago.com/279-470)



**Item no.: 279-471**

Insulation stop; 0.25 mm<sup>2</sup>; 5 pieces/strip; dark gray

[www.wago.com/279-471](http://www.wago.com/279-471)

## Ferrule

### Ferrule



**Item no.: 216-101**

Ferrule; Sleeve for 0.5 mm<sup>2</sup> / AWG 22; uninsulated; electro-tin plated; silver-colored

[www.wago.com/216-101](http://www.wago.com/216-101)

Subject to changes. Please also observe the further product documentation!

WAGO GmbH & Co. KG

Hansastr. 27







32423 Minden

Phone: +49571 887-0 | Fax: +49571 887-169







Email: [info.de@wago.com](mailto:info.de@wago.com) | Web: [www.wago.com](http://www.wago.com)

Do you have any questions about our products?

We are always happy to take your call at +49 (571) 887-44222.

	<b>Item no.: 216-102</b> Ferrule; Sleeve for 0.75 mm <sup>2</sup> / AWG 20; uninsulated; electro-tin plated; silver-colored	<a href="http://www.wago.com/216-102">www.wago.com/216-102</a>
	<b>Item no.: 216-103</b> Ferrule; Sleeve for 1 mm <sup>2</sup> / AWG 18; uninsulated; electro-tin plated	<a href="http://www.wago.com/216-103">www.wago.com/216-103</a>
	<b>Item no.: 216-203</b> Ferrule; Sleeve for 1 mm <sup>2</sup> / AWG 18; insulated; electro-tin plated; red	<a href="http://www.wago.com/216-203">www.wago.com/216-203</a>
	<b>Item no.: 216-202</b> Ferrule; Sleeve for 0.75 mm <sup>2</sup> / 18 AWG; insulated; electro-tin plated; gray	<a href="http://www.wago.com/216-202">www.wago.com/216-202</a>
	<b>Item no.: 216-201</b> Ferrule; Sleeve for 0.5 mm <sup>2</sup> / 20 AWG; insulated; electro-tin plated; white	<a href="http://www.wago.com/216-201">www.wago.com/216-201</a>
	<b>Item no.: 216-301</b> Ferrule; Sleeve for 0.25 mm <sup>2</sup> / AWG 24; insulated; electro-tin plated; yellow	<a href="http://www.wago.com/216-301">www.wago.com/216-301</a>
	<b>Item no.: 216-302</b> Ferrule; Sleeve for 0.34 mm <sup>2</sup> / 22 AWG; insulated; electro-tin plated; light turquoise	<a href="http://www.wago.com/216-302">www.wago.com/216-302</a>

**Marking accessories**

Marker		
	<b>Item no.: 2009-114/000-002</b> WMB-Inline; for Smart Printer; 2000 pieces on roll; stretchable 4 - 4.2 mm; plain; snap-on type; yellow	<a href="http://www.wago.com/2009-114/000-002">www.wago.com/2009-114/000-002</a>
	<b>Item no.: 2009-114/000-005</b> WMB-Inline; for Smart Printer; 2000 pieces on roll; stretchable 4 - 4.2 mm; plain; snap-on type; red	<a href="http://www.wago.com/2009-114/000-005">www.wago.com/2009-114/000-005</a>
	<b>Item no.: 2009-114/000-007</b> WMB-Inline; for Smart Printer; 2000 pieces on roll; stretchable 4 - 4.2 mm; plain; snap-on type; gray	<a href="http://www.wago.com/2009-114/000-007">www.wago.com/2009-114/000-007</a>
	<b>Item no.: 2009-114/000-023</b> WMB-Inline; for Smart Printer; 2000 pieces on roll; stretchable 4 - 4.2 mm; plain; snap-on type; green	<a href="http://www.wago.com/2009-114/000-023">www.wago.com/2009-114/000-023</a>
	<b>Item no.: 2009-114/000-006</b> WMB-Inline; for Smart Printer; 2000 pieces on roll; stretchable 4 - 4.2 mm; plain; snap-on type; blue	<a href="http://www.wago.com/2009-114/000-006">www.wago.com/2009-114/000-006</a>
	<b>Item no.: 2009-114/000-024</b> WMB-Inline; for Smart Printer; 2000 pieces on roll; stretchable 4 - 4.2 mm; plain; snap-on type; violet	<a href="http://www.wago.com/2009-114/000-024">www.wago.com/2009-114/000-024</a>
	<b>Item no.: 2009-114/000-012</b> WMB-Inline; for Smart Printer; 2000 pieces on roll; stretchable 4 - 4.2 mm; plain; snap-on type; orange	<a href="http://www.wago.com/2009-114/000-012">www.wago.com/2009-114/000-012</a>

Subject to changes. Please also observe the further product documentation!



Item no.: 2009-114

WMB-Inline; for Smart Printer; 2000 pieces on roll; stretchable 4 - 4.2 mm; plain; snap-on type; white

[www.wago.com/2009-114](http://www.wago.com/2009-114)



Item no.: 793-4501/000-002

WMB marking card; as card; stretchable 4 - 4.2 mm; plain; snap-on type; yellow

[www.wago.com/793-4501/000-002](http://www.wago.com/793-4501/000-002)



Item no.: 793-4501/000-006

WMB marking card; as card; stretchable 4 - 4.2 mm; plain; snap-on type; blue

[www.wago.com/793-4501/000-006](http://www.wago.com/793-4501/000-006)



Item no.: 793-4501/000-014

WMB marking card; as card; stretchable 4 - 4.2 mm; plain; snap-on type; brown

[www.wago.com/793-4501/000-014](http://www.wago.com/793-4501/000-014)



Item no.: 793-4501

WMB marking card; as card; stretchable 4 - 4.2 mm; plain; snap-on type; white

[www.wago.com/793-4501](http://www.wago.com/793-4501)



Item no.: 793-4501/000-023

WMB marking card; as card; stretchable 4 - 4.2 mm; plain; snap-on type; green

[www.wago.com/793-4501/000-023](http://www.wago.com/793-4501/000-023)



Item no.: 793-4501/000-024

WMB marking card; as card; stretchable 4 - 4.2 mm; plain; snap-on type; violet

[www.wago.com/793-4501/000-024](http://www.wago.com/793-4501/000-024)



Item no.: 793-4501/000-005

WMB marking card; as card; stretchable 4 - 4.2 mm; plain; snap-on type; red

[www.wago.com/793-4501/000-005](http://www.wago.com/793-4501/000-005)



Item no.: 793-4501/000-007

WMB marking card; as card; stretchable 4 - 4.2 mm; plain; snap-on type; gray

[www.wago.com/793-4501/000-007](http://www.wago.com/793-4501/000-007)



Item no.: 793-4501/000-012

WMB marking card; as card; stretchable 4 - 4.2 mm; plain; snap-on type; orange

[www.wago.com/793-4501/000-012](http://www.wago.com/793-4501/000-012)



Item no.: 793-4501/000-017

WMB marking card; as card; stretchable 4 - 4.2 mm; plain; snap-on type; light green

[www.wago.com/793-4501/000-017](http://www.wago.com/793-4501/000-017)

Group marker carrier

Subject to changes. Please also observe the further product documentation!

WAGO GmbH & Co. KG

Hansastr. 27

32423 Minden

Phone: +49571 887-0 | Fax: +49571 887-169

Email: [info.de@wago.com](mailto:info.de@wago.com) | Web: [www.wago.com](http://www.wago.com)

Do you have any questions about our products?

We are always happy to take your call at +49 (571) 887-44222.



Item no.: 249-105  
Group marker carrier; gray

[www.wago.com/249-105](http://www.wago.com/249-105)

## Downloads Documentation

### Bid Text

279-674/281-434 X81 - Datei	2019 Feb 19	xml 3.3 kB	Download
--------------------------------	-------------	---------------	----------

279-674/281-434 doc - Datei	2017 Apr 10	doc 25.1 kB	Download
--------------------------------	-------------	----------------	----------

### Additional Information

Technical Section Technical explanations		pdf 2.2 MB	Download
---	--	---------------	----------

## CAD/CAE-Data

### CAE data

EPLAN Data Portal 279-674/281-434	URL	Download
-----------------------------------	-----	----------

WSCAD Universe 279-674/281-434	URL	Download
--------------------------------	-----	----------

ZUKEN Portal 279-674/281-434	URL	Download
------------------------------	-----	----------

WSCAD Universe 279-674/281-434	URL	Download
--------------------------------	-----	----------

EPLAN Data Portal 279-674/281-434	URL	Download
-----------------------------------	-----	----------

### CAD data

2D/3D Models 279-674/281-434	URL	Download
------------------------------	-----	----------

## Environmental Product Compliance

### Compliance Search

Environmental Product Compliance 279-674/281-434

Subject to changes. Please also observe the further product documentation!

WAGO GmbH & Co. KG  
Hansastr. 27  
32423 Minden  
Phone: +49571 887-0 | Fax: +49571 887-169  
Email: [info.de@wago.com](mailto:info.de@wago.com) | Web: [www.wago.com](http://www.wago.com)

Do you have any questions about our products?  
We are always happy to take your call at +49 (571) 887-44222.



Component terminal block; 3-conductor; LED (red); 24 VDC; for DIN-rail 35 x 15 and 35 x 7.5; 1.5 mm<sup>2</sup>; CAGE CLAMP®; 1,50 mm<sup>2</sup>; gray

## Installation Notes

### Commoning



Commoning using comb-style jumper bars:  
Push comb-style jumper bars down until fully inserted.

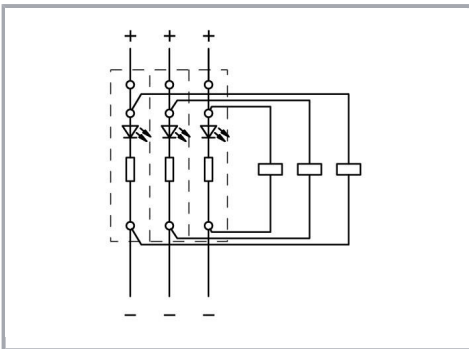

Circuit-related voltage indications can be created using the following terminal blocks:

279-674/281-434 or 279-674/281-413

Subject to changes. Please also observe the further product documentation!