

Data sheet | Item number: 787-783

Redundancy Module; 2 x 9 ... 54 VDC input voltage; 2 x 12.5 A input current;
9–54 VDC output voltage; 25 A output current

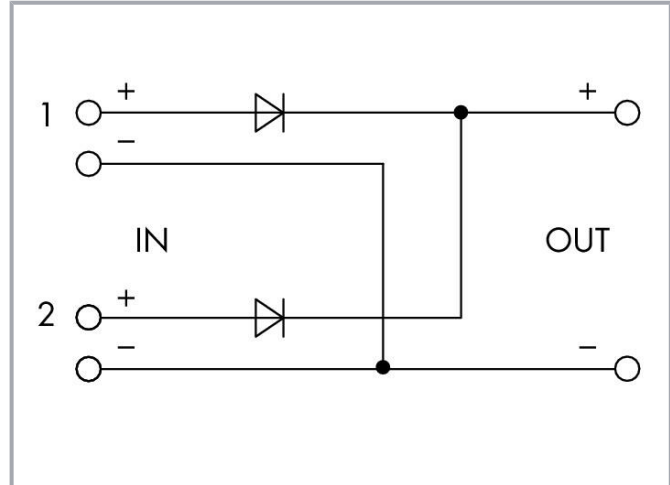

www.wago.com/787-783



Similar to illustration

Item description

Features:

- Redundancy module with two inputs decouples two power supplies.
- For redundant and fail-safe power supply
- With LED for input voltage monitoring on site and remotely

Subject to changes. Please also observe the further product documentation!

WAGO GmbH & Co. KG
Hansastr. 27
32423 Minden
Phone: +49571 887-0 | Fax: +49571 887-169
Email: info.de@wago.com | Web: www.wago.com

Do you have any questions about our products?
We are always happy to take your call at +49 (571) 887-44222.

Data

Technical data

Input

Nominal input voltage $U_{i\text{ nom}}$	2 x DC 24 V
Input voltage range	2 x DC 9 ... 54 V
Nominal mains frequency range	0 Hz
Input current I_i	≤ 12.5 A (per path); ≤ 25 A (in total)

Output

Nominal output voltage $U_{o\text{ nom}}$	DC 24 V
Output voltage range	DC 9 ... 54 V (U_e – voltage drop)
Voltage drop	≤ 0.8 V (Input/output)
Nominal output current $I_{o\text{ nom}}$	12.5 A (redundancy operation); 25 A (parallel operation)
Nominal output power	600 W

Signaling and Communication

Signaling	1 x IN1 LED (green) 1 x IN2 LED (green) 1 x OUT LED (green)
Operation status indicator	2 x Green LED ($U_i > 7.5$ VDC) 1 x Green LED ($U_o > 7.5$ VDC)

Efficiency/power losses

Power loss P_i	≤ 19 W (nominal load)
Efficiency (typ.)	96 %

Safety and protection

Protection class	III
Protection type	IP20; per EN 60529
Pollution degree	2
Overvoltage protection; secondary	No
Short-circuit-protected	No

Subject to changes. Please also observe the further product documentation!



Open-circuit-proof	Yes
Parallel operation	Yes
Series operation	No
MTBF	> 10 million h (per IEC 61709)

Connection data

Connection type 1	Input/output
Connection technology	Push-in CAGE CLAMP®
WAGO connector	WAGO 2706 Series
Solid conductor	0.5 ... 6 mm ² / 20 ... 10 AWG
Fine-stranded conductor	0.5 ... 6 mm ² / 20 ... 10 AWG
Strip length	11 ... 12 mm / 0.43 ... 0.47 inches

Physical data

Width	50 mm / 1.969 inches
Height	130 mm / 5.118 inches
Depth from upper-edge of DIN-rail	92 mm / 3.662 inches

Mechanical Data

Mounting type	DIN-35 rail
---------------	-------------

Material Data

Weight	31.1 g
--------	--------

Environmental requirements

Ambient temperature (operation)	-25 ... +70 °C
Ambient temperature (storage)	-40 ... +85 °C
Relative humidity	95% (no condensation permissible)
Derating	-2.66 %/K (55 °C < T _u ≤ 70 °C)
Resistance to shock and vibration	Shock: 15g (per EN 60068-2-27)

Standards and specifications

Conformity marking	CE
Standards/specifications	UL 508

Subject to changes. Please also observe the further product documentation!

WAGO GmbH & Co. KG
 Hansastr. 27
 32423 Minden
 Phone: +49571 887-0 | Fax: +49571 887-169
 Email: info.de@wago.com | Web: www.wago.com

Do you have any questions about our products?
 We are always happy to take your call at +49 (571) 887-44222.

Commercial data

eCl@ss 10.0	27-04-07-01
eCl@ss 9.0	27-04-07-01
ETIM 8.0	EC002540
ETIM 7.0	EC002540
PU (SPU)	1 pcs
Packaging type	Box
Country of origin	CN
GTIN	4055143036290
Customs tariff number	85044095900

Environmental Product Compliance



RoHS Compliance Status	Compliant,With Exemption
RoHS Exemption	6(c) 7(a) 7(c)-I 7(c)-II
SCIP notification number (Bulgaria)	ee8b3ea5-15c1-45d9-8bcc-d73670c4c6fe
SCIP notification number (Czech Republic)	30618d2b-98b4-4bd3-9376-269bf618f4a8

Approvals / Certificates

General approvals

Logo	Approval	Additional Approval Text	Certificate name
	UL Underwriters Laboratories Inc.	UL 508	E255817

Declarations of conformity and manufacturer's declarations

Logo	Approval	Additional Approval Text	Certificate name
	EU-Declaration of Conformity WAGO GmbH & Co. KG	-	-
	UK-Declaration of Conformity WAGO GmbH & Co. KG	-	-















Subject to changes. Please also observe the further product documentation!

WAGO GmbH & Co. KG
Hansastr. 27
32423 Minden
Phone: +49571 887-0 | Fax: +49571 887-169
Email: info.de@wago.com | Web: www.wago.com



Do you have any questions about our products?
We are always happy to take your call at +49 (571) 887-44222.

Optional accessories

Ferrule

Ferrule		
	Item no.: 216-203 Ferrule; Sleeve for 1 mm ² / AWG 18; insulated; electro-tin plated; red	www.wago.com/216-203
	Item no.: 216-206 Ferrule; Sleeve for 2.5 mm ² / AWG 14; insulated; electro-tin plated; blue	www.wago.com/216-206
	Item no.: 216-207 Ferrule; Sleeve for 4 mm ² / AWG 12; insulated; electro-tin plated; gray	www.wago.com/216-207
	Item no.: 216-202 Ferrule; Sleeve for 0.75 mm ² / 18 AWG; insulated; electro-tin plated; gray	www.wago.com/216-202
	Item no.: 216-204 Ferrule; Sleeve for 1.5 mm ² / AWG 16; insulated; electro-tin plated; black	www.wago.com/216-204
	Item no.: 216-205 Ferrule; Sleeve for 2.08 mm ² / AWG 14; insulated; electro-tin plated; yellow	www.wago.com/216-205
	Item no.: 216-208 Ferrule; Sleeve for 6 mm ² / AWG 10; insulated; electro-tin plated; electrolytic copper; gastight crimped; acc. to DIN 46228, Part 4/09.90; yellow	www.wago.com/216-208
	Item no.: 216-201 Ferrule; Sleeve for 0.5 mm ² / 20 AWG; insulated; electro-tin plated; white	www.wago.com/216-201
	Item no.: 216-223 Ferrule; Sleeve for 1 mm ² / AWG 18; insulated; electro-tin plated; red	www.wago.com/216-223
	Item no.: 216-241 Ferrule; Sleeve for 0.5 mm ² / 20 AWG; insulated; electro-tin plated; electrolytic copper; gastight crimped; acc. to DIN 46228, Part 4/09.90; white	www.wago.com/216-241
	Item no.: 216-242 Ferrule; Sleeve for 0.75 mm ² / 18 AWG; insulated; electro-tin plated; electrolytic copper; gastight crimped; acc. to DIN 46228, Part 4/09.90; gray	www.wago.com/216-242
	Item no.: 216-222 Ferrule; Sleeve for 0.75 mm ² / 18 AWG; insulated; electro-tin plated; gray	www.wago.com/216-222
	Item no.: 216-221 Ferrule; Sleeve for 0.5 mm ² / 20 AWG; insulated; electro-tin plated; white	www.wago.com/216-221
	Item no.: 216-224 Ferrule; Sleeve for 1.5 mm ² / AWG 16; insulated; electro-tin plated; black	www.wago.com/216-224
	Item no.: 216-243 Ferrule; Sleeve for 1 mm ² / AWG 18; insulated; electro-tin plated; electrolytic copper; gastight crimped; acc. to DIN 46228, Part 4/09.90; red	www.wago.com/216-243

Subject to changes. Please also observe the further product documentation!

	Item no.: 216-244 Ferrule; Sleeve for 1.5 mm ² / AWG 16; insulated; electro-tin plated; electrolytic copper; gastight crimped; acc. to DIN 46228, Part 4/09.90; black	www.wago.com/216-244
	Item no.: 216-263 Ferrule; Sleeve for 1 mm ² / AWG 18; insulated; electro-tin plated; electrolytic copper; gastight crimped; acc. to DIN 46228, Part 4/09.90; red	www.wago.com/216-263
	Item no.: 216-246 Ferrule; Sleeve for 2.5 mm ² / AWG 14; insulated; electro-tin plated; electrolytic copper; gastight crimped; acc. to DIN 46228, Part 4/09.90; blue	www.wago.com/216-246
	Item no.: 216-266 Ferrule; Sleeve for 2.5 mm ² / AWG 14; insulated; electro-tin plated; electrolytic copper; gastight crimped; acc. to DIN 46228, Part 4/09.90; blue	www.wago.com/216-266
	Item no.: 216-264 Ferrule; Sleeve for 1.5 mm ² / AWG 16; insulated; electro-tin plated; electrolytic copper; gastight crimped; acc. to DIN 46228, Part 4/09.90; black	www.wago.com/216-264
	Item no.: 216-284 Ferrule; Sleeve for 1.5 mm ² / AWG 16; insulated; electro-tin plated; electrolytic copper; gastight crimped; acc. to DIN 46228, Part 4/09.90; black	www.wago.com/216-284
	Item no.: 216-286 Ferrule; Sleeve for 2.5 mm ² / AWG 14; insulated; electro-tin plated; electrolytic copper; gastight crimped; acc. to DIN 46228, Part 4/09.90; blue	www.wago.com/216-286
	Item no.: 216-287 Ferrule; Sleeve for 4 mm ² / AWG 12; insulated; electro-tin plated; electrolytic copper; gastight crimped; acc. to DIN 46228, Part 4/09.90; gray	www.wago.com/216-287
	Item no.: 216-262 Ferrule; Sleeve for 0.75 mm ² / 18 AWG; insulated; electro-tin plated; electrolytic copper; gastight crimped; acc. to DIN 46228, Part 4/09.90; gray	www.wago.com/216-262
	Item no.: 216-288 Ferrule; Sleeve for 6 mm ² / AWG 10; insulated; electro-tin plated; electrolytic copper; gastight crimped; acc. to DIN 46228, Part 4/09.90; yellow	www.wago.com/216-288
	Item no.: 216-267 Ferrule; Sleeve for 4 mm ² / AWG 12; insulated; electro-tin plated; electrolytic copper; gastight crimped; acc. to DIN 46228, Part 4/09.90; gray	www.wago.com/216-267

Downloads

Documentation

Bid Text

787-783 X81 - Datei	2019 Jul 15	xml 5.6 kB	Download
787-783 docx - Datei	2019 Jul 15	docx 21.9 kB	Download

Instruction Leaflet

Subject to changes. Please also observe the further product documentation!

WAGO GmbH & Co. KG
 Hansastr. 27
 32423 Minden
 Phone: +49571 887-0 | Fax: +49571 887-169
 Email: info.de@wago.com | Web: www.wago.com

Do you have any questions about our products?
 We are always happy to take your call at +49 (571) 887-44222.



Diode Redundancy Module DC 24 V, 12,5 A	V 1.2.0 2021 Sep 29	pdf 3.9 MB	Download
--	------------------------	---------------	----------

Additional Information

Disposal and Recycling Electrical and electronic equipment, Batteries, Packaging	V 1.1.0 2022 Aug 18	pdf 2.2 MB	Download
---	------------------------	---------------	----------

CAD/CAE-Data

CAD data

2D/3D Models 787-783	URL	Download
----------------------	-----	----------

CAE data

WSCAD Universe 787-783	URL	Download
------------------------	-----	----------

EPLAN Data Portal 787-783	URL	Download
---------------------------	-----	----------

ZUKEN Portal 787-783	URL	Download
----------------------	-----	----------

Environmental Product Compliance

Compliance Search

Environmental Product Compliance 787-783 Redundancy Module; 2 x 9 ... 54 VDC input voltage; 2 x 12.5 A input current; 9-54 VDC output voltage; 25 A output current	URL	Download
---	-----	----------

Installation Notes

Subject to changes. Please also observe the further product documentation!