

Middle Power LED Series
2835 18V Hot temp CIE

LM286B+

SA Rank



Designed for better lm/\$ (Lamps)



Features & Benefits

- 0.9W High-Voltage LED
- Standard form factor for design flexibility (2.8 × 3.5)

Table of Contents

1.	Characteristics	-----	3
2.	Product Code Information	-----	6
3.	Typical Characteristics Graphs	-----	16
4.	Outline Drawing & Dimension	-----	21
5.	Reliability Test Items & Conditions	-----	22
6.	Soldering Conditions	-----	23
7.	Tape & Reel	-----	24
8.	Label Structure	-----	27
9.	Packing Structure	-----	28
10.	Precautions in Handling & Use	-----	33

1. Characteristics

a) Absolute Maximum Rating

Item	Symbol	Rating	Unit	Condition
Ambient / Operating Temperature	T_a	-40 ~ +85	°C	-
Storage Temperature	T_{stg}	-40 ~ +85	°C	-
LED Junction Temperature	T_j	125	°C	-
Forward Current	I_F	60	mA	-
Peak Pulsed Forward Current	I_{FP}	120	mA	Duty 1/10, pulse width 10ms
Assembly Process Temperature	-	260 <10	°C s	-
ESD (HBM)	-	2	kV	-

Note:

Proper current derating must be observed to maintain junction temperature below the maximum at all time.

b) Electro-optical Characteristics ($I_F = 50 \text{ mA}$, $T_s = 25 \text{ }^\circ\text{C}$)

Item	Unit	Rank	Bin	Min.	Typ.	Max.
Forward Voltage (VF)	V	W8 or WK	A2	16		17
			A3	17		18
			A4	18	-	19
			A5	19	-	20
Color Rendering Index (Ra)	-	5		80	-	-
		7		90		
Special CRI (R9)	For Ra 90		50			
Thermal Resistance (junction to solder point)	$^\circ\text{C/W}$			-	20	-
Beam Angle	$^\circ$			-	120	-

Note:

Samsung maintains measurement tolerance of: forward voltage = $\pm 0.3 \text{ V}$, CRI = ± 3 , R9 = ± 6.5

b) Electro-optical Characteristics (I_F = 50 mA, T_s = 25 °C)

Item	CRI (R _a) Min.	Nominal CCT (K)	Bin	Sorting @ 50mA	
				Min.	Max.
Luminous Flux (lm)	80	2700	SA	100.0	110.0
		3000	SA	103.0	113.0
		3500	SA	107.0	117.0
		4000	SA	111.0	121.0
		5000	SA	114.0	124.0
		5700	SA	112.0	122.0
		6500	SA	111.0	121.0
	90	2700	SA	85.0	95.0
		3000	SA	88.0	98.0
		3500	SA	91.0	101.0
		4000	SA	95.0	105.0
		5000	SA	97.0	107.0
		5700	SA	96.0	106.0
		6500	SA	95.0	105.0

Note:

Samsung maintains measurement tolerance of: forward voltage = $\pm 0.3V$, luminous flux = $\pm 5\%$, CRI = ± 3 , R9 = ± 6.5

2. Product Code Information

1	2	3	4	5	6	7	8	9	10	11	12	13	14	15	16	17	18
S	P	M	W	H	1	2	2	4	5	Q	5	W	8	R	0	S	A

Digit	PKG Information	Code	Specification	
1 2 3	Samsung Package Middle Power	SPM	Middle power	
4 5	Color	WH	White	
6	Product Version	1	1 st version	
7 8 9	Form Factor	224	2.8 x 3.5 x 0.65 mm; 2 pads	
10	Sorting Current (mA)	5	50mA	
11	Chromaticity Coordinates	Q	ANSI Standard	
12	CRI	5	Min. 80	
		7	Min. 90	
13 14	Forward Voltage (V)	W8 or WK	16~20	Bin code A2 16 ~ 17 A3 17 ~ 18 A4 18 ~ 19 A5 19 ~ 20
		W8: 4,000ea per reel ,WK : 16,000ea per reel		
15 16	CCT (K)	W☆	2700	Bin Code: W1, W2, W3, W4, W5, W6, W7, W8, W9, WA, WB, WC, WD, WE, WF, WG V1, V2, V3, V4, V5, V6, V7, V8, V9, VA, VB, VC, VD, VE, VF, VG U1, U2, U3, U4, U5, U6, U7, U8, U9, UA, UB, UC, UD, UE, UF, UG T1, T2, T3, T4, T5, T6, T7, T8, T9, TA, TB, TC, TD, TE, TF, TG R1, R2, R3, R4, R5, R6, R7, R8, R9,RA,RB,RC,RD,RE,RF,RG Q1, Q2, Q3, Q4, Q5, Q6, Q7, Q8, Q9,QA,QB,QC,QD,QE,QF,QG P1, P2, P3, P4, P5, P6, P7, P8, P9,PA,PB,PC,PD,PE,PF,PG
		V☆	3000	
		U☆	3500	
		T☆	4000	
		R☆	5000	
		Q☆	5700	
		P☆	6500	
☆ : "0" (Whole bin) "M" (Quarter bin) or "K" (kitting bin)				
17 18	Luminous Flux	SA	Bin Code:	SA

a) Luminous Flux Bins ($I_f = 50 \text{ mA}$, $T_s = 25^\circ\text{C}$)

CRI (R_a) Min.	Nominal CCT (K)	Product Code	Flux Bin	Flux Range (Φ_v , lm)
80	2700	SPMWH12245Q5W8W☆SA	SA	100.0 ~ 110.0
	3000	SPMWH12245Q5W8V☆SA	SA	103.0 ~ 113.0
	3500	SPMWH12245Q5W8U☆SA	SA	107.0 ~ 117.0
	4000	SPMWH12245Q5W8T☆SA	SA	111.0 ~ 121.0
	5000	SPMWH12245Q5W8R☆SA	SA	114.0 ~ 124.0
	5700	SPMWH12245Q5W8Q☆SA	SA	112.0 ~ 122.0
	6500	SPMWH12245Q5W8P☆SA	SA	111.0 ~ 121.0
	90	2700	SPMWH12245Q7W8W☆SA	SA
3000		SPMWH12245Q7W8V☆SA	SA	88.0 ~ 98.0
3500		SPMWH12245Q7W8U☆SA	SA	91.0 ~ 101.0
4000		SPMWH12245Q7W8T☆SA	SA	95.0 ~ 105.0
5000		SPMWH12245Q7W8R☆SA	SA	97.0 ~ 107.0
5700		SPMWH12245Q7W8Q☆SA	SA	96.0 ~ 106.0
6500		SPMWH12245Q7W8P☆SA	SA	95.0 ~ 105.0

Note:

"☆" can be "0" (Whole bin), "M" (Quarter bin) or "K" (Kitting bin) of the color binning

b) Kitting rule

1) Kitting bin Concept

1. Under agreement between customer and SAMSUNG ELECTRONICS, SAMSUNG can supply kitting bin (VF, Color, lm).
2. A forward voltage (VF) of kitting bin is combined by a pair of same VF rank such as (A2+A2), (A3+A3), (A4+A4) or (A5+A5).
3. A Chromaticity Coordinates of kitting bin is mixed by kitting procedure.(below kitting simulation)

[Kitting example]

D	E	F	G
9	A	B	C
5	6	7	8
1	2	3	4

[Binning Information]

	Bin #1	Bin #2
VF	A2	A2
	A3	A3
	A4	A4
	A5	A5
CIE	1, 2, 5 bin	C, F, G bin
	6, 7, A, B bin	6, 7, A, B bin
	3, 4, 8 bin	9, D, E bin

c) Color Bins ($I_F = 50 \text{ mA}$, $T_s = 25 \text{ }^\circ\text{C}$)

CRI (Ra) Min.	Nominal CCT (K)	Product Code	Color Rank	Chromaticity Bins
80 or 90	2700	SPMWH12245Q☆W8W0SA	W0 (Whole bin)	W1, W2, W3, W4, W5, W6, W7, W8, W9, WA, WB, WC, WD, WE, WF, WG
		SPMWH12245Q☆W8WMSA	WM (Quarter bin)	W6, W7, WA, WB
		SPMWH12245Q☆W8WKSA	WK (Kitting bin)	W1, W2, W3, W4, W5, W6, W7, W8, W9, WA, WB, WC, WD, WE, WF, WG
	3000	SPMWH12245Q☆W8V0SA	V0 (Whole bin)	V1, V2, V3, V4, V5, V6, V7, V8, V9, VA, VB, VC, VD, VE, VF, VG
		SPMWH12245Q☆W8VMSA	VM (Quarter bin)	V6, V7, VA, VB
		SPMWH12245Q☆W8VKSA	VK (Kitting bin)	V1, V2, V3, V4, V5, V6, V7, V8, V9, VA, VB, VC, VD, VE, VF, VG
	3500	SPMWH12245Q☆W8U0SA	U0 (Whole bin)	U1, U2, U3, U4, U5, U6, U7, U8, U9, UA, UB, UC, UD, UE, UF, UG
		SPMWH12245Q☆W8UMSA	UM (Quarter bin)	U6, U7, UA, UB
		SPMWH12245Q☆W8UKSA	UK (Kitting bin)	U1, U2, U3, U4, U5, U6, U7, U8, U9, UA, UB, UC, UD, UE, UF, UG
	4000	SPMWH12245Q☆W8T0SA	T0 (Whole bin)	T1, T2, T3, T4, T5, T6, T7, T8, T9, TA, TB, TC, TD, TE, TF, TG
		SPMWH12245Q☆W8TMSA	TM (Quarter bin)	T6, T7, TA, TB
		SPMWH12245Q☆W8TKSA	TK (Kitting bin)	T1, T2, T3, T4, T5, T6, T7, T8, T9, TA, TB, TC, TD, TE, TF, TG
	5000	SPMWH12245Q☆W8R0SA	R0 (Whole bin)	R1, R2, R3, R4, R5, R6, R7, R8, R9, RA, RB, RC, RD, RE, RF, RG
		SPMWH12245Q☆W8RMSA	RM (Quarter bin)	R6, R7, RA, RB
		SPMWH12245Q☆W8RKSA	RK (Kitting bin)	R1, R2, R3, R4, R5, R6, R7, R8, R9, RA, RB, RC, RD, RE, RF, RG
	5700	SPMWH12245Q☆W8Q0SA	Q0 (Whole bin)	Q1, Q2, Q3, Q4, Q5, Q6, Q7, Q8, Q9, QA, QB, QC, QD, QE, QF, QG
		SPMWH12245Q☆W8QMSA	QM (Quarter bin)	Q6, Q7, QA, QB
		SPMWH12245Q☆W8QKSA	QK (Kitting bin)	Q1, Q2, Q3, Q4, Q5, Q6, Q7, Q8, Q9, QA, QB, QC, QD, QE, QF, QG
	6500	SPMWH12245Q☆W8P0SA	P0 (Whole bin)	P1, P2, P3, P4, P5, P6, P7, P8, P9, PA, PB, PC, PD, PE, PF, PG
		SPMWH12245Q☆W8PMSA	PM (Quarter bin)	P6, P7, PA, PB
		SPMWH12245Q☆W8PKSA	PK (Kitting bin)	P1, P2, P3, P4, P5, P6, P7, P8, P9, PA, PB, PC, PD, PE, PF, PG

Note:

"☆" can be "5"(Ra 80) or "7"(Ra 90) , "

d) Voltage Bins ($I_f = 50 \text{ mA}$, $T_s = 25 \text{ °C}$)

CRI (R_a) Min.	Nominal CCT (K)	Product Code	Voltage Rank	Voltage Bin	Voltage Range (V)
-	-	-	W8	A2	16 ~ 17
-	-	-	or	A3	17 ~ 18
-	-	-	WK	A4	18 ~ 19
-	-	-		A5	19 ~ 20

e) Chromaticity Region & Coordinates ($I_f = 50\text{mA}$, $T_s = 25\text{ }^\circ\text{C}$)

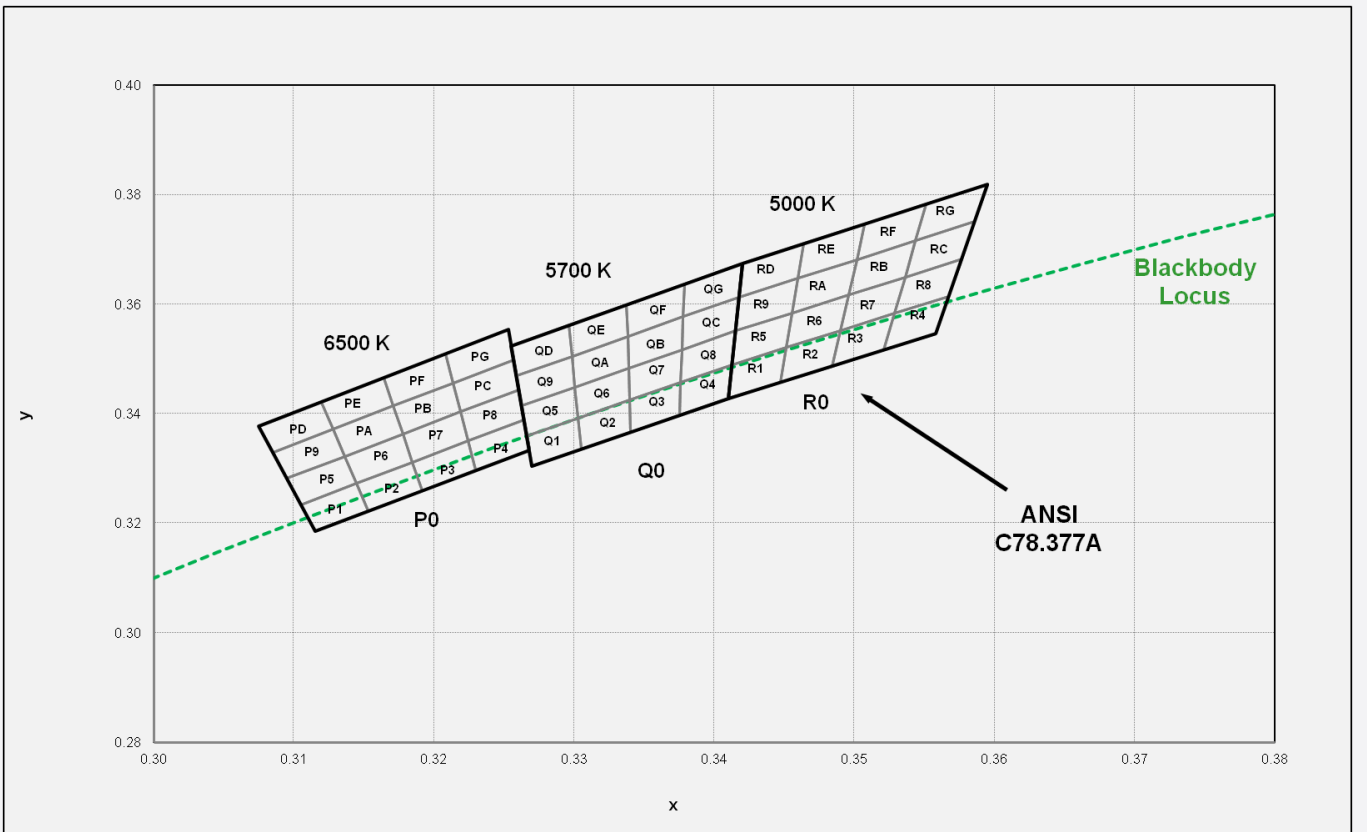
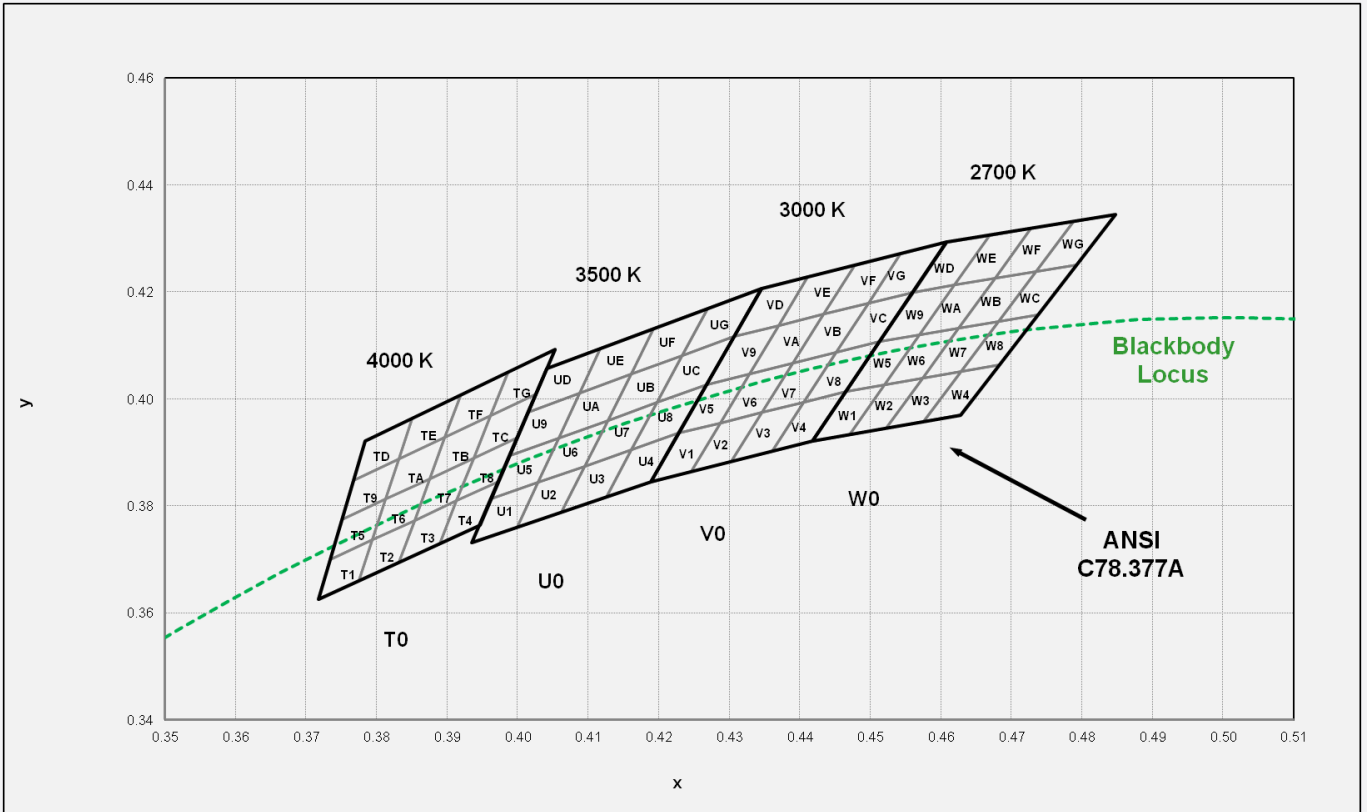

e) Chromaticity Region & Coordinates

Region	CIE x	CIE y	Region	CIE x	CIE y
W rank (2700 K)					
W1	0.4417	0.3921	W9	0.4513	0.4107
	0.4465	0.4014		0.4560	0.4200
	0.4519	0.4026		0.4618	0.4213
	0.4470	0.3933		0.4569	0.4120
W2	0.4470	0.3933	WA	0.4569	0.4120
	0.4519	0.4026		0.4618	0.4213
	0.4573	0.4039		0.4676	0.4226
	0.4522	0.3946		0.4625	0.4132
W3	0.4522	0.3946	WB	0.4625	0.4132
	0.4573	0.4039		0.4676	0.4226
	0.4628	0.4051		0.4734	0.4238
	0.4575	0.3958		0.4681	0.4145
W4	0.4575	0.3958	WC	0.4681	0.4145
	0.4628	0.4051		0.4734	0.4238
	0.4682	0.4064		0.4792	0.4251
	0.4627	0.3970		0.4737	0.4158
W5	0.4465	0.4014	WD	0.4560	0.4200
	0.4513	0.4107		0.4608	0.4293
	0.4569	0.4120		0.4668	0.4306
	0.4519	0.4026		0.4618	0.4213
W6	0.4519	0.4026	WE	0.4618	0.4213
	0.4569	0.4120		0.4668	0.4306
	0.4625	0.4132		0.4728	0.4319
	0.4573	0.4039		0.4676	0.4226
W7	0.4573	0.4039	WF	0.4676	0.4226
	0.4625	0.4132		0.4728	0.4319
	0.4681	0.4145		0.4787	0.4332
	0.4628	0.4051		0.4734	0.4238
W8	0.4628	0.4051	WG	0.4734	0.4238
	0.4681	0.4145		0.4787	0.4332
	0.4737	0.4158		0.4847	0.4345
	0.4682	0.4064		0.4792	0.4251

Region	CIE x	CIE y	Region	CIE x	CIE y
V rank (3000 K)					
V1	0.4188	0.3845	V9	0.4267	0.4026
	0.4227	0.3936		0.4306	0.4117
	0.4287	0.3955		0.4369	0.4137
	0.4245	0.3864		0.4328	0.4046
V2	0.4245	0.3864	VA	0.4328	0.4046
	0.4287	0.3955		0.4369	0.4137
	0.4346	0.3975		0.4433	0.4158
	0.4303	0.3883		0.4390	0.4067
V3	0.4303	0.3883	VB	0.4390	0.4067
	0.4346	0.3975		0.4433	0.4158
	0.4405	0.3994		0.4497	0.4179
	0.4360	0.3902		0.4451	0.4087
V4	0.4360	0.3902	VC	0.4451	0.4087
	0.4405	0.3994		0.4497	0.4179
	0.4465	0.4014		0.4560	0.4200
	0.4417	0.3921		0.4513	0.4107
V5	0.4227	0.3936	VD	0.4306	0.4117
	0.4267	0.4026		0.4345	0.4207
	0.4328	0.4046		0.4411	0.4229
	0.4287	0.3955		0.4369	0.4137
V6	0.4287	0.3955	VE	0.4369	0.4137
	0.4328	0.4046		0.4411	0.4229
	0.4390	0.4067		0.4477	0.4250
	0.4346	0.3975		0.4433	0.4158
V7	0.4346	0.3975	VF	0.4433	0.4158
	0.4390	0.4067		0.4477	0.4250
	0.4451	0.4087		0.4542	0.4272
	0.4405	0.3994		0.4497	0.4179
V8	0.4405	0.3994	VG	0.4497	0.4179
	0.4451	0.4087		0.4542	0.4272
	0.4513	0.4107		0.4608	0.4293
	0.4465	0.4014		0.4560	0.4200

e) Chromaticity Region & Coordinates

Region	CIE x	CIE y	Region	CIE x	CIE y
U rank (3500 K)					
U1	0.3935	0.3732	U9	0.3988	0.3895
	0.3962	0.3813		0.4015	0.3976
	0.4028	0.3844		0.4087	0.4011
	0.3998	0.3760		0.4058	0.3927
U2	0.3998	0.3760	UA	0.4058	0.3927
	0.4028	0.3844		0.4087	0.4011
	0.4094	0.3874		0.4160	0.4046
	0.4062	0.3789		0.4127	0.3960
U3	0.4062	0.3789	UB	0.4127	0.3960
	0.4094	0.3874		0.4160	0.4046
	0.4161	0.3905		0.4233	0.4081
	0.4125	0.3817		0.4197	0.3993
U4	0.4125	0.3817	UC	0.4197	0.3993
	0.4161	0.3905		0.4233	0.4081
	0.4227	0.3936		0.4306	0.4117
	0.4188	0.3845		0.4267	0.4026
U5	0.3962	0.3813	UD	0.4015	0.3976
	0.3988	0.3895		0.4041	0.4057
	0.4058	0.3927		0.4117	0.4095
	0.4028	0.3844		0.4087	0.4011
U6	0.4028	0.3844	UE	0.4087	0.4011
	0.4058	0.3927		0.4117	0.4095
	0.4127	0.3960		0.4193	0.4132
	0.4094	0.3874		0.4160	0.4046
U7	0.4094	0.3874	UF	0.4160	0.4046
	0.4127	0.3960		0.4193	0.4132
	0.4197	0.3993		0.4269	0.4170
	0.4161	0.3905		0.4233	0.4081
U8	0.4161	0.3905	UG	0.4233	0.4081
	0.4197	0.3993		0.4269	0.4170
	0.4267	0.4026		0.4345	0.4207
	0.4227	0.3936		0.4306	0.4117

Region	CIE x	CIE y	Region	CIE x	CIE y
T rank (4000 K)					
T1	0.3717	0.3626	T9	0.3750	0.3774
	0.3734	0.37		0.3767	0.3848
	0.3793	0.3737		0.3831	0.3889
	0.3774	0.3661		0.3812	0.3813
T2	0.3774	0.3661	TA	0.3812	0.3813
	0.3793	0.3737		0.3831	0.3889
	0.3853	0.3773		0.3896	0.3929
	0.3832	0.3695		0.3875	0.3851
T3	0.3832	0.3695	TB	0.3875	0.3851
	0.3853	0.3773		0.3896	0.3929
	0.3913	0.381		0.3961	0.3970
	0.3889	0.373		0.3937	0.3890
T4	0.3889	0.373	TC	0.3937	0.3890
	0.3913	0.381		0.3961	0.3970
	0.3973	0.3846		0.4026	0.4010
	0.3946	0.3764		0.4000	0.3928
T5	0.3734	0.37	TD	0.3767	0.3848
	0.375	0.3774		0.3783	0.3922
	0.3812	0.3813		0.3851	0.3965
	0.3793	0.3737		0.3831	0.3889
T6	0.3793	0.3737	TE	0.3831	0.3889
	0.3812	0.3813		0.3851	0.3965
	0.3875	0.3851		0.3918	0.4007
	0.3853	0.3773		0.3896	0.3929
T7	0.3853	0.3773	TF	0.3896	0.3929
	0.3875	0.3851		0.3918	0.4007
	0.3937	0.389		0.3986	0.4050
	0.3913	0.381		0.3961	0.3970
T8	0.3913	0.381	TG	0.3961	0.3970
	0.3937	0.389		0.3986	0.4050
	0.4	0.3928		0.4053	0.4092
	0.3973	0.3846		0.4026	0.401

e) Chromaticity Region & Coordinates

Region	CIE x	CIE y	Region	CIE x	CIE y
R rank (5000 K)					
R1	0.3410	0.3428	R9	0.3415	0.3552
	0.3413	0.3490		0.3418	0.3613
	0.3451	0.3521		0.3460	0.3648
	0.3447	0.3458		0.3455	0.3584
R2	0.3447	0.3458	RA	0.3455	0.3584
	0.3451	0.3521		0.3460	0.3648
	0.3490	0.3552		0.3502	0.3682
	0.3484	0.3487		0.3496	0.3617
R3	0.3484	0.3487	RB	0.3496	0.3617
	0.3490	0.3552		0.3502	0.3682
	0.3529	0.3583		0.3544	0.3716
	0.3521	0.3517		0.3536	0.3650
R4	0.3521	0.3517	RC	0.3536	0.3650
	0.3529	0.3583		0.3544	0.3716
	0.3567	0.3614		0.3586	0.3751
	0.3558	0.3546		0.3577	0.3683
R5	0.3413	0.3490	RD	0.3418	0.3613
	0.3415	0.3552		0.3420	0.3675
	0.3455	0.3584		0.3464	0.3711
	0.3451	0.3521		0.3460	0.3648
R6	0.3451	0.3521	RE	0.3460	0.3648
	0.3455	0.3584		0.3464	0.3711
	0.3496	0.3617		0.3508	0.3747
	0.3490	0.3552		0.3502	0.3682
R7	0.3490	0.3552	RF	0.3502	0.3682
	0.3496	0.3617		0.3508	0.3747
	0.3536	0.3650		0.3551	0.3783
	0.3529	0.3583		0.3544	0.3716
R8	0.3529	0.3583	RG	0.3544	0.3716
	0.3536	0.3650		0.3551	0.3783
	0.3577	0.3683		0.3595	0.3819
	0.3567	0.3614		0.3586	0.3751

Region	CIE x	CIE y	Region	CIE x	CIE y
Q rank (5700 K)					
Q1	0.3270	0.3305	Q9	0.3263	0.3415
	0.3266	0.3360		0.3259	0.3469
	0.3303	0.3392		0.3298	0.3505
	0.3305	0.3336		0.3301	0.3449
Q2	0.3305	0.3336	QA	0.3301	0.3449
	0.3303	0.3392		0.3298	0.3505
	0.3339	0.3425		0.3338	0.3541
	0.3340	0.3367		0.3339	0.3483
Q3	0.3340	0.3367	QB	0.3339	0.3483
	0.3339	0.3425		0.3338	0.3541
	0.3376	0.3457		0.3378	0.3577
	0.3375	0.3397		0.3377	0.3517
Q4	0.3375	0.3397	QC	0.3377	0.3517
	0.3376	0.3457		0.3378	0.3577
	0.3413	0.3490		0.3418	0.3613
	0.3410	0.3428		0.3415	0.3552
Q5	0.3266	0.3360	QD	0.3259	0.3469
	0.3263	0.3415		0.3255	0.3524
	0.3301	0.3449		0.3296	0.3562
	0.3303	0.3392		0.3298	0.3505
Q6	0.3303	0.3392	QE	0.3298	0.3505
	0.3301	0.3449		0.3296	0.3562
	0.3339	0.3483		0.3338	0.3600
	0.3339	0.3425		0.3338	0.3541
Q7	0.3339	0.3425	QF	0.3338	0.3541
	0.3339	0.3483		0.3338	0.3600
	0.3377	0.3517		0.3379	0.3637
	0.3376	0.3457		0.3378	0.3577
Q8	0.3376	0.3457	QG	0.3378	0.3577
	0.3377	0.3517		0.3379	0.3637
	0.3415	0.3552		0.3420	0.3675
	0.3413	0.3490		0.3418	0.3613

e) Chromaticity Region & Coordinates

Region	CIE x	CIE y	Region	CIE x	CIE y
P rank (6500 K)					
P1	0.3115	0.3186	P9	0.3095	0.3282
	0.3105	0.3234		0.3085	0.3329
	0.3145	0.3273		0.3128	0.3372
	0.3153	0.3223		0.3136	0.3322
P2	0.3153	0.3223	PA	0.3136	0.3322
	0.3145	0.3273		0.3128	0.3372
	0.3185	0.3311		0.3171	0.3414
	0.3192	0.326		0.3178	0.3363
P3	0.3192	0.326	PB	0.3178	0.3363
	0.3185	0.3311		0.3171	0.3414
	0.3224	0.335		0.3214	0.3457
	0.323	0.3297		0.3219	0.3403
P4	0.323	0.3297	PC	0.3219	0.3403
	0.3224	0.335		0.3214	0.3457
	0.3264	0.3389		0.3257	0.3499
	0.3268	0.3334		0.3261	0.3444
P5	0.3105	0.3234	PD	0.3085	0.3329
	0.3095	0.3282		0.3075	0.3377
	0.3136	0.3322		0.3120	0.3421
	0.3145	0.3273		0.3128	0.3372
P6	0.3145	0.3273	PE	0.3128	0.3372
	0.3136	0.3322		0.3120	0.3421
	0.3178	0.3363		0.3164	0.3466
	0.3185	0.3311		0.3171	0.3414
P7	0.3185	0.3311	PF	0.3171	0.3414
	0.3178	0.3363		0.3164	0.3466
	0.3219	0.3403		0.3209	0.3510
	0.3224	0.335		0.3214	0.3457
P8	0.3224	0.335	PG	0.3214	0.3457
	0.3219	0.3403		0.3209	0.3510
	0.3261	0.3444		0.3253	0.3554
	0.3264	0.3389		0.3257	0.3499

Note: Samsung maintains measurement tolerance of: Cx, Cy = ±0.005

3. Typical Characteristics Graphs

a) Spectrum Distribution ($I_f = 50 \text{ mA}$, $T_s = 25 \text{ }^\circ\text{C}$)

CCT: 2700 K (80 CRI)

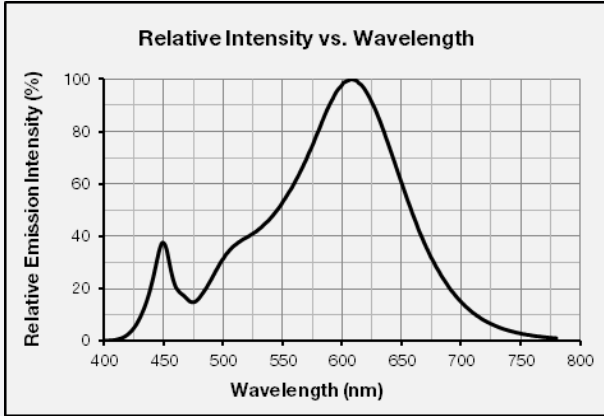

CCT: 3000 K (80 CRI)

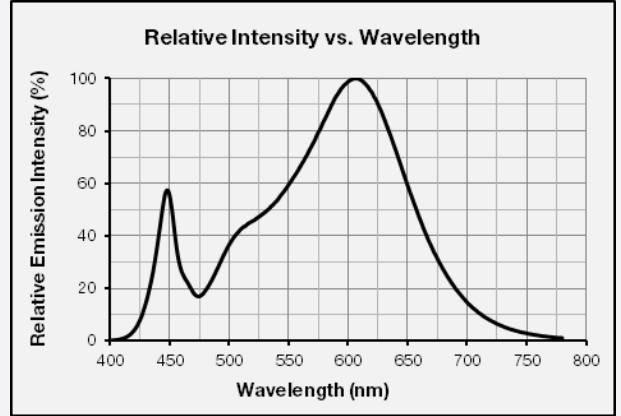

CCT: 3500 K (80 CRI)

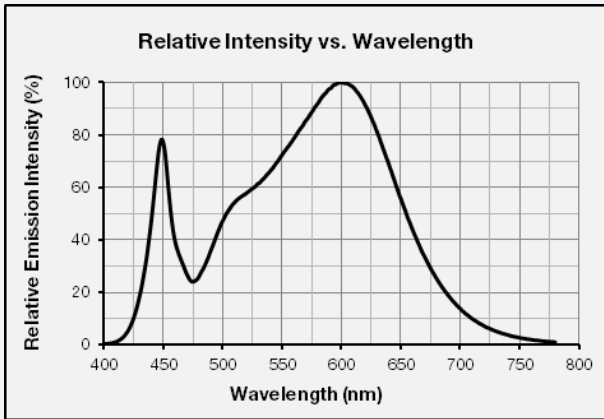

CCT: 4000 K (80 CRI)

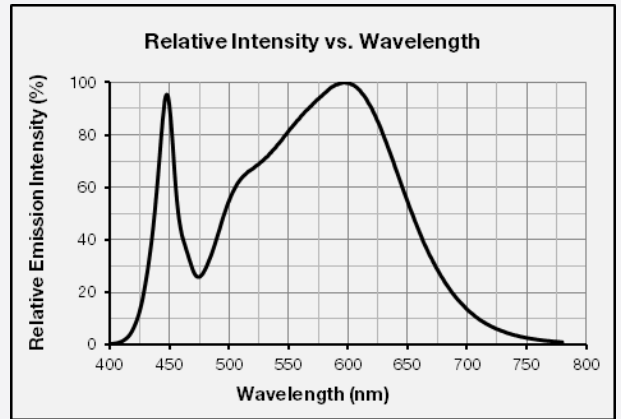

CCT: 5000 K (80 CRI)

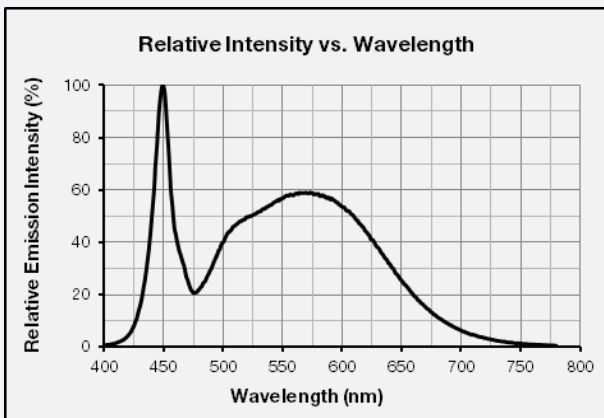

CCT: 5700 K (80 CRI)

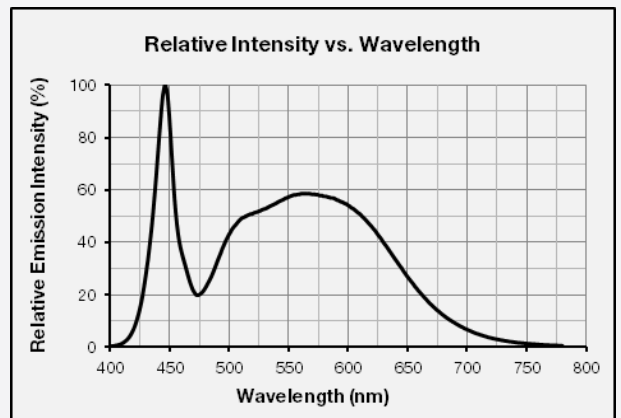

CCT: 6500 K (80 CRI)

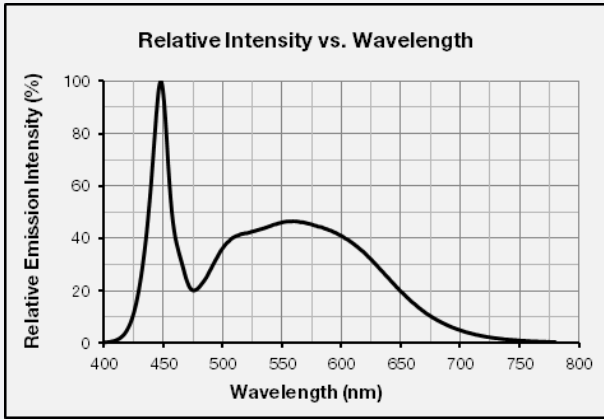

CCT: 2700 K (90 CRI)

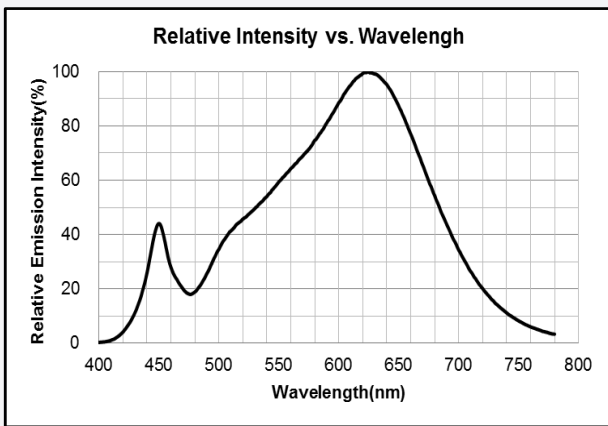

CCT: 3000 K (90 CRI)

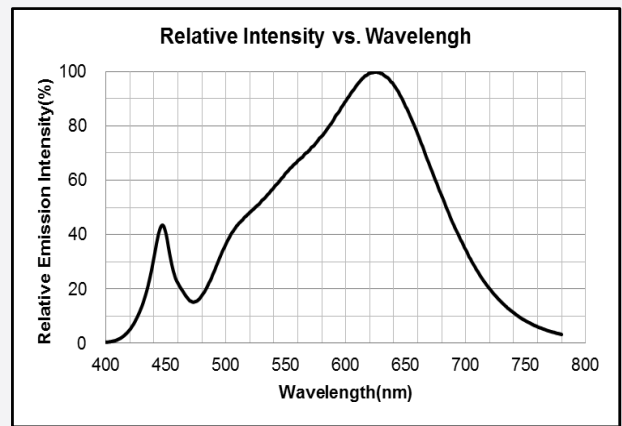

CCT: 3500 K (90 CRI)

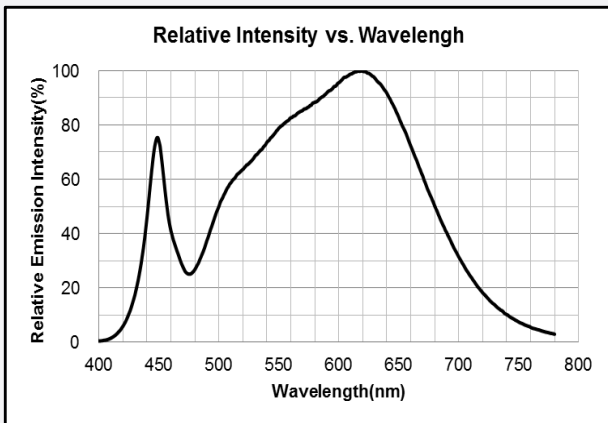

CCT: 4000 K (90 CRI)

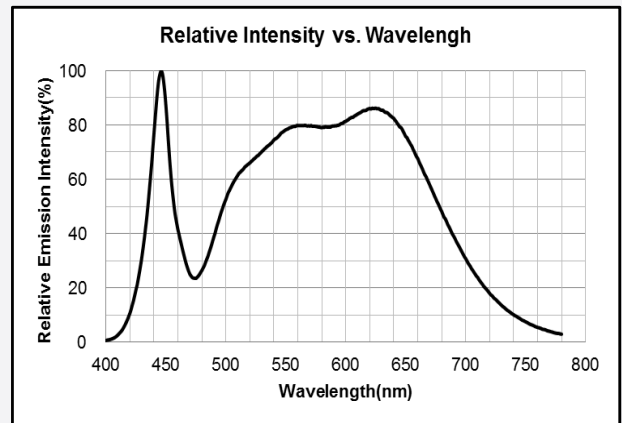

CCT: 5000 K (90 CRI)

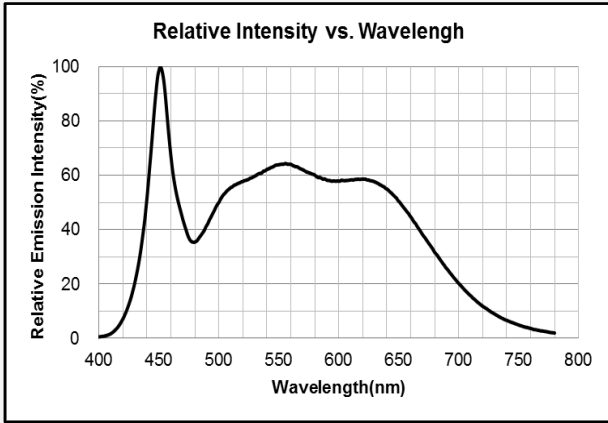

CCT: 5700 K (90 CRI)

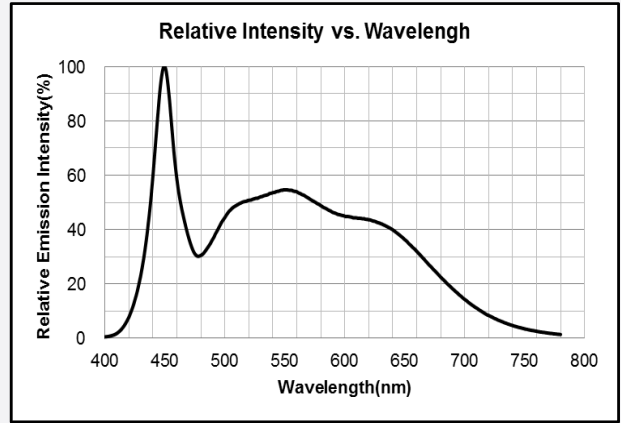

CCT: 6500 K (90 CRI)

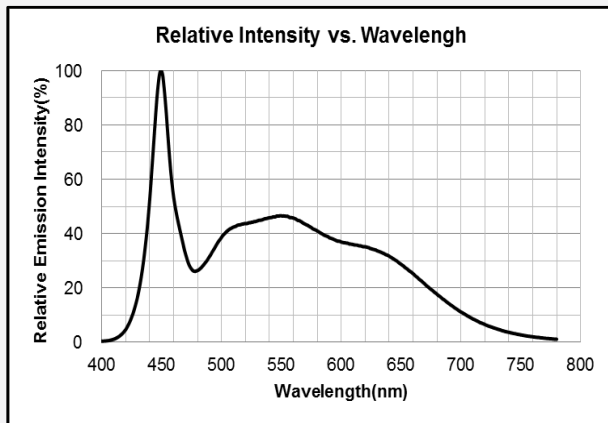

b) Forward Current Characteristics ($T_s = 25\text{ }^\circ\text{C}$)

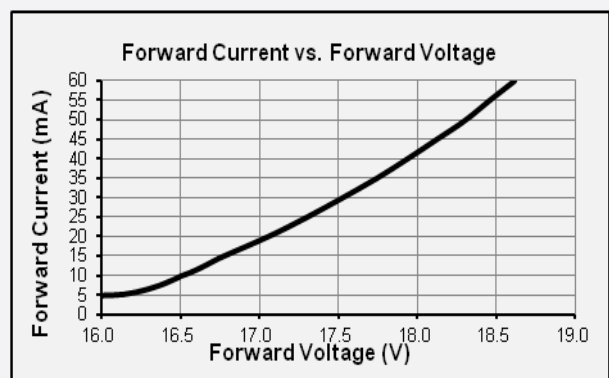
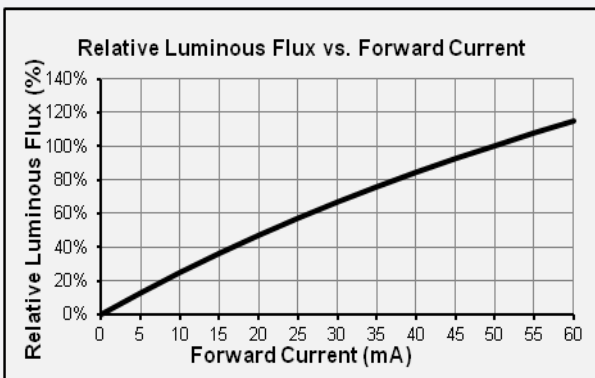

c) Temperature Characteristics ($I_F = 50 \text{ mA}$)

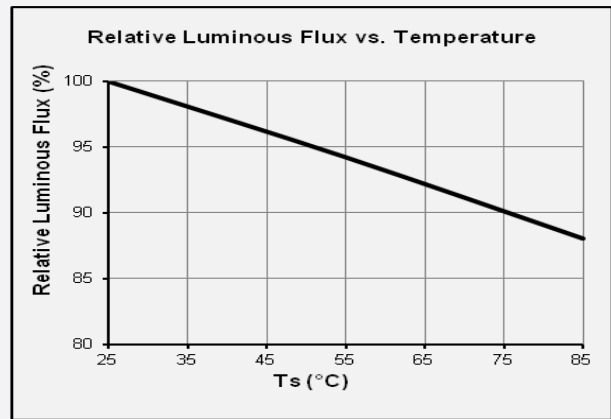
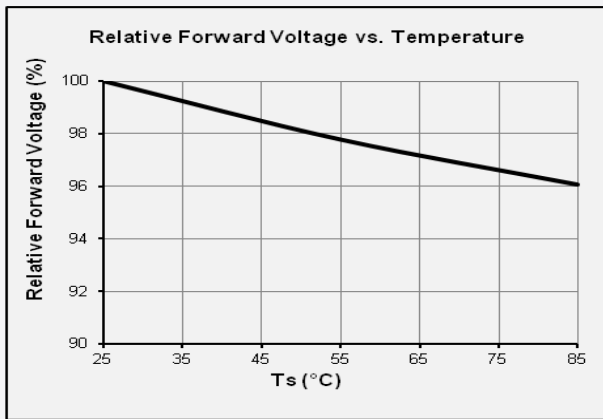

d) Color Shift Characteristics ($I_F = 50 \text{ mA}$, $T_s = 25 \text{ °C}$)

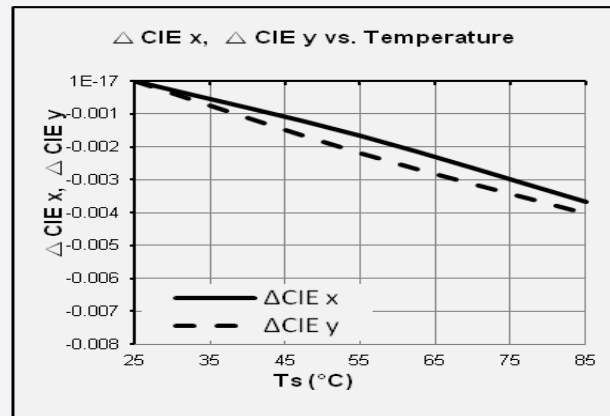
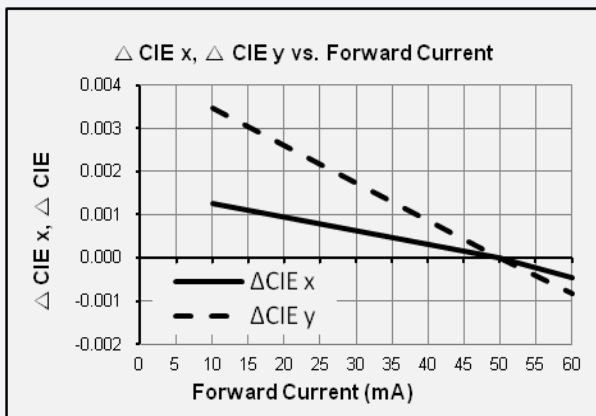

e) Derating Curve

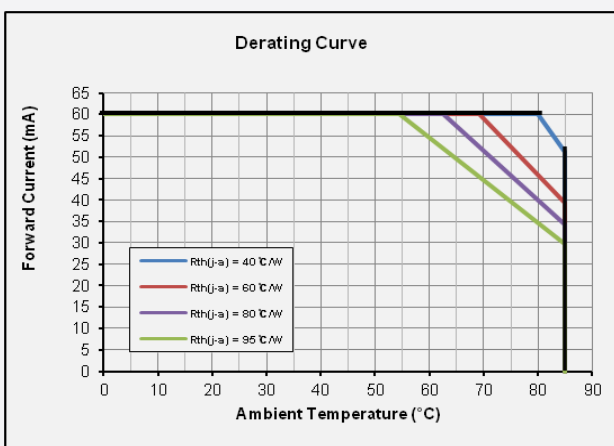

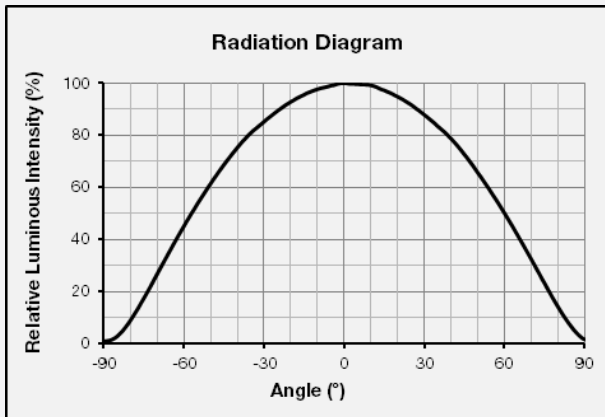
f) Beam Angle Characteristics ($I_f = 50 \text{ mA}$, $T_s = 25 \text{ }^\circ\text{C}$)

4. Outline Drawing & Dimension

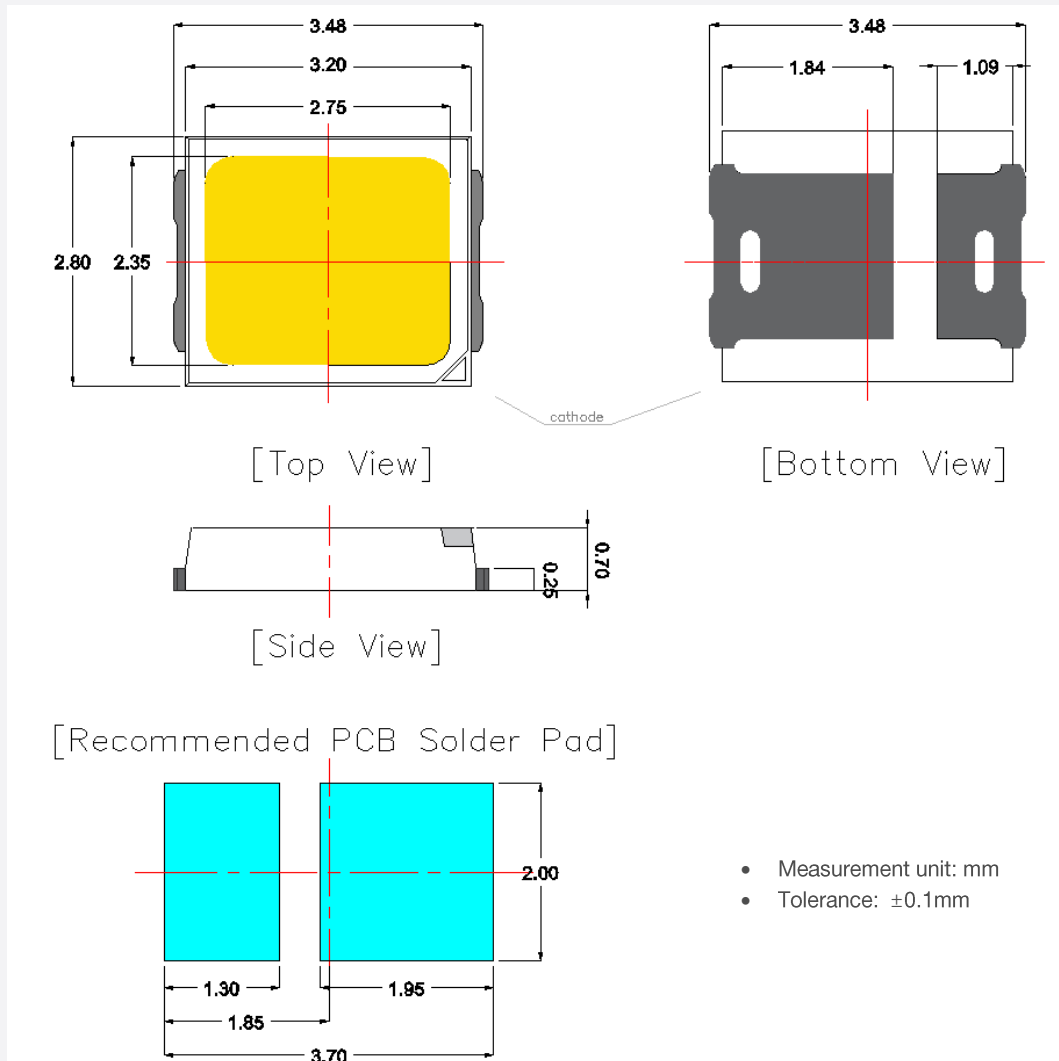

Notes:

- 1) T_s point and measurement method:
 - ① Measure one point at the cathode pad, if necessary remove PSR of PCB to reach T_s point.
 - ② All pads must be soldered to the PCB to dissipate heat properly, otherwise the LED can be damaged.

Precautions:

- 1) Pressure on the LEDs will influence to the reliability of the LEDs. Precautions should be taken to avoid strong pressure on the LEDs. Do not put stress on the LEDs during heating.
- 2) Re-soldering should not be done after the LEDs have been soldered. If re-soldering is unavoidable, LED's characteristics should be carefully checked before and after such repair.
- 3) Do not stack assembled PCBs together. Since materials of LEDs is soft, abrasion between two PCB assembled with LED might cause catastrophic failure of the LEDs.

5. Reliability Test Items & Conditions

a) Test Items

Test Item	Test Condition	Test Hour / Cycle	Sample No.
Room Temperature Life Test	25 °C, DC 60 mA	1000 h	22
High Temperature Life Test	85 °C, DC 60 mA	1000 h	22
High Temperature Humidity Life Test	85 °C, 85 % RH, DC 60 mA	1000 h	22
Low Temperature Life Test	-40 °C, DC 60 mA	1000 h	22
Powered Temperature Cycle Test	-45 °C ~ 85 °C, each 20 min, on/off 5 min Temp. Change time 100min, DC 60 mA	100 cycles	22
Temperature Cycle	-45°C / 15 min ↔ 125 °C / 15 min	200 cycles	100
High Temperature Storage	85 °C	1000 h	11
Low Temperature Storage	-40 °C	1000 h	11

ESD (HBM)

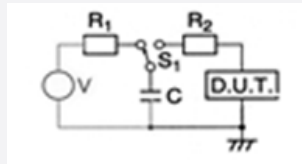

R_1 : 10 M Ω
 R_2 : 1.5 k Ω
 C : 100 pF
 V : ± 2 kV

5 times

30

b) Criteria for Judging the Damage

Item	Symbol	Test Condition ($T_s = 25$ °C)	Limit	
			Min	Max
Forward Voltage	V_F	$I_F = 50$ mA	Init. Value * 0.9	Init. Value * 1.1
Luminous Flux	Φ_v	$I_F = 50$ mA	Init. Value * 0.7	Init. Value * 1.1

6. Soldering Conditions

a) Reflow Conditions (Pb free)

Reflow frequency: 2 times max.

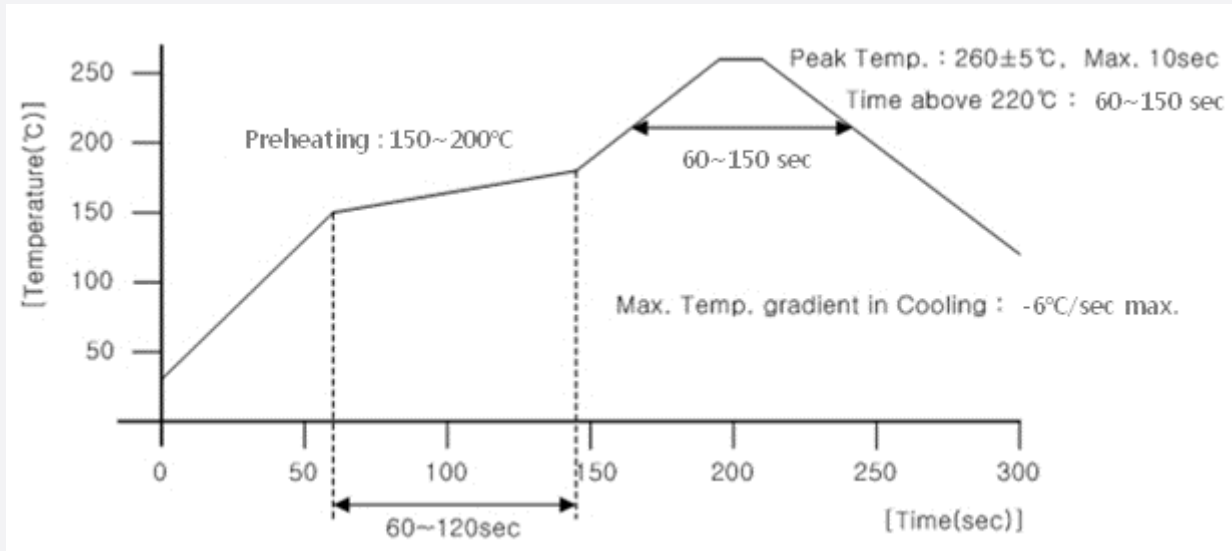

b) Manual Soldering Conditions

Not more than 5 seconds @ max. 300 °C, under soldering iron.

7. Tape & Reel

a) Taping Dimension

(unit: mm)

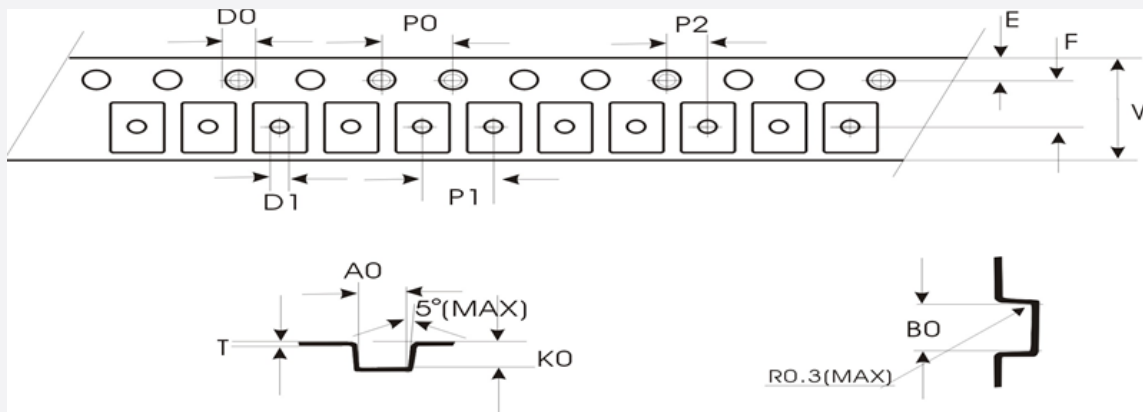

A0	3.10±0.1	P0	4.00±0.1	T	0.20±0.05	D0	1.60(MAX)
B0	3.70±0.1	P1	4.00±0.1	E	1.75±0.1	D1	1.05(MIN)
K0	1.00±0.1	P2	2.00±0.1	F	3.50±0.05	V	8.00±0.1

b) Reel Dimension (max 4,000 pcs)

(unit: mm)

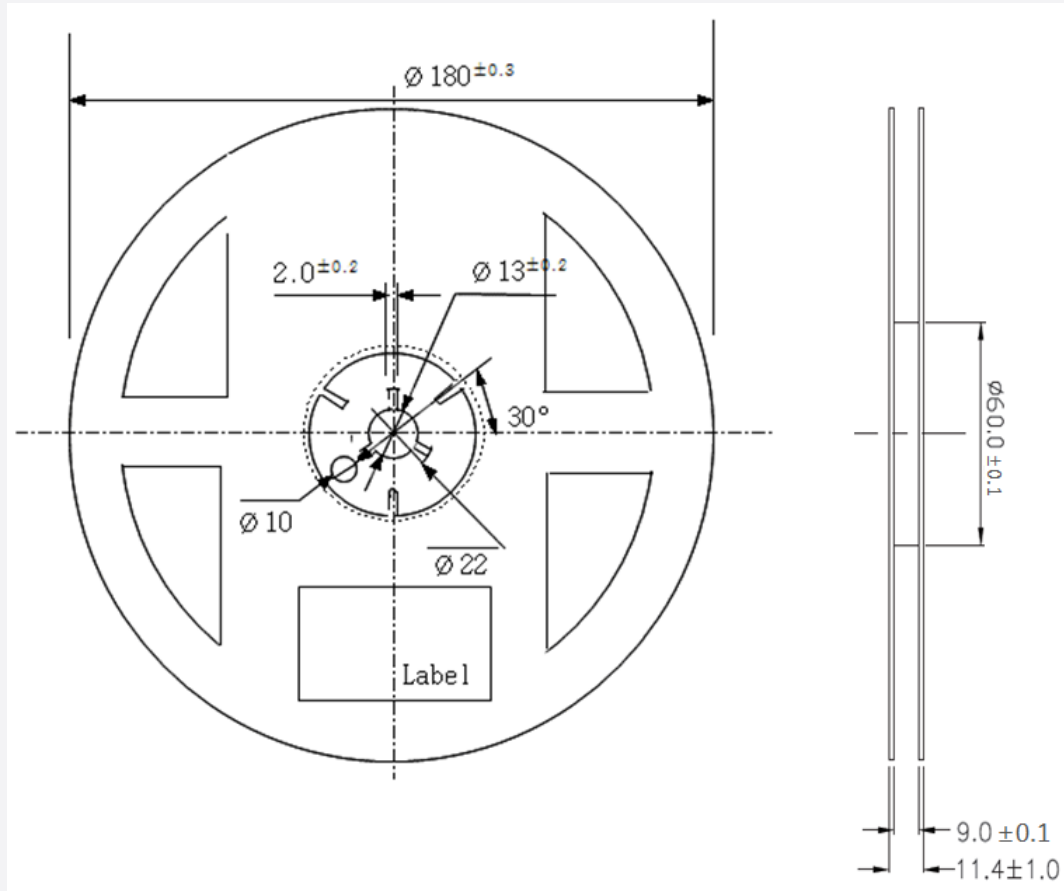
**Notes:**

- 1) Quantity: The quantity/reel is 4,000 pcs
- 2) All dimensions are millimeters (tolerance : $\pm 0.2\text{mm}$)
- 3) Packaging: P/N, Manufacturing data code no. and quantity are indicated on the aluminum packing bag

c) Reel Dimension (max 16,000 pcs)

(unit: mm)

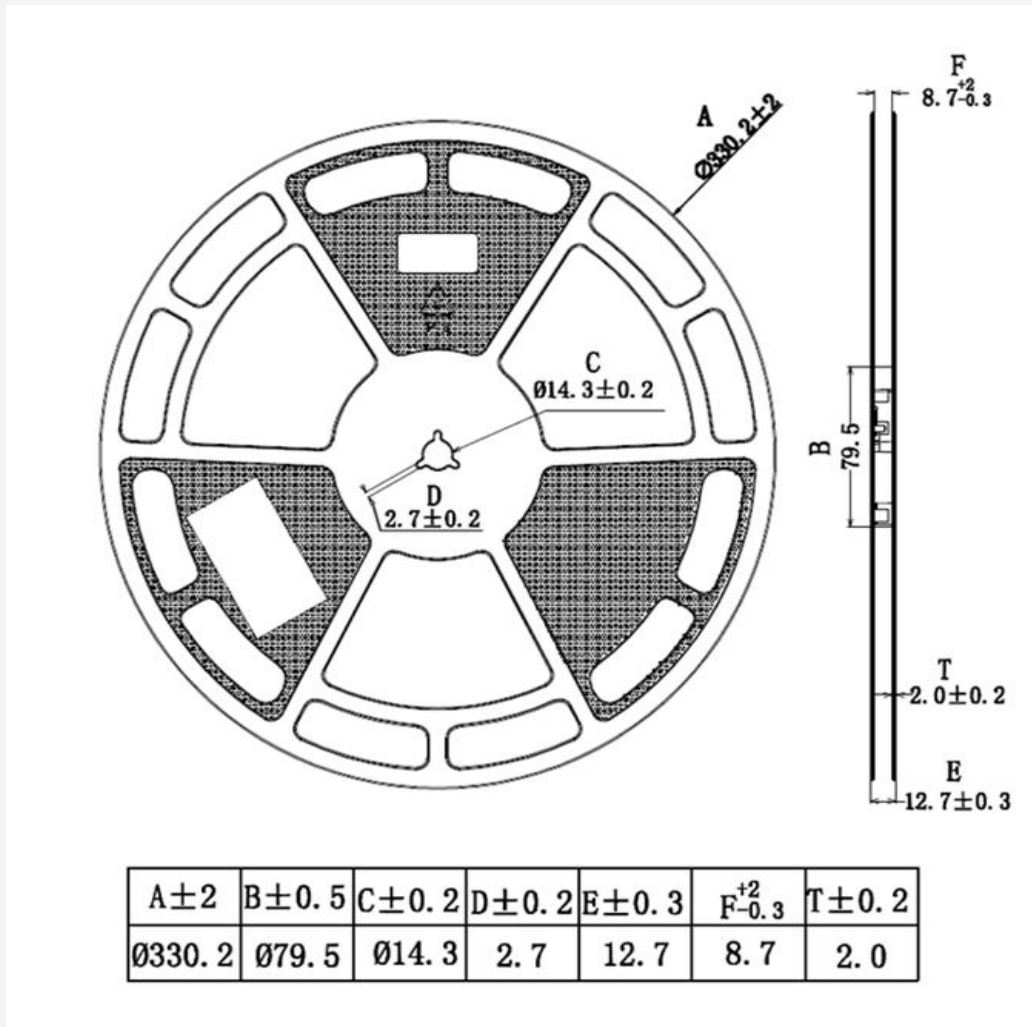

Notes:

- 1) Quantity: The quantity/reel is 16,000 pcs
- 2) All dimensions are millimeters (tolerance : ±0.2mm)
- 3) Packaging: P/N, Manufacturing data code no. and quantity are indicated on the aluminum packing bag

8. Label Structure

a) Label Structure

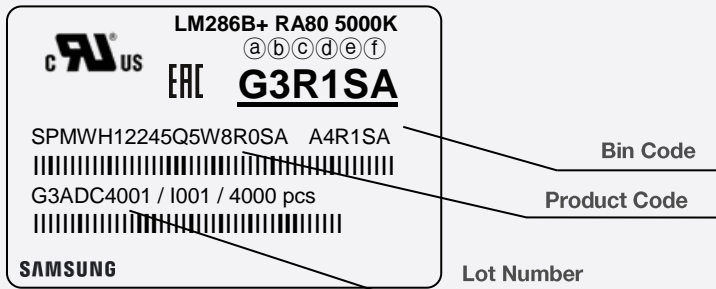

Note: Denoted bin code and product code above is only an example (see description on page 6)

Bin Code:

- ⒶⒷ: Forward Voltage bin (refer to page 10)
- ⒸⒹ: Chromaticity bin (refer to page 11~18)
- ⒺⒻ: Luminous Flux bin (refer to page 7)

b) Lot Number

The lot number is composed of the following characters:



①②③④⑤⑥⑦⑧⑨ / 1ⒶⒷⒸ / 4,000 pcs

- ①② : Production site (G3 or GP : Shenzhen, China)
- ③ : Product state (A: Normal, B: Bulk, C: First Production, R: Reproduction, S: Sample)
- ④ : Year (C: 2018, D: 2019. E: 2020...)
- ⑤ : Month (1~9, A, B, C)
- ⑥ : Day (1~9, A, B~V)
- ⑦⑧⑨ ⒶⒷⒸ : Product serial number

9. Packing Structure

a) Packing Process (The quantity of PKG on the Reel to be Max 4,000 pcs)

Reel

LM286B+ RA80 5000K
ERC A4R1SA
 SPMWH12245Q5W8R0SA A4R1SA
 G3ADC4001 / I0AA / 4000 pcs
SAMSUNG

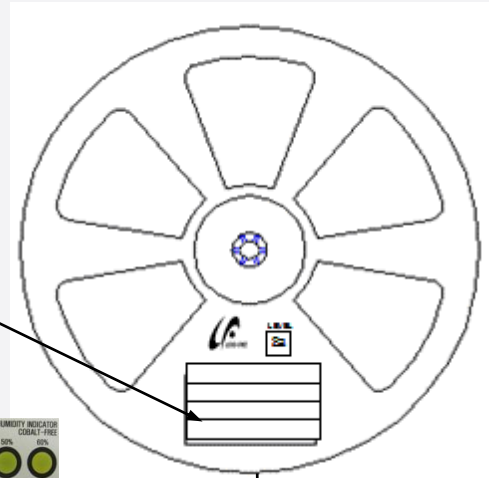

Aluminum Vinyl Packing Bag

LM286B+ RA80 5000K
ERC A4R1SA
 SPMWH12245Q5W8R0SA A4R1SA
 G3ADC4001 / I0AA / 4000 pcs
SAMSUNG



Outer Box

Material: Paper (SW3B(B))

Type	Size (mm)			Note
	L	W	H	
7 inch L	245 ± 5	220 ± 5	182 ± 5	Up to 10 reels
7 inch S	245 ± 5	220 ± 5	86 ± 5	Up to 5 reels

① Side Label

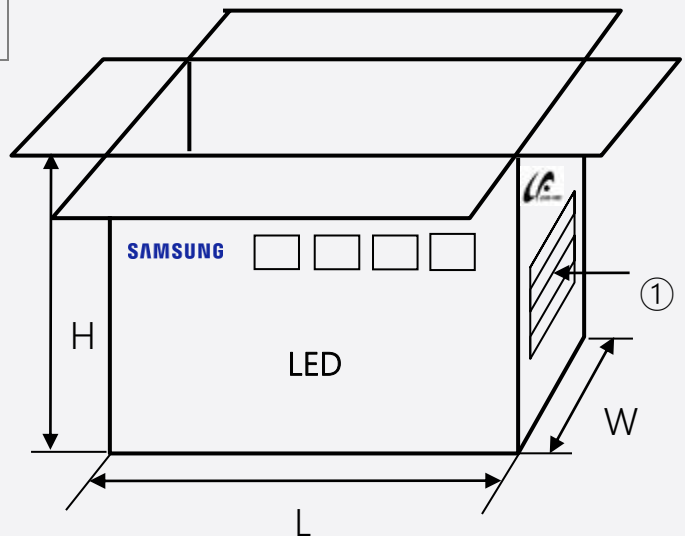

LM286B+ RA80 5000K
ERC A4R1SA
 SPMWH12245Q5W8R0SA A4R1SA
 G3ADC4001 / I0AA / 4000 pcs
SAMSUNG



b) Packing Process (The quantity of PKG on the Reel to be Max 16,000 pcs)

Reel

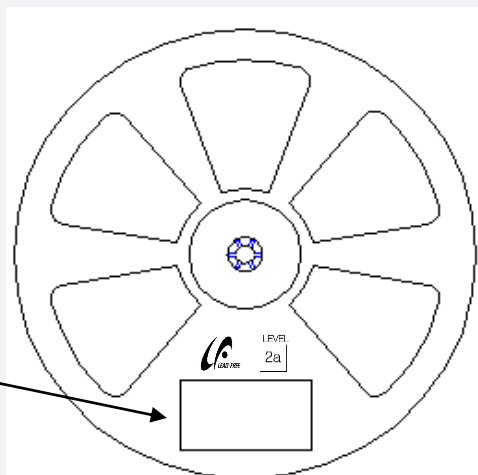
LM286B+ RA80 5000K
ERC A4R1SA
 SPMWH12245Q5WKR0SA A4R1SA
 G3ADC4001 / IOAA / 16000 pcs
SAMSUNG



Aluminum Vinyl Packing Bag

LM286B+ RA80 5000K
ERC A4R1SA
 SPMWH12245Q5WKR0SA A4R1SA
 G3ADC4001 / IOAA / 16000 pcs
SAMSUNG



Outer Box

LM286B+ RA80 5000K
ERC A4R1SA
 SPMWH12245Q5WKR0SA A4R1SA
 G3ADC4001 / IOAA / 480000 pcs
SAMSUNG

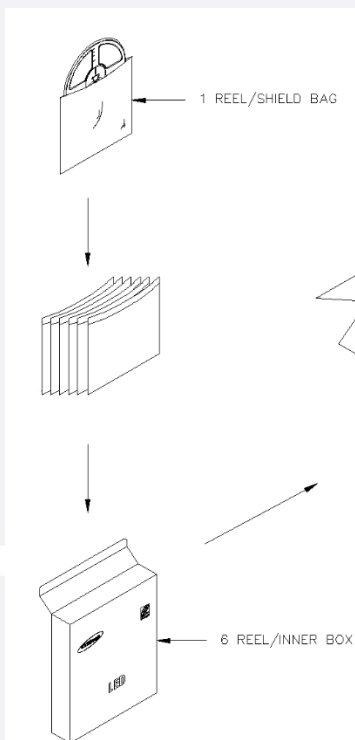

c) Packing Process for kitting (The quantity of PKG on the Reel to be Max 4,000 pcs)

Reel

Kitting 'A'

LM286B+ RA80 ★K

 SPMWH12245Q5W8★KSA A3★1SA
 G3ADC4001 / IOAA / 4,000 pcs
SAMSUNG

Kitting 'B'

LM286B+ RA80 ★K

 SPMWH12245Q5W8★KSA A3★1SA
 G3ADC4001 / IOAA / 4,000 pcs
SAMSUNG

Kitting 'A'

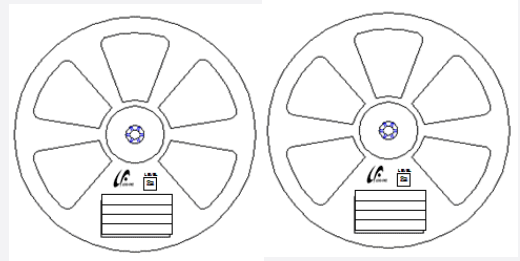
Kitting 'B'



Aluminum Vinyl Packing Bag

Kitting 'A'

LM286B+ RA80 ★K

 SPMWH12245Q5W8★KSA A3★1SA
 G3ADC4001 / IOAA / 4,000 pcs
SAMSUNG

Kitting 'B'

LM286B+ RA80 ★K

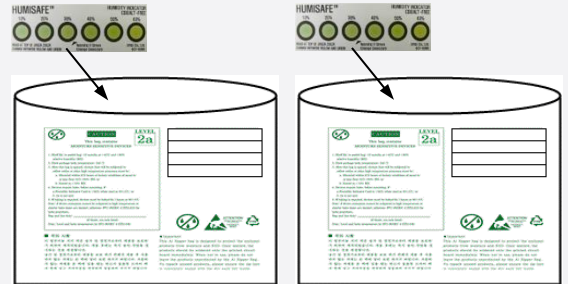
 SPMWH12245Q5W8★KSA A3★CSA
 G3ADC4001 / IOAA / 4,000 pcs
SAMSUNG



Outer Box

Kitting 'A'

LM286B+ RA80 ★K

 SPMWH12245Q5W8★KSA A3★1SA
 G3ADC4001 / IOAA / 20,000 pcs
SAMSUNG [BOX Label]

Kitting 'B'

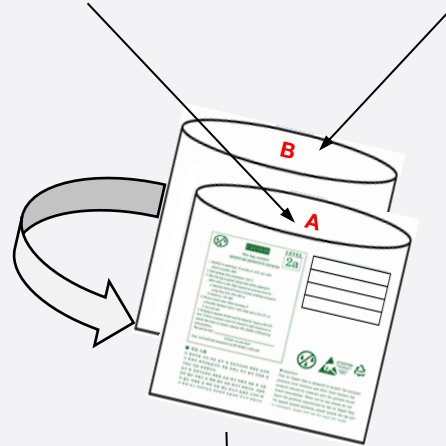
LM286B+ RA80 ★K

 SPMWH12245Q5W8★KSA A3★CSA
 G3ADC4001 / IOAA / 20,000 pcs
SAMSUNG [BOX Label]

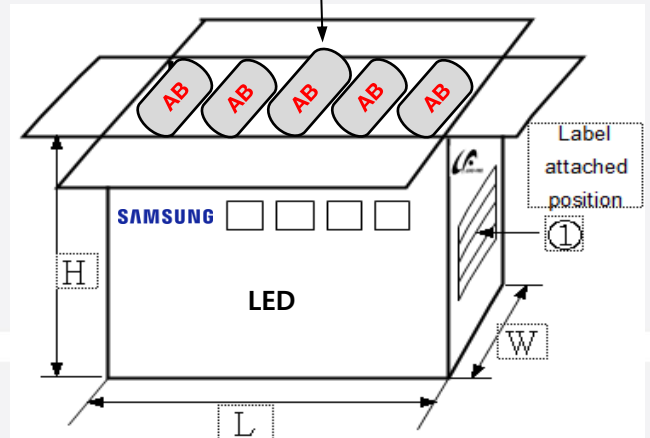

Material: Paper (SW3B(B))

Type	Size (mm)			Note
	L	W	H	
7 inch L	245 ± 5	220 ± 5	182 ± 5	Up to 10 reels



d) Packing Process for kitting (The quantity of PKG on the Reel to be Max 16,000 pcs)

Reel

Kitting 'A'

LM286B+ RA80 ★K

 SPMWH12245Q5WK★KSA A3★1SA
 G3ADC4001 / IOAA / 16,000 pcs
SAMSUNG

Kitting 'B'

LM286B+ RA80 ★K

 SPMWH12245Q5WK★KSA A3★1SA
 G3ADC4001 / IOAA / 16,000 pcs
SAMSUNG

Kitting 'A'

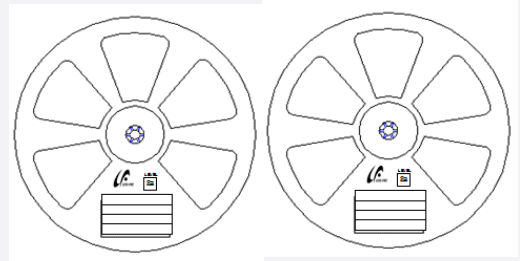
Kitting 'B'



Aluminum Vinyl Packing Bag

Kitting 'A'

LM286B+ RA80 ★K

 SPMWH12245Q5WK★KSA A3★1SA
 G3ADC4001 / IOAA / 16,000 pcs
SAMSUNG

Kitting 'B'

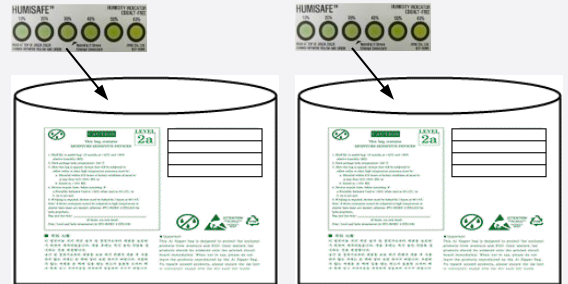
LM286B+ RA80 ★K

 SPMWH12245Q5WK★KSA A3★1SA
 G3ADC4001 / IOAA / 16,000 pcs
SAMSUNG



Outer Box

Kitting 'A'

LM286B+ RA80 ★K

 SPMWH12245Q5WK★KSA A3★1SA
 G3ADC4001 / IOAA / 80,000 pcs
SAMSUNG [BOX Label]

Kitting 'B'

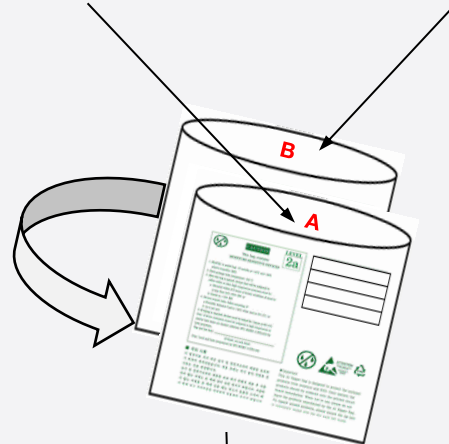
LM286B+ RA80 ★K

 SPMWH12245Q5WK★KSA A3★1SA
 G3ADC4001 / IOAA / 80,000 pcs
SAMSUNG [BOX Label]

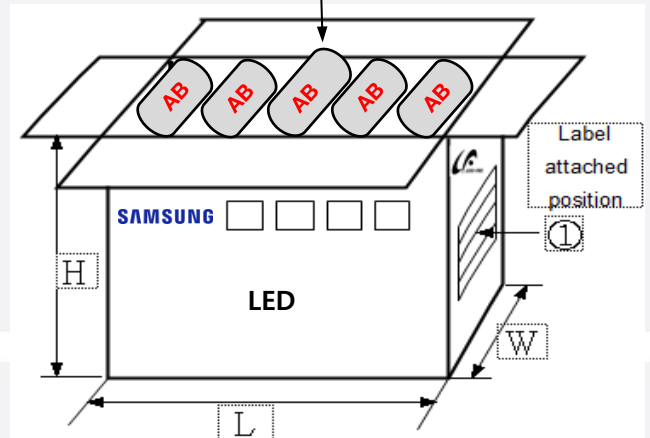

Material: Paper (SW3B(B))

Type	Size (mm)			Note
	L	W	H	
13 inch	378 ± 5	345 ± 5	405 ± 5	Up to 10 reels



e) Aluminum Vinyl Packing Bag



CAUTION

This bag contains
MOISTURE SENSITIVE DEVICES

LEVEL

2a

LM286B+ RA80 5000K



A4R1SA

SPMWH12245Q5WAR0SA A4R1SA

G3ADC4001 / IOAA / 4000 pcs

SAMSUNG





주의 사항

이 알루미늄 지퍼 백은 습기 및 정전기로부터 제품을 보호하기 위하여 제작되었습니다. 개봉 후에는 즉시 솔더 작업을 실시하는 것을 권장합니다.

습기 및 정전기로부터 제품을 보호 하기 위해서 개봉 후 사용하지 않는 자재는 본 팩에 넣어 보관 하시기 바랍니다. 사용하지 않는 자재를 본 팩에 넣을 때는 반드시 동봉된 드라이 팩과 함께 넣고 지퍼부분을 완전하게 밀봉하여 주시기 바랍니다.

Important

This Al Zipper bag is designed to protect the enclosed products from moisture and ESD. Once opened, the products should be soldered onto the printed circuit board immediately. When not in use, please do not leave the products unprotected by the Al Zipper Bag. To repack unused products., please ensure the zip-lock is completely sealed with the dry pack left inside.

f) Humidity Indicator Card inside Aluminum Vinyl Bag

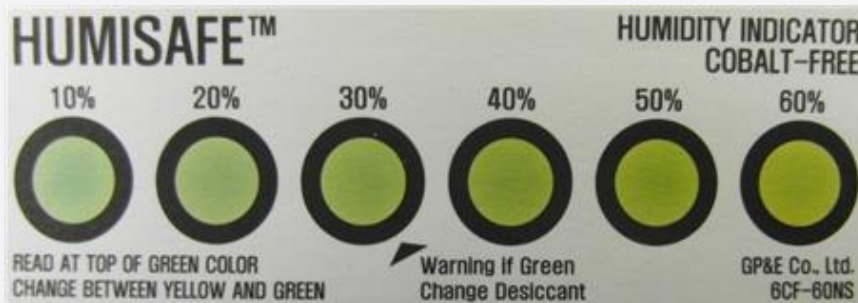

10. Precautions in Handling & Use

- 1) For over-current protection, users are recommended to apply resistors connected in series with the LEDs to mitigate sudden change of the forward current caused by shift of forward voltage.
- 2) This device should not be used in any type of fluid such as water, oil, organic solvent, etc. When cleaning is required, IPA is recommended as the cleaning agent. Some solvent-based cleaning agent may damage the silicone resins used in the device.
- 3) When the device is in operation, the forward current should be carefully determined considering the maximum ambient temperature and corresponding junction temperature.
- 4) LEDs must be stored in a clean environment.
(Shelf life of sealed bags is 12 months at temperature 0~40 °C, 0~90 % RH).
- 5) After storage bag is opened, device subjected to soldering, solder reflow, or other high temperature processes must be:
 - a. Mounted within 672 hours (28 days) at an assembly line with a condition of no more than 30 °C / 60 % RH^{*Note 1}, or
 - b. Mounted within 24 hours (1 day) at an assembly line with a condition of more than 30 °C / 70 % RH^{*Note 2}, or
 - c. Stored at <10 % RH.

*Note 1, 2: IPC/JEDEC J-STD-033A, Recommended Equivalent Total Floor Life Table

Package Type and Body Thickness	Moisture Sensitivity Level	Maximum Percent Relative Humidity						Temperature
		40%	50%	60%	70%	80%	90%	
Body Thickness <2.1mm	Level 2a	∞	∞	28	1	1	1	30°C
		∞	∞	∞	2	1	1	25°C
		∞	∞	∞	2	2	1	20°C

- 6) Repack unused devices with anti-moisture packing, fold to close any opening and then store in a dry place.
- 7) Devices require baking before mounting, if humidity card reading is >60 % at 23 ± 5 °C.
- 8) Devices must be baked for 10~24 hours at 60 ± 5 °C, if baking is required.
- 9) The LEDs are sensitive to the static electricity and surge current. It is recommended to use a wrist band or anti-electrostatic glove when handling the LEDs. If voltage exceeding the absolute maximum rating is applied to LEDs, it may cause damage or even destruction to LED devices. Damaged LEDs may show some unusual characteristics such as increase in leakage current, lowered turn-on voltage, or abnormal lighting of LEDs at low current.
- 10) VOCs (Volatile Organic Compounds) can be generated from adhesives, flux, hardener or organic additives used in luminaires (fixtures). Transparent LED silicone encapsulant is permeable to those chemicals and they may lead to a discoloration of encapsulant when they exposed to heat or light. This phenomenon can cause a significant loss of light emitted (output) from the luminaires. In order to prevent these problems, we recommend users to know the physical properties of materials used in luminaires and they must be carefully selected.
- 11) Risk of sulfurization (or tarnishing)
The LED from Samsung uses a silver-plated lead frame and its surface color may change to black (or dark colored) when it is exposed to sulfur (S), chlorine (Cl) or other halogen compound. Sulfurization of lead frame may cause intensity degradation, change of chromaticity coordinates and, in extreme cases, open circuit. It requires caution. Due to possible sulfurization of lead frame, LED should not be used and stored together with oxidizing substances made of materials such as rubber, plain paper, lead solder cream, etc.

Legal and additional information.

[About Samsung Electronics Co., Ltd.](#)

Samsung inspires the world and shapes the future with transformative ideas and technologies. The company is redefining the worlds of TVs, smartphones, wearable devices, tablets, digital appliances, network systems, and memory, system LSI, foundry and LED solutions. For the latest news, please visit the Samsung Newsroom at news.samsung.com.

Copyright © 2020 Samsung Electronics Co., Ltd. All rights reserved.
Samsung is a registered trademark of Samsung Electronics Co., Ltd.
Specifications and designs are subject to change without notice. Non-metric weights and measurements are approximate. All data were deemed correct at time of creation. Samsung is not liable for errors or omissions. All brand, product, service names and logos are trademarks and/or registered trademarks of their respective owners and are hereby recognized and acknowledged.

Samsung Electronics Co., Ltd.
95, Samsung 2-ro
Giheung-gu
Yongin-si, Gyeonggi-do, 446-711
KOREA

www.samsungled.com

SAMSUNG